

LAND AT TOLLGATE ROAD COLNEY HEATH

Transport Assessment

JNY11289-02b
Transport Assessment
Version 02b
29 June 2022

Document Status

Version	Purpose of document	Authored by	Reviewed by	Approved by	Review date
-	Information	Matthew Brown	Ian Dimbylow	Ian Dimbylow	31 May 2022
02a	Information	Matthew Brown	Ian Dimbylow	Ian Dimbylow	27 June 2022
02b	Information	Matthew Brown	Ian Dimbylow	Ian Dimbylow	29 June 2022

This report was prepared by **RPS Consulting Services Ltd** ('RPS') within the terms of its engagement and in direct response to a scope of services. This report is strictly limited to the purpose and the facts and matters stated in it and does not apply directly or indirectly and must not be used for any other application, purpose, use or matter. In preparing the report, RPS may have relied upon information provided to it at the time by other parties. RPS accepts no responsibility as to the accuracy or completeness of information provided by those parties at the time of preparing the report. The report does not take into account any changes in information that may have occurred since the publication of the report. If the information relied upon is subsequently determined to be false, inaccurate or incomplete then it is possible that the observations and conclusions expressed in the report may have changed. RPS does not warrant the contents of this report and shall not assume any responsibility or liability for loss whatsoever to any third party caused by, related to or arising out of any use or reliance on the report howsoever. No part of this report, its attachments or appendices may be reproduced by any process without the written consent of RPS. All enquiries should be directed to RPS.

Prepared by:

Prepared for:

RPS Consulting Services Ltd

Vistry Group

Matthew Brown
Associate - Transport

20 Farringdon Street
London EC4A 4AB

T [REDACTED]
[REDACTED]

Contents

1	INTRODUCTION.....	1
2	EXISTING TRANSPORT CHARACTERISTICS	2
3	ACCESSIBILITY	11
4	PLANNING POLICY	18
5	DEVELOPMENT PROPOSAL.....	22
6	TRIP GENERATION AND DISTRIBUTION	26
7	TRAFFIC IMPACT	28
8	SUMMARY AND CONCLUSION	39

Appendices

- APPENDIX 1 – SITE CONTEXT PLAN
- APPENDIX 2 – COLLISION DATA
- APPENDIX 3 – TRAFFIC COUNT DATA
- APPENDIX 4 – PARKING BEAT SURVEY
- APPENDIX 5 – WALKING ISOCHRONES
- APPENDIX 6 – CYCLE ISOCHRONES
- APPENDIX 7 – BUS ROUTE PLAN
- APPENDIX 8 – MASTER PLAN
- APPENDIX 9 – SITE ACCESS DRAWING
- APPENDIX 10 – SWEEP PATH ANALYSIS
- APPENDIX 11 – RSA1 DESIGNER’S RESPONSE
- APPENDIX 12 – TRICS OUTPUT
- APPENDIX 13 – TRAFFIC FLOW DIAGRAMS
- APPENDIX 14 – LINSIG OUTPUTS
- APPENDIX 15 – JUNCTIONS 10 OUTPUTS

1 INTRODUCTION

- 1.1 RPS has been instructed by Vistry Group to undertake a Transport Assessment (TA) of a proposed residential site located on land to the south of Tollgate Road, Colney Heath, Hertfordshire. The site is within the district of St Albans City and District and Hertfordshire County Council (HCC) are the Highway Authority.
- 1.2 The development proposal is an Outline application for the demolition of the existing house and stables and the erection of up to 150 dwellings, including affordable and custom-build properties, together with all ancillary works (all matters reserved except access).
- 1.3 This TA describes the transport characteristics of the site, and the site's accessibility to facilities by sustainable modes of travel. It includes an assessment and analysis of the travel characteristics of the local St Albans MSOA 015 obtained from the 2011 Census. This information has been used to predict the future travel demands of the proposed development site and the likely impact on the local highway network.
- 1.4 This TA has been prepared in accordance with the National Planning Policy Framework – Planning Guidance for Transport Assessments and Transport Statements, with reference to Manual for Streets and Hertfordshire County Council 'Design Guide'. The scope of the TA was agreed with HCC following pre-application discussions.

Report Format

- **Section 2** describes the transport characteristics of the site and its location. It also includes the details of existing traffic flows, likely growth, and committed development traffic flows;
- **Section 3** describes the site's accessibility to facilities by sustainable modes of travel. This includes a description of walking and cycling facilities and access to public transport;
- **Section 4** provides a review of the relevant central government and local government land use and transport planning policies and guidance;
- **Section 5** provides details of the residential development including number of dwellings, access arrangements and parking;
- **Section 6** details the likely traffic generation associated with the proposed development and the distribution / assignment of that traffic onto the local highway network;
- **Section 7** considers the impact of the development on the road network; and
- **Section 8** provides a summary of the transport assessment and conclusions.

2 EXISTING TRANSPORT CHARACTERISTICS

Introduction

2.1 This section of the report describes the transport characteristics of the site and its location, including existing levels of car ownership in St Albans MSOA 015, residents' modes of travel to work, and a review of the local highway network including road traffic collisions. It also includes details of the existing traffic flows, likely traffic growth and committed development traffic flows.

Site Context

2.2 The site comprises 7.62ha of land located south of the existing residential area Colney Heath, south east of North Orbital A414 and west of A1.

2.3 The site location is detailed in **Figure 1** and a site context plan provided at **Appendix 1**.

Figure 1: Site Location

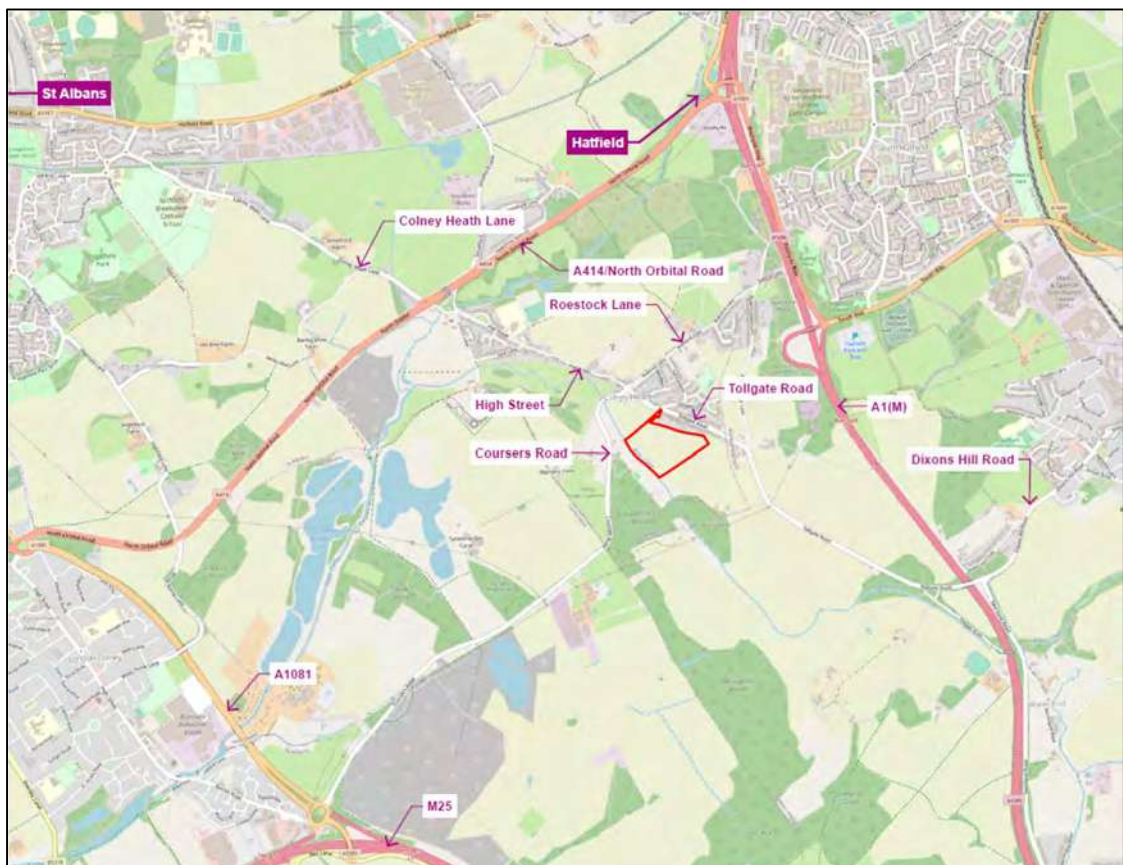

2.4 The site is bounded by existing residential dwellings and Tollgate Road to the north, the River Colne to the south. The site is bounded by farmland to the east and west.

Car Ownership

2.5 **Table 2.1** shows the household car ownership in the local area, as obtained from the 2011 Census data. The 2021 census data is not yet available, so this represents the most current complete data set.

Table 2.1: Household Car Ownership Levels in MSOA 015

Car Ownership	St Albans MSOA 015
None	10%
One	40%
Two	39%
Three	8%
Four or more	3%

2.6 From the 2011 Census data it is possible to ascertain the overall and average levels of car ownership of the MSOA based on the number of dwellings. For the St Albans MSOA 015 the data is as follows:

Table 2.2: Car Ownership Per Dwelling

	2011 Census Data
No. Households	2,282
Total Number of Cars Owned	3,543
Average Car Ownership Per Household	1.55

2.7 The existing levels of car ownership are slightly higher compared to the overall car ownership for St Albans City and District of 1.43 cars per household.

Travel to Work Characteristics

2.8 The 2011 Census 'Method of Travel to Work' (main mode) for the St Albans MSOA 015 identifies that 7 percent of residents walk or cycle, 20 percent of residents use public transport and 71 percent travel by car. **Figure 2** below details the modal splits for journeys to work for the St Albans MSOA 015 area.

Figure 2: Modal Split – Method of Travel to Work

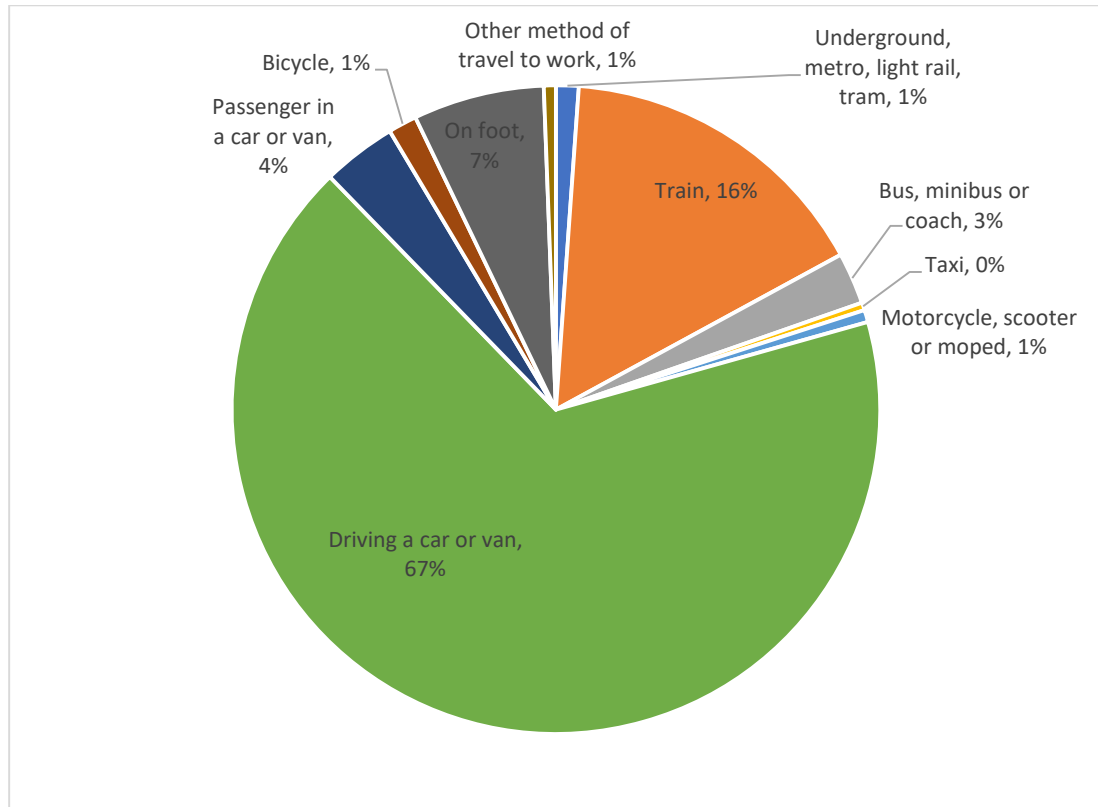

2.9 The above identifies that car is the main mode of travel for journeys to work. However, 20 percent of journeys are undertaken by public transport with 17 percent by train and 3 percent by bus. Therefore, the sites accessibility to bus stops and Welham Green railway station will be key for future residents. The existing use of active travel modes - walk and cycling - for journeys to work is relatively low with 7 percent walking and 1 percent cycling. However, it is likely that these modes form part of longer journeys such as to the station for a rail trip.

Existing Highway Network

- 2.10 The access to the site is via Tollgate Road, at the north of the site. Tollgate Road near to the site is urban in nature with frontage access to residential dwellings, and a 30mph speed limit.
- 2.11 Further east, Tollgate Road becomes more rural towards farmland, before connecting with Dixons Hill Road and a bridge over the A1(M) connecting Dixons Hill Road to Welham Green, where a main train station is located.
- 2.12 From Tollgate Road, there is a four-arm roundabout, connecting Tollgate Road to High Street, Roestock Lane and Coursers Road.
- 2.13 Whilst Roestock Lane becomes Bullens Green Lane, Coursers Road connects to London Colney, where a Sainsbury's, Marks and Spencer and Colney Fields Shopping Park are located.

High Street meets A414 / North Orbital Road, linking to Hatfield to the northeast, and London Colney to the southwest.

- 2.14 The junction connecting High Street and A414 / North Orbital Road also links Colney Heath Lane, towards St Albans.
- 2.15 To the east of the site is the A1(M), a two-way dual carriageway with a speed limit of 70mph, providing a link to the M25, which is to the south of the proposed site and is a main motorway with a speed limit of 70mph.

Road Traffic Collision Analysis

- 2.16 A review has been undertaken of road traffic collision data involving personal injury that have occurred on the road network in the vicinity of the site over a five-year period. Collision data has been obtained from HCC for the period 11th May 2017 to 11th May 2022. A copy of this data is provided at **Appendix 2** and the location of the junctions is shown on a plan provided at the beginning of **Appendix 3**.
- 2.17 The area covered includes the following junctions:
 - A414 North Orbital / High Street;
 - High Street, Rostock Lane, Tollgate Road, Courses Road;
 - Tollgate Road / Fellows Lane;
 - Dixons Hill Road / Swanland Road; and
 - A1000 Great North Road / Dixons Hill Road.
- 2.18 During this period a total of 12 injury collisions were recorded within the study area, three of which were serious and the rest were slight.

A414 North Orbital / High Street

- 2.19 A total of 1 slight accident was recorded at A414 North Orbital / High Street.
- 2.20 **Table 2.3** below provides the details of the collision.

Table 2.3: Collision Data – A414 North Orbital / High Street

Location	Date / Time	Severity	Conditions	Summary / Causation Factor
High Street Colney Heath, 20m South junction with A414 North Orbital Road	11 May 2017 17:30	Slight	Wet carriageway / Daylight	2 cars collided, causing one car to clip kerb and collide with lamp post. Causation Factor – using phone whilst driving and changing lanes, was not paying correct attention.

High Street, Rostock Lane, Tollgate Road, Courses Road;

- 2.21 There were no collisions at the roundabout junction linking High Street, Rostock Lane, Tollgate Road and Courses Road.

Tollgate Road / Fellows Lane;

- 2.22 A total of 1 serious accident was recorded at the Tollgate Road / Fellows Lane junction, involving 1 car and 1 motorbike.
- 2.23 **Table 2.4** below details the collision.

Table 2.4: Collision Data – A414 North Orbital / High Street

Location	Date / Time	Severity	Conditions	Summary / Causation Factor
Tollgate Road / Fellows Lane	15 Oct 2019 07:00	Serious	Wet carriageway / Daylight	Motorbike overtook stationary traffic and skidded and fell off bike. Causation Factor – poor turn, failed to look properly and lost control.

Dixons Hill Road / Swanland Road

- 2.24 There were 8 total incidences recorded on the Dixons Hill Road / Swanland Road junction, of which 7 were slight and 2 were serious.
- 2.25 Of the 2 serious accidents, 1 was due to failing to judge other drivers' path and speed, and the other was due to a car turning across the path of another car at the junction.
- 2.26 **Table 2.5** below details the collision.

Table 2.5: Collision Data Dixons Hill Road / Swanland Road

Location	Date / Time	Severity	Conditions	Summary / Causation Factor
Dixons Hill Road /Swanland Road	09 Jul 2019 08:23	Slight	Dry carriageway / Daylight	A car pulling out from Swanland Road hit and collided with another car on Dixons Hill Road. Causation Factor – failed to look properly and judge other cars movements
Dixons Hill Road /Swanland Road	31 Aug 2017 10:40	Serious	Dry carriageway / Daylight	Right turn collision at junction, LGV travelling across path of motorcyclist. Causation Factor – failed to judge other drivers' path and speed.

Location	Date / Time	Severity	Conditions	Summary / Causation Factor
Dixons Hill Road / Swanland Road	17 Sep 2019 16:45	Slight	Dry carriageway / Daylight	Right turn collision from Dixons Hill Road into Swanland Road between LGV and car which then resulted in a rear end shunt with a further 2 cars. Causation Factor – failed to judge another person’s path.
Dixons Hill Road / Swanland Road	23 June 2017 09:35	Serious	Dry carriageway / Daylight	Right turn collision into Swanland Road across path of another car. Causation Factor – car turning across the path of the other car at the junction.
Dixons Hill Road / Swanland Road	31 Mar 2018 11:06	Slight	Dry carriageway / Daylight	Right turn collision into Swanland Road, car travelling across the path of the second car. Causation Factor – failed to judge other persons speed and path.
Dixons Hill Road / Swanland Road	13 Apr 2021 17:00	Slight	Dry carriageway / Daylight	Right turn collision at junction, car turning across a LGV path, resulting in further collision with an additional car. Causation Factor – failed to judge persons path and not paying correct attention.
Dixons Hill Road / Swanland Road	24 Dec 2019 16:38	Slight	Wet carriageway / Darkness	Right turn collision at junction at Swanland Road. Causation Factor – failed to judge the persons speed and path.
Dixons Hill Road / Swanland Road	05 Dec 2019 17:25	Slight	Wet carriageway / Darkness	Right turn collision at junction. Causation Factor – carriageway was wet and person failed to judge the person’s path.
Dixons Hill Road / Swanland Road	04 Feb 2019 15:10	Slight	Dry carriageway / Daylight	Collision which led to rear end shunt. Causation Factor – failed to judge the person’s speed.

2.27 The above table indicates that there is an existing pattern of 7 collisions involving right turn movements occurring at the junction over the 5 year period. The proposed development will result in minimal traffic impact at the junction as detailed in section 7. The existing operation junction will be discussed with HCC highways to establish if it is an identified collision reduction site and if there are any mitigation measures proposed.

A1000 Great North Road / Dixons Hill Road

- 2.28 A total of 1 slight accident was recorded at the A1000 Great North Road / Dixons Hill Road, involving 1 car.
- 2.29 **Table 2.6** below details the collision.

Table 2.6: Collision Data – A1000 Great North Road / Dixons Hill Road

Location	Date / Time	Severity	Conditions	Summary / Causation Factor
A1000 Great North Road / Dixons Hill Road	20 Jul 2018 01:43	Slight	Dry carriageway / Darkness	A car was travelling at speed and lost control, colliding with a lamppost and bushes. Causation Factor – driver speeding.

Summary

- 2.30 The review of the collision data indicates a pattern of 7 collisions involving right turn movements occurring at the Dixons Hill Road / Swanland Road priority junction. The proposed development will result in minimal traffic impact at the junction as. The existing operation junction will be discussed with HCC highways to establish if it is an identified collision reduction site and if there are mitigation measures proposed.
- 2.31 The review of the remaining study network identifies no common patterns of collisions due to the characteristics of the local road network in the vicinity of the development site, rather carelessness on behalf of drivers, indicating that the local highway network has no pre-existing inherent deficiencies.

Existing Traffic Flows

- 2.32 As part of the TA scoping HCC agreed the following study area:
- A414 North Orbital / High Street – signalised junction;
 - High Street, Roestock Lane, Tollgate Road, Courses Road – roundabout junction;
 - Tollgate Road / Fellowes Lane – priority junction;
 - Dixons Hill Road / Swanland Road – priority junction; and
 - A1000 Great North Road / Dixons Hill Road – roundabout junction.
- 2.33 Traffic surveys were undertaken at the above junctions on behalf of RPS by 360 TSL on Tuesday 29th March 2022. The turning count data was collected in 15-minute intervals for the morning and afternoon weekday peak periods (07:00-10:00 and 16:00-19:00).
- 2.34 The traffic survey identified the following peak hours:
- The morning peak hour 08:00-09:00; and
 - The evening peak hour 17:00-18:00.

- 2.35 An Automated Traffic Count (ATC) including vehicle speeds has been undertaken on the Tollgate Road in the vicinity of the proposed access arrangement. The results of the ATC have been used to aid the design of the site access arrangement.
- 2.36 The average 5 weekday and 7-day week morning and evening peak hours and daily traffic flows on Tollgate Road are summarised in **Table 2.7** below.

Table 2.7: Existing Traffic Movements – Church Road

Time	Eastbound		Westbound		Total	
	5 Weekday Average Flows	7-Day Week Flows	5 Weekday Average Flows	7-Day Week Flows	5 Weekday Average Flows	7-Day Week Flows
08:00-09:00 AM Peak	270	218	391	313	661	531
17:00-18:00 PM Peak	267	249	230	209	497	459
Daily	3094	2986	3184	3014	6278	6000

- 2.37 The results of the traffic survey indicate that Tollgate Road is relatively lightly trafficked in the morning and evening peak hours. Tollgate Road is a 2-lane single carriageway and has a design capacity in the peak direction of approximately 850 vehicles per hour. The peak directional flow is westbound in the morning peak hour of 391 vehicle movements. Tollgate Road is currently operating at around 46 percent of its peak hour lane capacity, which means that free flow conditions will be normal.
- 2.38 A copy of the 2022 traffic count data is contained in **Appendix 3**.

Existing Parking Beat Survey – Tollgate Road

- 2.39 On site observations identified that on-street parking occurs on the northern side of Tollgate Road to the east of the junction with Fellowes Lane.
- 2.40 Parking beat surveys were undertaken on Tollgate Road on behalf of RPS by 360 TSL on Tuesday 29th March 2022 to provide a snap shot of parking demand between 12:00-13:00 and 20:00-21:00. A copy of the full parking beat survey is provided at **Appendix 4**.
- 2.41 The size of a car parking space has been based on 5m and the study area comprises the section of Tollgate Road to the east of Fellowes Lane to the boundary of the existing residential dwellings, as show in **Figure 3**.

Figure 3: Parking Beat Study Area

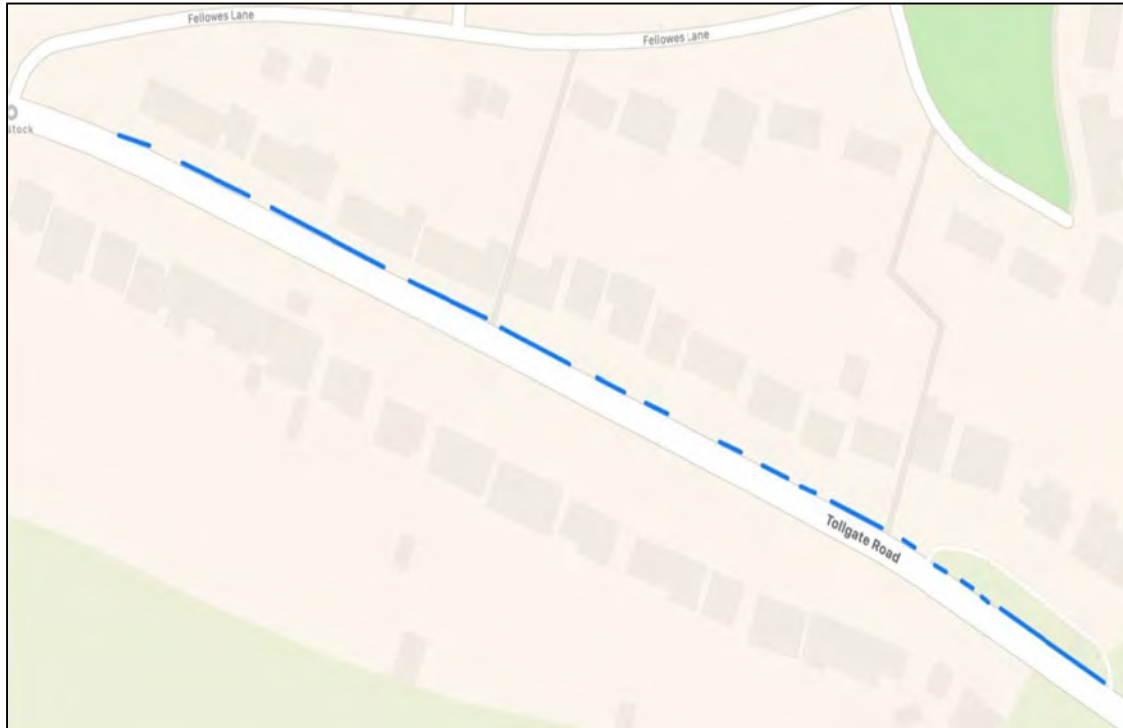

2.42 The blue line detailed on the above plan details the unrestricted sections of kerb on the northern side of Tollgate Road, that on-street parking can occur. The longest section of kerb available for parking is circa 30m and could accommodate up to 6 cars.

2.43 The results of the parking beat street survey are summarised in **Table 2.8** below.

Table 2.8: Tuesday 29th March 2022 – Parking Beat Stress Survey – Northern Side of Tollgate Road

Time Period	Parking Capacity	Spaces Occupied	Spare Spaces	% Occupancy
12:15	34	8	26	24%
20:10	34	14	20	41%

2.44 The above table identifies a maximum parking stress of 14 vehicles (41% occupancy) occurred in the evening at a time when most vehicles would be parked for the night. The parking survey identifies that there is significant spare on-street parking capacity on the northern side of Tollgate Road to the east of the junction with Fellowes Lane. The gaps in the existing on street parking will provide space for eastbound vehicles to pull in and give way to oncoming vehicles. The impact of the development on the existing operation of Tollgate Road to the east of site access is detailed at Section 7.

3 ACCESSIBILITY

Introduction

3.1 This section of the report considers the sustainability of the site in terms of opportunities for travel by walking, cycling and public transport.

Walking Accessibility

3.2 This section details the site's accessibility on foot and looks at facilities and connections in the local area. It goes on to consider the available footway and crossing facilities in the area and interventions that will be deliverable by the development.

Local Facilities Within Walking Distance

3.3 **Figure 4** demonstrates the walking time from the site within the local area, based on an assumed walking speed of 80m per minute (4.8kph), up to a maximum distance of 2km from the centre of the site. **Appendix 5** shows the full-size indicative walking isochrones from the site.

Figure 4: Pedestrian Isochrone and Local Facilities

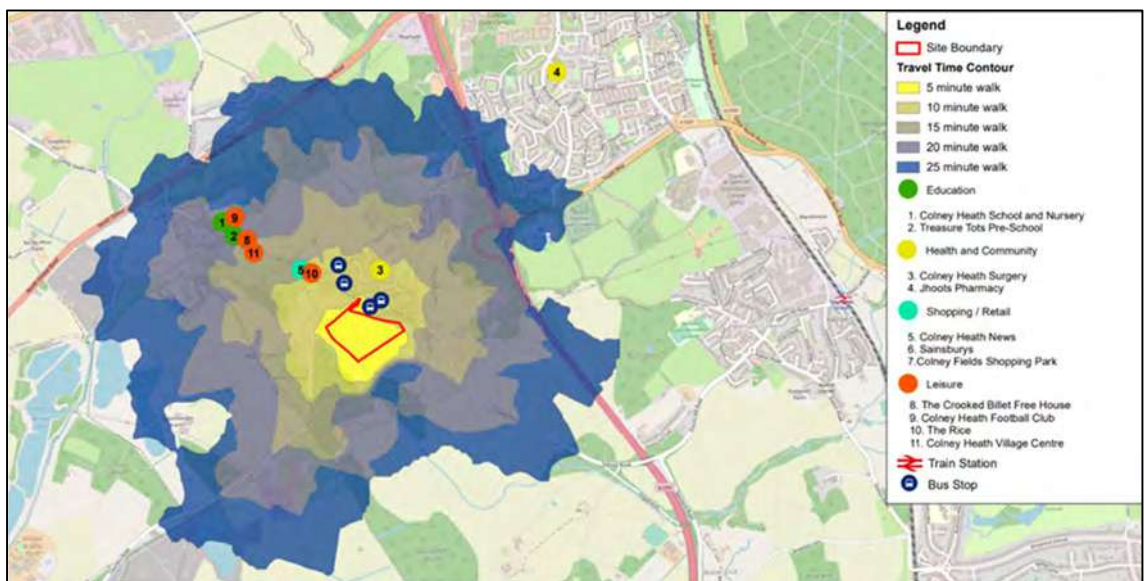

3.4 **Table 3.1** below identifies the walking distance and time to local facilities measured from the centre of the site. This is not an exhaustive list, but rather an example of distances and travel times to local facilities.

Table 3.1: Walking Journey Distance to Local Facilities

Facility	Approx. Distance (M)	Approx. Walking Time (Mins)
Education		
Colney Heath School and Nursery	1100	14
Treasure Tots Pre-School	950	12
Link Academy	3800	48
Nicholas Breakspear	3200	40
University of Hertfordshire	3700	46
Health and Community		
Jhoots Pharmacy	4600	58
Shopping / Retail		
Colney Heath News	600	8
Sainsburys	4400	55
Colney Field Shopping Park	4400	55
Leisure Facilities		
The Crooked Billet Free House	1000	13
Colney Heath Football Club	1100	14
The Rice	580	7
Colney Heath Village Centre	950	12
Public Transport		
Welham Green Train Station	3800	48
Roestock Lane Bus Stop (Tollgate Road)	390	5
Roestock Lane Bus Stop (Roestock Lane)	530	7
Fellowes Lane Bus Stop SE (Tollgate Road)	350	4
Fellowes Lane Bus Stop NW (Tollgate Road)	300	4

3.5 Walking trips are predominately short trips of up to 2km. The standard speed used for assessing walking accessibility is 80 metres per minute, giving a 25-minute walking time for 2km trip. This is an average speed for assessment purposes, while actual trips will vary depending on the person walking, the purpose of the trips, the gradient experienced and any obstacles that may be encountered (crossing points for roads / etc.). Walking trips are important as they provide

- connectivity between other trip types, such as longer bus and train trips, or between parking areas and the destinations for car trips, as well there being trips that are purely served by walking.
- 3.6 The topography of Colney Heath (almost flat) is ideal for walking and for mobility impaired accessibility.
 - 3.7 The existing buses route along Tollgate Road and Roestock Lane are within a 5-7-minute walk of the site. This is regarded as a reasonable access time to public transport.
 - 3.8 Welham Green Train is circa 3.7km walk distance from the site and within a 48-minute walk of most of the site. It is therefore, considered unlikely that a significant proportion of future residents would choose to walk to the station via this route. Cycle or bus access to the station is likely to be preferable as set out below.
 - 3.9 The site is relatively large, so walking distances will depend on which part of the site is the origin for a trip, however, Colney Heath News newsagents is located 10–15 minute walk away of the site. Therefore, future residents will have access to this, along with leisure amenities such as a takeaway, which is within a 10-minute walk, and Village Centre a 15 minute walk away.
 - 3.10 HCC School Travel Plans highlight the importance of promoting sustainable travel to school as a key principle of Sustainable Modes of Travel Strategy (SMoTS). The site is located within 10 minutes' walk of Colney Heath School and Nursery and Treasure Tots Pre School, therefore allowing for walking rather than driving to school. Secondary schools of Link Academy and Nicholas Breakspear are within a 46-minute and 38-minute walk respectively, and the University of Hertfordshire can also be accessed within a circa 38-minute walk.

Walking Routes

- 3.11 This section of the strategy considers the site's accessibility by cycle and looks at facilities and connections in the local area. It goes on to consider the available cycling facilities in the area along with potential interventions that may be deliverable with investment from the development.

Cycle Accessibility

- 3.12 This section considers the site's accessibility by cycle and looks at facilities and connections in the local area. It then considers the available cycling facilities in the area along with potential interventions with investment from the development.
- 3.13 Recent growth of cycling across the UK, following programmes of investment, have illustrated that there is significant potential for change in travel behaviour and that more people cycle for everyday journeys where acceptable conditions are provided. Two out of every three personal trips are less than five miles in length – an achievable distance to cycle for most people, with many shorter journeys also suitable for walking. For schoolchildren the opportunities are even greater: three quarters of children live within a 15-minute cycle ride of a secondary school, while more than 90% live within a 15-minute walk of a primary school. The development site is within easy cycle distance of local secondary and primary schools. Therefore, cycling has significant potential to replace the car for short journeys to local facilities, education, and commuting.

Local Facilities Within Cycle Distance

- 3.14 **Figure 5** demonstrates the cycling time from the site within the local area, based on an average cycling speed of 200 metres per minute (12kph), up to a maximum distance of 5km from the centre of the site. **Appendix 6** shows the full-size indicative cycle isochrones from the site.

Figure 5: Cycle Isochrones

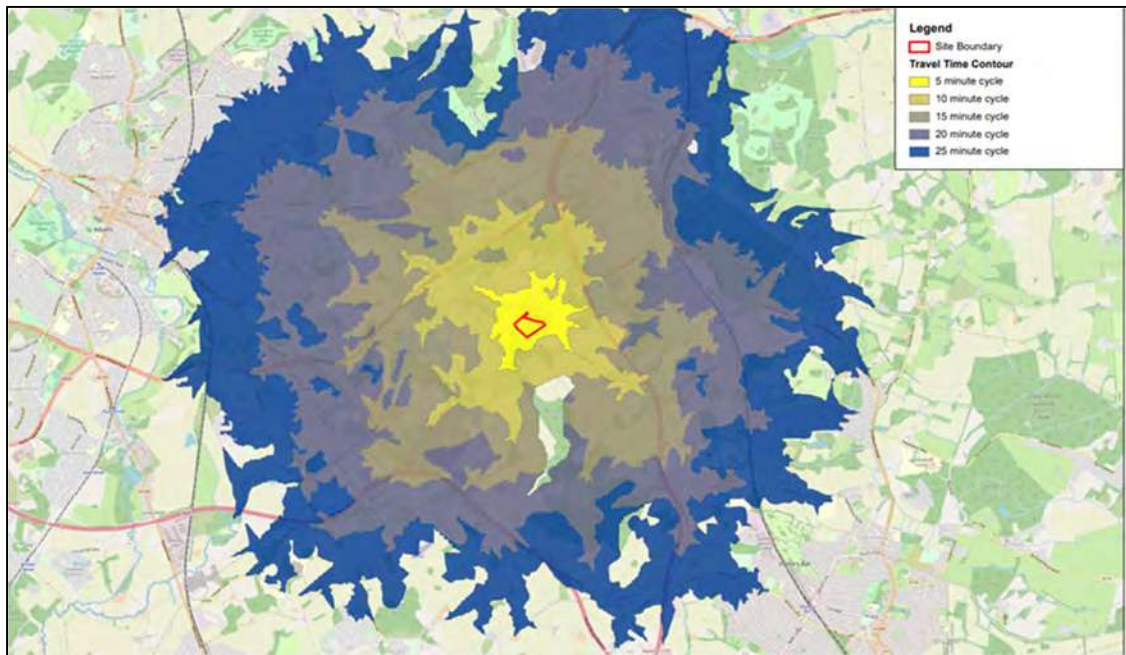

- 3.15 **Table 3.2** below identifies the cycle distance and time to local facilities measured from the centre of the site. This is not an exhaustive list, but rather an example of distances and travel times to local facilities.

Table 3.2: Cycling Journey Distance to Local Facilities

Facility	Approx. Distance (M)	Approx. Cycle Time (Mins)
Education		
Colney Heath School and Nursery	1100	6
Treasure Tots Pre-School	950	5
Link Academy	3800	19
Nicholas Breakspear	3200	16
University of Hertfordshire	3700	19
Health and Community		
Jhoots Pharmacy	4600	23
Shopping / Retail		
Colney Heath News	600	3
Sainsburys	4400	22
Colney Field Shopping Park	4400	22
Leisure Facilities		
The Crooked Billet Free House	1000	5
Colney Heath Football Club	1100	6
The Rice	580	3
Colney Heath Village Centre	950	5
Public Transport		
Welham Green Train Station	3800	19
Roestock Lane Bus Stop (Tollgate Road)	390	2
Roestock Lane Bus Stop (Roestock Lane)	530	3
Fellowes Lane Bus Stop SE (Tollgate Road)	350	2
Fellowes Lane Bus Stop NW (Tollgate Road)	300	2

- 3.16 Due to its topography (almost flat) Colney Heath is ideal for cycling, with many nearby local residential roads lightly trafficked and suitable to accommodate cycling on road.

- 3.17 The cycle isochrones from the development site identify that nearby town of Hatfield and villages of London Colney and Welham Green are accessible within a 25-minute cycle ride. Welham Green train station is also within a circa 20-minute cycle ride to the east of the development site.

Existing Cycle Facilities

- 3.18 Tollgate Road itself is a route suggested by local cyclists, as is High Street and Roestock Lane leading off from the four-arm roundabout. The North Orbital Road, northeast towards Hatfield is a cycle route via the

Public Transport

- 3.19 This section considers the existing availability of public transport in the vicinity of the site and reviews connections to local and wider destinations by rail and bus.

Welham Green Railway Station

- 3.20 Welham Green railway station located circa 3.7km to the east of the site and accessible via Tollgate Road / Dixons Hill Road. The station is located within 18 ½ minutes cycle ride of the site.
- 3.21 Welham Green train station is on the East Coast Main Line, serving the Welham Green. The station is 18 miles from London Moorgate and located between Hatfield to the north and Brookmans Park to the south. The station and all trains serving it are currently operated by Govia Thameslink Railway.
- 3.22 The typical off-peak service frequency is:
- 2 trains per hour (tph) northbound towards Welwyn Garden City, of which all call at all stations; and
 - 2 tph southbound towards Moorgate, of which all call at all stations.
- 3.23 The station is within a 20-minute cycle of the site and there is cycle storage located next to the booking office.

Bus

The nearest bus stops are located to the south east of the proposed site access on Tollgate Road (Fellows Lane). These bus stops are accessible via the footway provision on either side of Tollgate Road. The bus stops are located within an approximate 400m (4-minute short walk) from the centre of the site.

Bus stops are also located on Hall Gardens within approximately 390m (5-minute walk) of the site and provided access to bus service 200. Bus stops located on Roestock Lane are within approximately 480m of the site and provide access to the 305 service that runs between Sandridge and Potters Bar.

Table 3.3 below summarises the bus routes and frequency of service. A bus route plan is provided at **Appendix 7**.

Table 3.3: Bus Route and Frequency – High Street – Two Brewers

Service / Bus Company / Bus Stop	Route	Average Frequency (Minutes)		
		Mon-Fri	Saturday	Sunday
200 – Chiltern Automotive – Hall Gardens	London Colney – Essendon Mill	Only runs Monday 10:21 and 12:41	No service	No service
230 – Chiltern Automotive - Fellowes Lane	St Albans – Welwyn Garden City	Only runs Wednesday 11:13 and 14:23	No service	No service
305 – Metro Line Travel / Fellowes Lane	Colney Heath – New Greens	2 services 07:32 and 16:45	No service	No service
305 – Metro Line Travel – Roestock Lane	Sandridge – Potters Bar	3 services 10:06, 12:31 and 14:53	4 services 10:06, 12:31, 14:53 and 16:16	No service
312 – Chiltern Automotive – Fellowes Lane	Hatfield – Bell Bar	Only runs Wednesday 10:00 and 12:26	No service	No service
355 – Sullivan Buses – Fellowes Lane	Nicholas Breakspear School – Carterhatch Lane	HCC schooldays only 08:05 and 15:27	No service	No service

- 3.24 The site is within easy walking distance of bus stops that provide access to all 5 bus services that currently operate in Colney Heath.
- 3.25 The existing bus services in Colney Heath operate at limited frequencies and days of the week but may be used by future residents for some journeys to local destinations. It should be noted that Routes 230 and 312 provide connections to Welham Green train station on a Wednesday. In addition, bus route 355 will provide a useful connection to the Nicholas Breakspear secondary school from the site.
- 3.26 To reflect the limitations of the existing bus services the development will provide a contribution towards sustainable transport improvements and this is set out in Section 5.

Summary

- 3.27 The walking accessibility of the site is deemed to be good, with day-to-day facilities available within reasonable walking distance. The proximity of the site to the primary school also means education trips, walking will be a realistic alternative to travel by private car.
- 3.28 The development site is accessible within a 25-minute cycle ride of the nearby town and Hatfield and villages of London Colney and Welham Green. Welham Green train station is also within a circa 20-minute cycle ride to the east of the development site.
- 3.29 The existing bus services in Colney Heath operate at limited frequencies and days of the week but may be used by future residents for some journeys to local destinations.
- 3.30 In terms of sustainability, the location of the site is conducive to providing future residents with a realistic choice to the private car for many day-to-day journeys.

4 PLANNING POLICY

Introduction

4.1 This section of the report evaluates the development proposal against the appropriate national and local land use and transport planning policies:

- National Planning Policy Framework (NPPF); and
- Planning Practice Guidance.

National Planning Policy Framework (NPPF, 2021)

4.2 The current National Planning Policy Framework (NPPF), updated in July 2021, replaces the previous Framework published in March 2012 as revised in July 2018 and updated in February 2019.

4.3 The NPPF sets out several transport objectives designed to facilitate sustainable development and contribute to a wider sustainability by giving people a wider choice about how they travel, in particular Section 9 'Promoting Sustainable Transport'.

4.4 Paragraph 110 states:

“In assessing sites that may be allocated for development in plans, or specific applications for development, it should be ensured that:

- **appropriate opportunities to promote sustainable transport modes can be – or have been – taken up, given the type of development and its location;**
- **safe and suitable access to the site can be achieved for all users;**
- **the design of streets, parking areas, other transport elements and the content of associated standards reflects current national guidance, including the National Design Guide and the National Model Design Code; and**
- **any significant impacts from the development on the transport network (in terms of capacity and congestion), or on highway safety, can be cost effectively mitigated to an acceptable degree.”**

4.5 Paragraph 111 continues that:

“Development should only be prevented or refused on highways grounds if there would be an unacceptable impact on highway safety, or the residual cumulative impacts on the road network would be severe.”

4.6 In terms of planning applications NPPF states at paragraph 112(a) that development should:

“Give priority first to pedestrian and cycle movements, both within the scheme and with neighbouring areas, and second – so far as possible – to facilitating access to high quality public transport, with layouts that maximise the catchment area for bus or other public transport services, and appropriate facilities that encourage public transport use.”

4.7 Paragraph 113 covers the need for Travel Plans and Transport Statements / Assessments for all developments which generate significant amounts of movement.

4.8 Regarding parking, Paragraph 107 of the NPPF states that:

“In setting local parking standards for residential and non-residential development, policies should take into account:

- a. The accessibility of the development;**
- b. The type, mix and use of development;**
- c. The availability of and opportunities for Public Transport;**
- d. Local car ownership levels; and**
- e. The need to ensure an adequate provision of spaces for charging plug-in and other ultra-low emission vehicles.”**

4.9 Paragraph 108 states that:

“Maximum parking standards for residential and non-residential development should only be set where there is a clear and compelling justification that they are necessary for managing the local road network, or for optimising the density of development in city and town centres and other locations that are well served by public transport (in accordance with Chapter 11 of this Framework)...”

Planning Practice Guidance (NPPG) ‘Travel Plans, Transport Assessments and Statements in Decision-Taking’ (March 2014)

4.10 This Guidance provides advice on when Travel Plans, Transport Assessments and Statements are required, and what they should contain. The Guidance is regularly updated, with the last update being 28 July 2017.

4.11 Transport Assessments and Statements are ways of assessing the potential transport impacts of developments, and they may propose mitigation measures to promote sustainable developments. Transport Assessments are thorough assessments of the transport implications of development, and Transport Statements are a ‘lighter-touch’ evaluation to be used where this would be more proportionate to the potential impact of the development.

4.12 Transport Assessments and Statements can be used to establish whether the residual transport impacts of a proposed development are likely to be “severe”, which may be a reason for refusal, in accordance with NPPF.

4.13 Travel Plans are long-term management strategies for integrating proposals for sustainable travel into the planning process. They are based on evidence of the anticipated transport impacts of development and set measures to promote and encourage sustainable travel.

Hertfordshire Local Transport Plan (2018)

4.14 Since 2014 Hertfordshire County Council (HCC) have been working on a new Transport Vision for Hertfordshire, which has resulted in the adoption of the new Local Transport Plan (LTP4). The

LTP4 builds on the Local Transport Plan 3 which was published in 2011 to cover the period to 2031. This LTP sets out how transport can help deliver a positive future vision for Hertfordshire by having a major input into wider policies such as economic growth, meeting housing needs, improving public health and reducing environmental damage whilst also providing for safe and efficient travel. The plan also considers how future planning decisions and emerging technology might affect the way that transport needs to be provided in the longer term.

4.15 The Hertfordshire Vision states: “We want Hertfordshire to be a county where people have the opportunity to live healthy, fulfilling lives in thriving, prosperous communities.” To achieve this vision, the LTP aims to deliver nine transport objectives which contribute strongly to the Place, Prosperity and People elements of the vision. The objectives are:

- **“Improve access to international gateways and regional centres outside Hertfordshire;**
- **Enhance connectivity between urban centres in Hertfordshire;**
- **Improve accessibility between employers and their labour markets;**
- **Enhance journey reliability and network resilience across Hertfordshire;**
- **Enhance the quality and vitality of town centres;**
- **Preserve the character and quality of the Hertfordshire environment;**
- **Reduce carbon emissions;**
- **Make journeys and their impact safer and healthier; and**
- **Improve access and enable participation in everyday life through transport.”**

4.16 Cutting across the objectives are four principles guiding activity, which feature common to activities to manage and improve the transport system. The principles are:

- **“Integration of land use and transport planning**
- **Application and adoption of technology**
- **Cost effective delivery and maintenance**
- **Modal shift and encouraging active travel.”**

St Albans City and District Council Local Plan (2020-2038)

4.17 St Albans are preparing a new Local Plan (2020-2038) which will replace the District Local Plan Review 1994. The new Local Plan highlights the delivery of new infrastructure for existing and new developments.

4.18 A Local Cycling and Walking Infrastructure Plan is being developed with HCC to further establish cycling and walking routes in the area.

4.19 The Sustainability Appraisal Scoping report of the Local Plan 2020-2038 highlights the need to:

- **“Promote sustainable modes of transport, particularly cycling and walking**
- **Reduce inequalities and improve safe access to services**
- **Provide a wide range of good quality housing to meet the diverse needs of the community.”**

St Albans City and District Council – Revised Parking Policies and Standards January 2002

- 4.20 The St Albans City and District Council states that car parking for residential development should be provided with parking standards contained within Policy 40 of the Design Advice Leaflet No.1. These standards are replicated in **Table 4.1** below.

Table 4.1: Parking Standards

Dwelling Size	Number of allocated spaces	Unallocated	Total
1 Bedroom	0	1.5	1.5
	1	0.5	1.5
	0	2	2
2 Bedrooms	1	1	2
	2	0.5	2.5
3 Bedrooms	2	0.5	2.5
4 bedrooms or more	3	0.5	3.5

- 4.21 The allocated spaces are off street spaces provided to individual dwellings. The unallocated spaces are not allocated to any dwelling but available for public use including visitors. For 1- and 2-bedroom dwellings applicants have a choice if whether parking provision will be allocated to individual dwellings.
- 4.22 In terms of cycle parking the parking standards require 1 long term spaces per unit if no garage or shed is provided within the curtilage.

Summary

- 4.23 The key transportation policy is to ensure that new developments are in locations which are or can be made sustainable.
- 4.24 In this respect new developments should be in accessible location, which are conducive by travel by walking, cycling or using public transport, for every day trips associated with employment, education and leisure purposes.
- 4.25 In terms of sustainability the development site, its location benefits from good accessibility to existing bus services and reasonable access to rail services. Local facilities including shops and schools are all accessible by walking and cycling. The site will therefore provide residents with realistic sustainable travel choices to the private car for some journeys.
- 4.26 The proposed development provides a safe means of access, and parking in accordance with adopted standards. A commitment to a Travel Plan and Travel Information Packs will assist residents in adopting sustainable travel practices.
- 4.27 As such, the proposed development is considered to accord to relevant national and local land use and transport policy.

5 DEVELOPMENT PROPOSAL

Development Proposal

- 5.1 The development proposal is an Outline application for the demolition of the existing house and stables and the erection of up to 150 dwellings, including affordable and custom-build properties, together with all ancillary works (all matters reserved except access).
- 5.2 A full description of the proposed residential development is contained in the planning application's supporting Planning Statement and accompanying plans. The following description is pertinent in transport terms.
- 5.3 The masterplans for the development proposal are detailed in drawings provided at **Appendix 8**.

Vehicular Access Arrangement

- 5.4 It is proposed that the development is served by a single access via Tollgate Road at the north west corner of the site.
- 5.5 The access requires the demolition of property No. 42 Tollgate Road to form a priority junction on the southern side of Tollgate Road. The access has been provided with a 6m carriageway width and 2m footways on both sides that tie into the existing footway provision on the southern side of Tollgate Road. The kerb radii are provided at 6m to accommodate the swept path of the largest design vehicle (refuse collection vehicle).
- 5.6 The site access is located opposite the junction with Fellowes Lane. It is proposed that the both the site access and Fellowes Lane junction are traffic calmed by the provision of a raised table. In addition, a new section of footway is proposed on the north side of Tollgate Road to the west of junction with Fellowes Lane. This will provide a continuous east / west footway provision on the northern side of Tollgate Road adjacent to the site access.
- 5.7 The priority junction design is detailed in **Figure 6** below and the full design provided at **Appendix 9**.

Figure 6: Site Access Arrangement

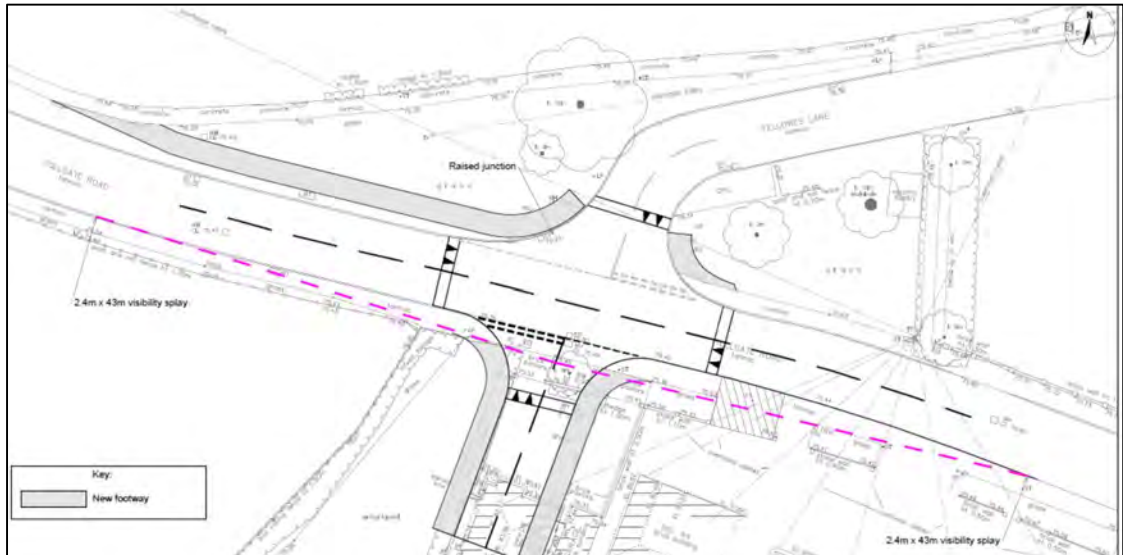

- 5.8 To check that the driver visibility at the proposed access accords with the relevant design standards an ATC (Automated Traffic Counter) was placed on Tollgate Road in the vicinity of the proposed access to establish the 85th percentile speeds in both directions. The results of the speed survey are as follows:
- Eastbound - 38.2mph; and
 - Westbound - 36.2mph.
- 5.9 The recorded 85th percentile speeds are more than the 30mph speed limit that operates on Tollgate Road. The provision of a raised table at the proposed site access and junction with Fellowes Lane will provide a traffic calming feature to reduce vehicle speeds on Tollgate Road and provided a more pedestrian and cycle friendly environment.
- 5.10 To reflect the traffic calming effect of the proposed raised table a visibility splay of 2.4m x 43m is shown at the proposed site access and commensurate with the 30mph speed limit. The splay is robust as the traffic calming will reduce speeds below 30mph.
- 5.11 The visibility splays at the proposed access arrangement are indicated in the site access drawing attached at **Appendix 9**.

Emergency Vehicle Access

- 5.12 The development proposal is anticipated to accommodate up to 150 dwellings. The provision of a second access for emergency use is not considered necessary as it is stated within MfS:

“Authorities have often argued that the larger the site, the more likely it is that a single access could be blocked for whatever reason. The fire service adopts a less numbers driven approach and considers each application based on a risk assessment for the site and response time requirements.”

Pedestrian / Cycle Access

- 5.13 Pedestrian and cycle access will be via the proposed vehicular access arrangement. The vehicular access will provide cyclists with access to Tollgate Road and 2m footways will be provided on both sides of the access and connect to the existing southern Tollgate Road footway.

Servicing

The proposed access has been designed to accommodate refuse vehicles and fire tenders as shown by the swept path analysis attached at **Appendix 10**.

Parking Provision

- 5.14 The vehicle and cycle parking provision on site will accord with the standards contained within St Albans City and District Council – Revised Parking Policies and Standards January 2002

Electric Vehicle Charging Provision

- 5.15 It is proposed that each dwelling that has a designated parking space will be provided with an electric vehicle charging point.

Stage 1 Road Safety Audit

- 5.16 As part of this application a Stage 1 Road Safety Audit (RSA1) has been undertaken for the proposed highway access arrangements and changes to the highway layout. The RSA1 was undertaken by Taylor Bowie Ltd on 19 May 2022.
- 5.17 The RSA 1 raises 5 problems for the design team to consider. Following a review of the RSA1 the design team considers that the problems can be easily covered at the detailed design stage post planning.
- 5.18 Details of the RSA 1 Audit and the RSA1 Designers Response are included in **Appendix 11**.

Sustainable Transport Contribution

- 5.19 The existing bus services in Colney Heath operate at limited frequencies and days of the week.
- 5.20 The development provides the opportunity to improve the existing bus services via planning obligations towards sustainable transport improvements.
- 5.21 The contribution towards sustainable transport improvements will be in accordance with Hertfordshire County Councils Planning Obligations Guidance – Toolkit for Hertfordshire – January 2008. The Toolkit details the standard sustainable transport charges for residential developments in Table 1. Table 1 of the guidance is replicated below.

Table 5.1: Sustainable Transport Second Strand Approach: Standard Charges for Residential Developments:

Location	Second Strand Charge per dwelling (£)			
	Number of Bedrooms			
	1	2	3	4+
Town Centre Zones 1&2	£375	£500	£750	£1,000
Elsewhere Zones 3&4	£625	£750	£1,125	£1,500

- 5.22 The development site is not located in a town centre and the level of charge reflects the less sustainable location. Based on an average of 3 bedrooms the 150 dwelling development could attract a sustainable transport contribution of £168,750. However, the guidance states that the contribution will need to be index linked by SPONS from July 2006 (the point of time at which the above figures were calculated). Based on an initial review of the SPONS manual the level of contribution would need to be increased by circa 50% (£253,125).
- 5.23 The actual level of the sustainable transport contribution will need to be discussed and agreed with HCC as part of the planning process. The contribution will be passed to the planning or the highway authority to improve sustainable transport in the local Colney Heath area.

Residential Framework Travel Plan

- 5.24 As can be seen from the accessibility review in Section 3, the site is within an easy walk and cycle distance of many local facilities and public transport. Therefore, the location of the development will provide residents with the opportunity to travel by alternative modes to the private car for some journeys.
- 5.25 To further encourage the use of alternative modes of transport to the private car a Framework Residential Travel Plan has been produced as a separate document.
- 5.26 The Framework Travel Plan aims to:
- Encourage the use of sustainable modes of transport, such as walking, cycling and using public transport;
 - Reduce unnecessary travel; and
 - Encourage the use of sustainable travel by improving facilities and providing information.
- 5.27 The information within the Residential Travel Plan will help introduce residents to alternative modes and enable them to consider the trips to be made and the modes of transport they can use. It is intended that the Residential Travel Plan will encourage a change in perceptions and attitudes and therefore the desired change in travel behaviour, i.e., less unnecessary car use.

6 TRIP GENERATION AND DISTRIBUTION

Introduction

6.1 This section considers the likely traffic generation of the development of 150 residential dwellings. In determining the predicted trip generation for the site, the TRICS database has been used, and to ascertain the trip distribution / assignment for the residential development, travel to work data from the 2011 Census has been used.

Residential Trip Generation

6.2 The residential trip generation for up to 150 dwellings has been based on the TRICS database (multi-modal) for other similar developments. To ensure that the sites selected are comparable to the proposed residential development the following selection parameters are proposed:

- a. Land use: Residential;
- b. Category: Houses Privately Owned;
- c. Regions and Areas: England (excluding Greater London);
- d. Number of Dwellings (Actual Available Range): 100– 200 dwellings;
- e. Location: Edge of Town, Suburban Area and Neighbourhood Area;
- f. Car ownership within 5 miles: 1.1 to 1.5; and
- g. Date Range: 01 January 2014 to 08 November 2021.

6.3 The selection based upon private housing sites will represent a robust scenario in terms of traffic generation for the site, as affordable housing, private flats and rented accommodation generally all have lower trip rates. A copy of the TRICS output is provided at **Appendix 12** of this report.

6.4 **Table 6.1** summaries the morning and evening peak period vehicle trip rates obtained from the TRICS database and applies this to the proposed 150 dwellings to establish the respective trip generation for the peak periods.

Table 6.1: Residential Trip Rates and Trips for 150 Units

Trip Rate / Trips	AM Peak (08:00 - 09:00)			PM Peak (17:00 - 18:00)		
	Arrivals	Departures	Total	Arrivals	Departures	Total
Vehicular Trip Rate (Private Houses)	0.133	0.307	0.440	0.296	0.171	0.467
150 residential dwellings	20	46	66	44	26	70

6.5 The proposed residential development of 150 residential units has the potential to result in 66 total vehicle trips in the morning peak hour and 70 total vehicle trips in the evening peak hour.

Traffic Distribution

Residential Traffic Distribution

6.6 The distribution of the residential trips has been reviewed based on the 2011 Census database, which provides details of where residents within St Albans MSOA area 015 currently work. This will provide an indication of distribution for the primary trip purpose.

6.7 The residential traffic based on the Census journey to work data results in the following distribution:

Westbound

- 68% westbound Tollgate Road of which:
 - 29% routes via Coursers Road; and
 - 39% routes via N Orbital Road.

Eastbound

- 32% eastbound Tollgate Road of which:
 - 11% routes via Swanland Road; and
 - 21% routes via Great North Road.

6.8 The base and proposed traffic flow diagrams are provided at **Appendix 13**.

7 TRAFFIC IMPACT

7.1 Within section 6 the predicted level of trips (and their distribution / assignment) which the proposed development is likely to generate is calculated. This section of the TA considers the transport impact on the proposed development at key junctions on the local road network within the vicinity of the site.

Assessment Parameters

Study Area

7.2 In line with scoping discussions, the impact of the proposed residential development will be tested at the following local junctions:

- A414 North Orbital / High Street – signalised junction;
- High Street, Roestock Lane, Tollgate Road, Courses Road – roundabout junction;
- Tollgate Road / Fellowes Lane – priority junction;
- Dixons Hill Road / Swanland Road – priority junction; and
- A1000 Great North Road / Dixons Hill Road – roundabout junction.

7.3 In addition, the impact of the proposed residential development on Tollgate Road in relation to the existing on street parking to the east of Fellowes Lane is also determined. The location of the junctions is shown on a plan provided at the beginning of **Appendix 3**.

Future Year Assessment and Traffic Growth

7.4 The now rescinded DfT Guidance on Transport Assessments indicated that the future assessment year should normally be five years after the date of the planning application. However, the current National Planning Policy Framework – Planning Guidance for Transport Assessments and Transport Statements simply states that the future year assessment should be agreed with the Local Highway Authority.

7.5 It has been agreed as part of the scoping discussions that the impact on the local highway will be five years after the planning application 2027. Therefore, the DfT traffic growth methodology has been applied to the 2021 observed flow using forecasts from TEMPRO Version 7.2 and the NTM for St Albans MSOA area 015. The proposed growth rates are as follows:

- 2022 – 2027 Morning Peak = 1.0157; and
- 2022 – 2027 Evening Peak = 1.0160.

7.6 It should be noted that TEMPRO includes growth in housing as part of its assumptions. Therefore, the inclusion of the proposed development flows and traffic growth will lead to an element of double counting and provide a robust assessment of the local highway network.

Assessment Scenarios

- 7.7 The above junctions have been tested for the following scenarios during the morning and evening peak hours:
- 2022 Base – weekday morning and evening peak hours;
 - 2027 Base – weekday morning and evening peak hour; and
 - 2027 Base + Proposed Development – weekday morning and evening peak hours.

Assessment Methodology

- 7.8 The capacity analysis of the signalised junction (A414 North Orbital / High Street – signalised junction) has been undertaken using the industry standard LINSIG computer software and the priority and roundabouts junctions with 'Junctions 10' software.
- 7.9 LINSIG determines the capacity of signalised junctions by measuring the Degree of Saturation (DoS). The DoS is the ratio of traffic flow to saturation capacity on a link and if this value is over 100 per cent it means there is more traffic trying to pass through the junction than can be accommodated in a 1-hour period.
- 7.10 The results of the Junctions 10 assessment for the priority and roundabout junctions provides a ratio of flow to capacity (RFC) figure and a Queue (Q) length (number of vehicles). The RFC determines how the arm of the junction is operating and if the RFC is 0.85 or less the relevant arm of the junctions is within its design capacity with minimal queues. An RFC greater than 0.85 and less than 1.0 shows that the junction is operating close to its design capacity and as such some queues and delays may start to occur. When an RFC is greater than 1.0 the arm of the junction is operating at or exceeding its design capacity and as a result longer delays / queues will start to form. On this basis a maximum RFC of 1 will be used as the absolute capacity of a junction. Should the level of traffic at a junction exceed this threshold then mitigation may be required. Queue results represent an average queue length, so will not always be whole numbers of vehicles.
- 7.11 The copies of the LINSIG assessment for the signalised junctions are provided at **Appendix 14** and the copies of the Junctions 10 assessments for the priority and roundabout junctions are provided at **Appendix 15**. The following assessment has been undertaken.

A414 North Orbital / High Street – signalised junction

- 7.12 The A414 North Orbital / High Street – signalised junction has been modelled using the industry standard LINSIG computer software and signal timings provided by HCC.
- 7.13 The tables below provide the summary results of the capacity assessment based on the 2022 Base, 2027 Base and 2027 Base + Proposed scenarios.

Table 7.1: 2022 Base

Arm	2022 Base AM Peak		2022 Base PM Peak	
	Degree of Saturation	Mean Max Queue	Degree of Saturation	Mean Max Queue
1/1 A414 N Orbital Rd (West) Ahead	67.1%	14.3	60.9%	12.0
1/2 A414 N Orbital Rd (West) Ahead	67.0%	14.3	60.8%	12.0
2/2 + 2/1 A414 N Orbital Rd (East) Left Ahead	93.3 : 93.3%	28.4	93.0 : 93.0%	28.7
2/3 A414 N Orbital Rd (East) Ahead	90.1%	25.2	89.7%	25.5
3/1 + 3/2 High Street Left Ahead	91.0 : 91.0%	13.5	92.9 : 92.9%	13.9
7/1 Right turn	13.1%	0.1	14.2%	0.1

Table 7.2: 2027 Base

Arm	2027 Base AM Peak		2027 Base PM Peak	
	Degree of Saturation	Mean Max Queue	Degree of Saturation	Mean Max Queue
1/1 A414 N Orbital Rd (West) Ahead	68.1%	14.8	61.8%	12.4
1/2 A414 N Orbital Rd (West) Ahead	68.0%	14.6	61.8%	12.4
2/2 + 2/1 A414 N Orbital Rd (East) Left Ahead	94.5 : 94.5%	30.3	94.1 : 94.1%	30.5
2/3 A414 N Orbital Rd (East) Ahead	91.8%	26.9	91.4%	27.3
3/1 + 3/2 High Street Left Ahead	92.4 : 92.4%	14.5	94.4 : 94.4%	14.9
7/1 Right turn	13.3%	0.1	14.4%	0.1

Table 7.3: 2027 Base

Arm	2027 Base AM Peak		2027 Base PM Peak	
	Degree of Saturation	Mean Max Queue	Degree of Saturation	Mean Max Queue
1/1 A414 N Orbital Rd (West) Ahead	68.1%	14.8	61.8%	12.4
1/2 A414 N Orbital Rd (West) Ahead	68.0%	14.6	61.8%	12.4
2/2 + 2/1 A414 N Orbital Rd (East) Left Ahead	94.5 : 94.5%	30.3	94.1 : 94.1%	30.5
2/3 A414 N Orbital Rd (East) Ahead	91.8%	26.9	91.4%	27.3
3/1 + 3/2 High Street Left Ahead	92.4 : 92.4%	14.5	94.4 : 94.4%	14.9
7/1 Right turn	13.3%	0.1	14.4%	0.1

Table 7.4: 2027 Base + Proposed

Arm	2027 Base AM Peak		2027 Base PM Peak	
	Degree of Saturation	Mean Max Queue	Degree of Saturation	Mean Max Queue
1/1 A414 N Orbital Rd (West) Ahead	69.3%	15.1	62.9%	12.7
1/2 A414 N Orbital Rd (West) Ahead	69.2%	15.1	62.9%	12.7
2/2 + 2/1 A414 N Orbital Rd (East) Left Ahead	96.3 : 96.3%	33.6	95.9 : 95.9%	33.7
2/3 A414 N Orbital Rd (East) Ahead	93.8%	28.8	93.8%	29.4
3/1 + 3/2 High Street Left Ahead	93.3 : 93.3%	15.6	92.6 : 92.6%	14.1
7/1 Right turn	14.2%	0.1	14.9	0.1

- 7.14 The above results indicate that all arms of the junction return a degree of saturation below 100%.
- 7.15 Comparisons between the 2027 Base and 2027 Base and Proposed degree of saturation and queue lengths, indicate that overall, the proposed development will have minimal impact at the junction during the morning and evening peak periods.

High Street, Roestock Lane, Tollgate Road, Courses Road – Roundabout Junction

- 7.16 The capacity of the roundabout junction has been tested using Junctions 10.
- 7.17 The tables below provide the summary results of the capacity assessment undertaken for the 2022 Base, 2027 Base and 2027 Base + Proposed Scenarios.

Table 7.5: 2022 Base

Arm	2022 Base AM Peak		2022 Base PM Peak	
	RFC	Q	RFC	Q
Roestock Lane	0.17	0.2	0.10	0.1
Tollgate Road	0.60	1.5	0.39	0.6
Coursers Road	0.44	0.8	0.55	1.2
High Street	0.29	0.4	0.34	0.5

Table 7.6: 2027 Base

Arm	2027 Base AM Peak		2027 Base PM Peak	
	RFC	Q	RFC	Q
Roestock Lane	0.17	0.2	0.10	0.1
Tollgate Road	0.62	1.6	0.39	0.6
Coursers Road	0.45	0.8	0.56	1.3
High Street	0.30	0.4	0.34	0.5

Table 7.7: 2027 Base + Proposed

Arm	2027 Base + Proposed AM Peak		2027 Base + Proposed PM Peak	
	RFC	Q	RFC	Q
Roestock Lane	0.17	0.2	0.11	0.1
Tollgate Road	0.66	1.9	0.42	0.7
Coursers Road	0.47	0.9	0.58	1.4
High Street	0.31	0.4	0.36	0.5

7.18 The above results show that existing roundabout will operate within its design capacity with minimal delays experienced. It is clear the additional traffic associated with the proposed development will not materially affect the operation of the roundabout junction and will be imperceptible to other road users.

Tollgate Road / Fellowes Lane – Existing Priority Junction

7.19 The capacity of the priority junction has been tested using Junctions 10.

7.20 The tables below provide the summary results of the capacity assessment undertaken for the 2022 Base and 2027 Base.

Table 7.8: 2022 Base

Arm	2022 Base AM Peak		2022 Base PM Peak	
	RFC	Q	RFC	Q
B-C Fellowes Lane to Tollgate Road South	0.00	0.0	0.00	0.0
B-A Fellowes Lane to Tollgate Road North	0.05	0.1	0.03	0.0
C-AB Tollgate Road South to Fellowes Lane and Tollgate Road North	0.01	0.0	0.00	0.0

Table 7.9: 2027 Base

Arm	2027 Base AM Peak		2027 Base PM Peak	
	RFC	Q	RFC	Q
B-C Fellowes Lane to Tollgate Road South	0.00	0.0	0.00	0.0
B-A Fellowes Lane to Tollgate Road North	0.05	0.1	0.03	0.0
C-AB Tollgate Road South to Fellowes Lane and Tollgate Road North	0.01	0.0	0.00	0.0

7.21 The above results show that existing priority junction will operate within its design capacity with minimal delays experienced in both the 2022 and 2027 base scenarios.

Tollgate Road / Fellowes Lane / Site Access – Proposed Priority Junction

7.22 The capacity of the proposed site access and junction with Fellowes Lane has been tested using Junctions 10.

Table 7.10: 2027 Base + Proposed

Arm	2027 Base + Proposed AM Peak		2027 Base + Proposed PM Peak	
	RFC	Q	RFC	Q
B-CD Site Access to Tollgate Road North and Fellowes Lane	0.06	0.1	0.03	0.0
B-AD Site Access to Tollgate Road South and Fellowes Lane	0.04	0.0	0.02	0.0
A-BCD Tollgate Road South to Site Access, Tollgate Road North and Fellowes Lane	0.01	0.0	0.00	0.0
D-ABC Fellowes Lane to Tollgate Road South, Site Access and Tollgate Road North	0.07	0.1	0.04	0.0
C-ABD Tollgate Road North Tollgate Road South, Site Access and Fellowes Lane	0.04	0.1	0.08	0.2

7.23 The above results show that existing priority junction will operate within its design capacity with minimal delays experienced for the 2027 base + proposed scenario.

Dixons Hill Road / Swanland Road – Priority Junction

7.24 The capacity of the priority junction has been tested using Junctions 9.

7.25 The tables below provide the summary results of the capacity assessment undertaken for the 2022 Base, 2027 Base and 2027 Base + Proposed Scenarios.

Table 7.11: 2022 Base

Arm	2022 Base AM Peak		2022 Base PM Peak	
	RFC	Q	RFC	Q
B – C Swanland Road to Dixons Hill West	0.16	0.2	0.17	0.2
B- A Swanland Road to Dixon Hill Road East	0.47	0.9	0.49	0.9
C-AB Dixons Hill Road West to Dixons Hills Road East and Swansland Road	0.19	0.3	0.16	0.3

Table 7.12: 2027 Base

Arm	2027 Base AM Peak		2027 Base PM Peak	
	RFC	Q	RFC	Q
B – C Swanland Road to Dixons Hill West	0.17	0.2	0.18	0.2
B- A Swanland Road to Dixon Hill Road East	0.49	0.9	0.50	1.0
C-AB Dixons Hill Road West to Dixons Hills Road East and Swansland Road	0.19	0.3	0.16	0.3

Table 7.13: 2027 Base + Proposed

Arm	2027 Base + Proposed AM Peak		2027 Base + Proposed PM Peak	
	RFC	Q	RFC	Q
B – C Swanland Road to Dixons Hill West	0.17	0.2	0.19	0.2
B- A Swanland Road to Dixon Hill Road East	0.49	1.0	0.51	1.0
C-AB Dixons Hill Road West to Dixons Hills Road East and Swansland Road	0.21	0.4	0.17	0.3

- 7.26 The above results show that existing priority junction will operate within its design capacity with minimal delays experienced. It is clear the additional traffic associated with the proposed development will not materially affect the operation of the priority junction and will be imperceptible to other road users.

A1000 Great North Road / Dixons Hill Road – Roundabout Junction

- 7.27 The capacity of the roundabout junction has been tested using Junctions 9.
- 7.28 The tables below provide the summary results of the capacity assessment undertaken for the 2022 Base, 2027 Base and 2027 Base + Proposed Scenarios.

Table 7.14: 2022 Base

Arm	2022 Base AM Peak		2022 Base PM Peak	
	RFC	Q	RFC	Q
Great North Road (S)	0.60	1.5	0.39	0.6
Dixon Hill Road	0.50	1.0	0.67	2.0
Great North Road (N)	0.81	4.1	0.74	2.7

Table 7.15: 2027 Base

Arm	2027 Base AM Peak		2027 Base PM Peak	
	RFC	Q	RFC	Q
Great North Road (S)	0.61	1.6	0.40	0.7
Dixon Hill Road	0.51	1.0	0.69	2.2
Great North Road (N)	0.82	4.4	0.75	2.9

Table 7.16: 2027 Base + Proposed

Arm	2027 Base + Proposed AM Peak		2027 Base + Proposed PM Peak	
	RFC	Q	RFC	Q
Great North Road (S)	0.61	1.6	0.40	0.7
Dixon Hill Road	0.52	1.1	0.69	2.2
Great North Road (N)	0.83	4.5	0.75	3.0

7.29 The above results show that existing roundabout will operate within its design capacity with minimal delays experienced. It is clear the additional traffic associated with the proposed development will not materially affect the operation of the roundabout junction and will be imperceptible to other road users.

Tollgate Road – On Street Parking and Operation

7.30 The results of the traffic survey indicate that Tollgate Road is relatively lightly trafficked in the morning and evening peak hours. Tollgate Road operates well within its link capacity, which means that free flow conditions will be normal. The parking beat survey identified that on street parking occurs on the northern side of Tollgate Road to the east of the junction with Fellowes Lane. The parking beat survey provides a snap shot of parking demand and recorded a maximum parking stress of 14 vehicles (41% occupancy) and 20 spare spaces. The spare spaces would allow southbound vehicles on Tollgate Road room to pull in and give way to oncoming vehicles. It has been observed on site that this can result in minor delays for traffic as they negotiate the on-street parking, but also provides a traffic calming effect.

- 7.31 The impact of the development traffic on Tollgate Road and on-street parking has been modelled using Junctions 10. Junctions 10 provides the ability to simulate situations where traffic in one direction gives way to traffic from the other direction.
- 7.32 The simulation provides the delay in seconds and a vehicle queue length for the vehicles travelling north and southbound on Tollgate Road.
- 7.33 The tables below provide the summary results of the assessment undertaken for the 2022 Base, 2027 Base and 2027 Base + Proposed Scenarios.

Table 7.17: 2022 Base

Arm	2022 Base AM Peak		2022 Base PM Peak	
	Delay (s)	Q	Delay (s)	Q
1 – Tollgate Road South	3.66	0.4	3.56	0.4
2 – Tollgate Road North	3.22	0.3	0.19	0.1

Table 7.18: 2027 Base

Arm	2027 Base AM Peak		2027 Base PM Peak	
	Delay (s)	Q	Delay (s)	Q
1 – Tollgate Road South	3.65	0.5	3.47	0.4
2 – Tollgate Road North	5.02	0.6	0.45	0.0

Table 7.19: 2027 Base + Proposed

Arm	2027 Base + Proposed AM Peak		2027 Base + Proposed PM Peak	
	Delay (s)	Q	Delay (s)	Q
1 – Tollgate Road South	3.69	0.5	3.52	0.3
2 – Tollgate Road North	8.22	1.0	0.41	0.0

- 7.34 Comparisons between the 2027 Base and 2027 Base and Proposed delay and queue lengths, indicate that overall, the proposed development will have minimal impact on the operation of Tollgate Road in the morning and evening peak periods.

Summary

- 7.35 The traffic impact analysis undertaken as part this TA calculates the proposed development trip generation and resultant vehicular movements in the future year against the base scenario.

7.36 The NPPF states in paragraph 111:

“Development should only be prevented or refused on highways grounds if there would be an unacceptable impact on highway safety, or the residual cumulative impacts on the road network would be severe.”

7.37 The analysis undertaken has demonstrated that the proposed development will not have a ‘severe’; impact on the road network, and that the means of access is safe for all road users.

8 SUMMARY AND CONCLUSION

- 8.1 RPS has been instructed by Vistry Group to undertake a Transport Assessment (TA) of a proposed residential site located on land to the south of Tollgate Road, Colney Heath, Hertfordshire. The site is within the district of St Albans City and District and Hertfordshire County Council (HCC) are the Highway Authority.
- 8.2 This TA has been prepared in accordance with national and local guidance, and pre-application scoping discussions with HCC the local highway authority.
- 8.3 The site comprises 7.62ha of land located south of the existing residential area Colney Heath, south east of North Orbital A414 and west of A1. The site is bounded by existing residential dwellings and Tollgate Road to the north, the River Colne to the south. The site is bounded by farmland to the east and west.
- 8.4 It is proposed that the development is served by a single access via Tollgate Road at the north west corner of the site. The access requires the demolition of property No. 42 Tollgate Road to form a priority junction on the southern side of Tollgate Road. The access has been provided with a 6m carriageway width and 2m footways on both sides that tie into the existing footway provision.
- 8.5 The site access is located opposite the junction with Fellowes Lane. It is proposed that the both the site access and Fellowes Lane junction are traffic calmed by the provision of a raised table. In addition, a new section of footway is proposed on the north side of Tollgate Road to the west of junction with Fellowes Lane. This will provide a continuous east / west footway provision on the northern side of Tollgate Road adjacent to the site access.
- 8.6 In terms of the development site, its location benefits from good accessibility to existing bus services and reasonable access to rail services. Local facilities including shops and schools are all accessible by walking and cycling. The site will therefore provide residents with realistic sustainable travel choices to the private car for some journeys.
- 8.7 The proposed residential development provides the opportunity to improve the existing bus services via planning obligations towards sustainable transport. The contribution towards sustainable transport improvements will be in accordance with Hertfordshire County Councils Planning Obligations Guidance – Toolkit for Hertfordshire – January 2008.
- 8.8 The impact of the new housing on the local road network has been assessed and shows that the proposed development will not cause any safety issues or have any significant impact on highway capacity.
- 8.9 In conclusion, the proposed development is sustainable with good accessibility to local facilities, offers a good choice of sustainable transport modes, and has no significant impact on the highway network. As such there are no transport reasons why the development should not be permitted.

Appendices

Appendix 1 – Site Context Plan

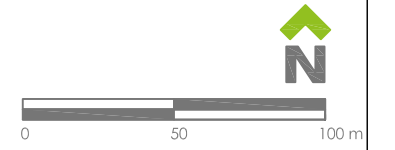
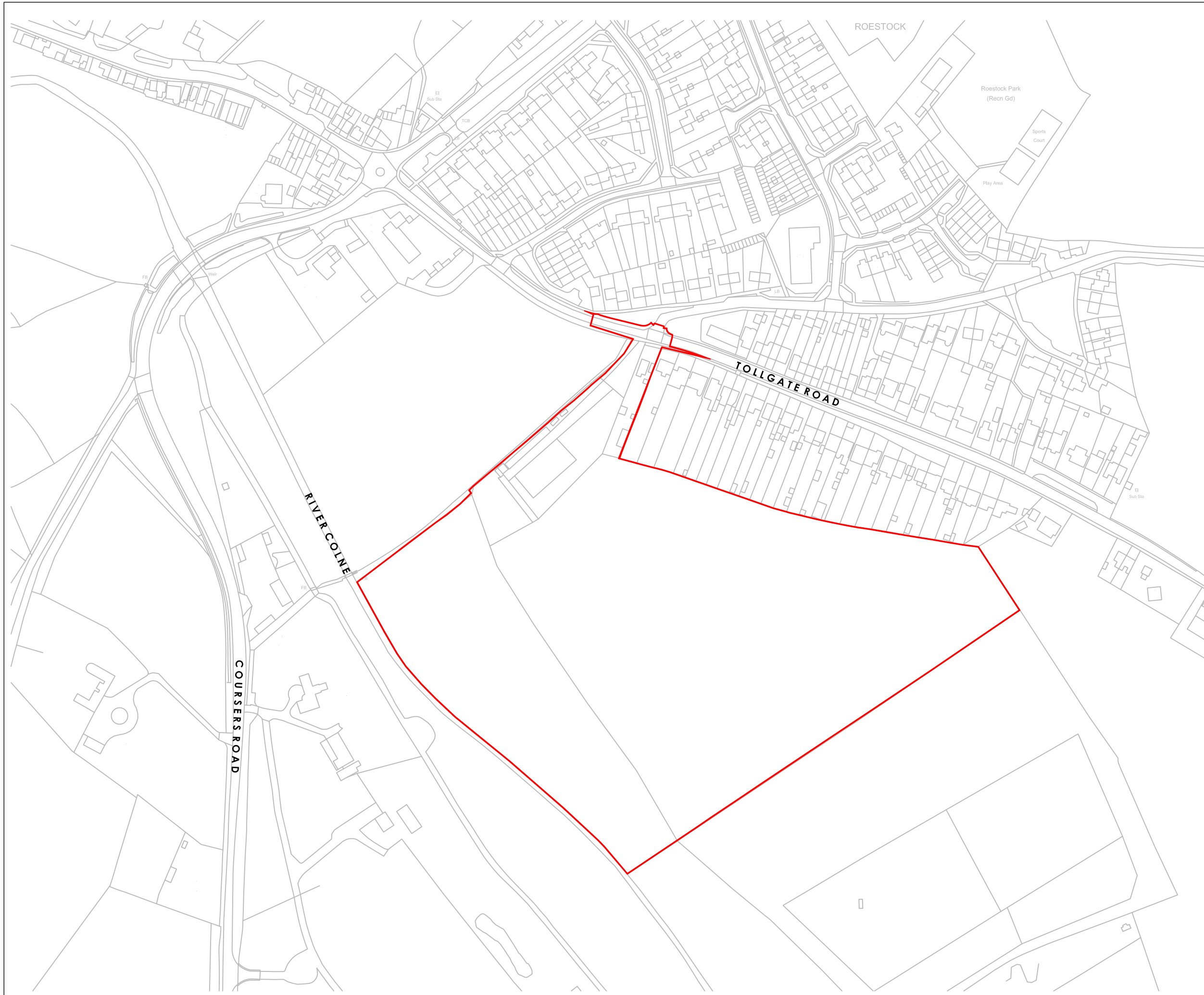

 Site Boundary: **7.82ha**

D	24.06.2022	JC	project name update
C	21.06.2022	JC	Minor Red Line Update
B	21.06.2022	JC	Highways land included
A	08.02.2022	JC	Additional land included

Rev	Date	By	Description
-----	------	----	-------------

CSA
environmental

Dixies Barns, High Street,
Ashwell, Hertfordshire SG7 5NT

t 01462 743647
e ashwell@csaenvironmental.co.uk
w csaenvironmental.co.uk

Project Land at Tollgate Road
COLNEY HEATH

Title Site Location Plan

Client Vistry Group

Scale 1:2500 @ A3 **Drawn** SG

Date March 2021 **Checked** RR

Drawing No. CSA/3925/109 **Rev** D

Appendix 2 – Collision Data

Full Confidential Accident Report

Date Produced: 18-May-22

Set Name (if saved) : 25650_A414

Set Total : 1

Accident Details:

Acc Ref: 2017-410183974 **1st / 2nd Rd:** C174/22 A414/07 **Jun Detail:** T **Weather:** Rain **Num Cas:** 1
Day of Week: Thu **Parish:** **Jun Control:** Giveway **Light:** Day **Num Peds:** 0
Date: 11/05/2017 17:30:00 **District:** StAlbs **Spec Conditions:** None **Road Surface:** Wet **Num Vehicles:** 2
Acc Severity: Slight **Speed Limit:** 30mph **C/way Hazard:** None **C/way Type:** Single **Ped Xing:** Npernox
C174 High Street Colney Heath Approx 20m South J/w A141 North Orbital Road **On Site:** Yes

Both Vs Cars (assumed) Trav Sw On North Orbital Road. V2 In Lane 2 Has Changed Lane To Left Forcing V1 In Lane 1 To Take Evasive Action And Steer To N/s Into High Street At Speed. V1 Has Clipped O/s Kerb Before Leaving C/way N/s Colliding With Lamp Post. V2 Fts. Driver V2 Using Mobile Phone

Eastings: 519729 **Northings:** 206317

Contributory Factors

Participant	Confidence	Factor 1	2	3	4	5	6
V 1	A	Slipnowe				Newdrivr	
V 2	A		Mobileph	Flookdri	Misspeed		

Casualty Details

Acc Ref: 2017-410183974 **Cas Class:** Driver **Car Passenger:** No **Cas Severity:** Slight **Ped Movement:** Notped
Veh Ref: 1 **Cas Age:** 25 **PSV Passenger:** No **Road User Class:** Car Users **Ped Location:** Notped
Cas Ref: 1 **Cas Gender:** Male **Seat Belt:** Wornnot **School Pupil:** **Ped Work on Rd:** Notped

Vehicle Details

Acc Ref: 148658 **Manoeuvre:** Ahead **Skidding:** Skidded **Impact Point:** Offside **Driver Breath Test:** Notreq **Driver Age:** 25
Veh Ref: 1 **Location:** Carw **Object in Cway:** Kerb **From:** Ne **Hit and Run:** Nothtrun
Veh Type: Car **Junction:** Lmain **Object off Cway** Lamppost **To:** S **Driver Gender:** Male
Foreign Veh: **Towing;** None **velcwy** Nearside **J Purpose:** Unknown **Driver Severity:** Slight

Acc Ref: **Manoeuvre:** Chglnlef **Skidding:** None **Impact Point:** None **Driver Breath Test:** Notcon **Driver Age:**
Veh Ref: 2 **Location:** Carw **Object in Cway:** None **From:** Ne **Hit and Run:** Nonstop
Veh Type: Car **Junction:** Approach **Object off Cway** None **To:** Sw **Driver Gender:** Unknown
Foreign Veh: **Towing;** None **velcwy** No **J Purpose:** Unknown **Driver Severity:** None

Full Confidential Accident Report

Date Produced: 18-May-22

Set Name (if saved) : 25650_A1000Rbt

Set Total : 1

Accident Details:

Acc Ref: 2018-410316372 **1st / 2nd Rd:** A1000/2 A1000/2 **Jun Detail:** R/bout **Weather:** Fine **Num Cas:** 1
Day of Week: Fri **Parish:** **Jun Control:** Giveway **Light:** Darklit **Num Peds:** 0
Date: 20/07/2018 01:43:00 **District:** WelHat **Spec Conditions:** None **Road Surface:** Dry **Num Vehicles:** 1
Acc Severity: Slight **Speed Limit:** 40mph **C/way Hazard:** None **C/way Type:** Single **Ped Xing:** Npernox
A1000 Great North Road Welham Green J/w A1000 Dixons Hill Rbt **On Site:** Yes

V1 Car Trav Nw On Great North Road At Speed Has Entered Rbt & Lost Control Leaving C/way To N/s Colliding With Lamp Post & Bushes

Easting: 523813 **Northing:** 205892**Contributory Factors**

Participant	Confidence	Factor 1	2	3	4	5	6
V 1	A	Speeding	Toofast				

Casualty Details

Acc Ref: 2018-410316372 **Cas Class:** Driver **Car Passenger:** No **Cas Severity:** Slight **Ped Movement:** Notped
Veh Ref: 1 **Cas Age:** 26 **PSV Passenger:** No **Road User Class:** Car Users **Ped Location:** Notped
Cas Ref: 1 **Cas Gender:** Male **Seat Belt:** Wornnot **School Pupil:** **Ped Work on Rd:** Notped

Vehicle Details

Acc Ref: 151216 **Manoeuvre:** Ahead **Skidding:** None **Impact Point:** Front **Driver Breath Test:** Negati **Driver Age:** 26
Veh Ref: 1 **Location:** Carw **Object in Cway:** None **From:** Se **Hit and Run:** Nothtrun
Veh Type: Car **Junction:** Lr/about **Object off Cway** Lamppost **To:** Nw **Driver Gender:** Male
Foreign Veh: **Towing;** None **velcwy** Nearside **J Purpose:** Unknown **Driver Severity:** Slight

Full Confidential Accident Report

Date Produced: 18-May-22

Set Name (if saved) : 25650_FellowsLane

Set Total : 1

Accident Details:

Acc Ref: 2019-410892619 **1st / 2nd Rd:** C174/20 NONE **Jun Detail:** Notjunct **Weather:** Rain **Num Cas:** 1
Day of Week: Tue **Parish:** **Jun Control:** Notjunct **Light:** Day **Num Peds:** 0
Date: 15/10/2019 07:00:00 **District:** StAlbs **Spec Conditions:** None **Road Surface:** Wet **Num Vehicles:** 2
Acc Severity: Serious **Speed Limit:** 30mph **C/way Hazard:** None **C/way Type:** Single **Ped Xing:** Npernox
C174 Tollgate Road Colney Heath O/s No 63 & Approx 90m East J/w U1386 Fellows Lane **On Site:** Yes

Traffic Stationary On Tollgate Road To Allow V2 Car To Perform U Turn In C/way O/s No 63. V1 M/c 125cc Overtaking Stationary Traffic Trav East Has Failed To See V2 Until Last Minute, Skidded & Rider Has Fallen

Easting: 520942 **Northing:** 205655

Contributory Factors

Participant	Confidence	Factor 1	2	3	4	5	6
V 1	A	Flookdri	Stopping	Lostcont			

Casualty Details

Acc Ref: 2019-410892619 **Cas Class:** Driver **Car Passenger:** No **Cas Severity:** Serious **Ped Movement:** Notped
Veh Ref: 1 **Cas Age:** 46 **PSV Passenger:** No **Road User Class:** Motorcyclists **Ped Location:** Notped
Cas Ref: 1 **Cas Gender:** Male **Seat Belt:** Notapp **School Pupil:** **Ped Work on Rd:** Notped

Vehicle Details

Acc Ref: 153521 **Manoeuvre:** Otakesta **Skidding:** None **Impact Point:** Offside **Driver Breath Test:** Ntprov **Driver Age:** 46
Veh Ref: 1 **Location:** Carw **Object in Cway:** None **From:** W **Hit and Run:** Nothtrun
Veh Type: Mc<=125 **Junction:** Notjunct **Object off Cway:** None **To:** E **Driver Gender:** Male
Foreign Veh: **Towing;** None **velcwy:** No **J Purpose:** Tofrowrk **Driver Severity:** Serious

Acc Ref: **Manoeuvre:** Uturn **Skidding:** None **Impact Point:** None **Driver Breath Test:** Notreq **Driver Age:** 49
Veh Ref: 2 **Location:** Carw **Object in Cway:** None **From:** W **Hit and Run:** Nothtrun
Veh Type: Car **Junction:** Notjunct **Object off Cway:** None **To:** W **Driver Gender:** Male
Foreign Veh: **Towing;** None **velcwy:** No **J Purpose:** Tofrowrk **Driver Severity:** None

Full Confidential Accident Report

Date Produced: 18-May-22

Set Name (if saved) : 25650_SwanlandRoad

Set Total : 9

Accident Details:

Acc Ref: 2019-410862305 **1st / 2nd Rd:** C56/10 C174/11 **Jun Detail:** T **Weather:** Fine **Num Cas:** 1
Day of Week: Tue **Parish:** **Jun Control:** Giveway **Light:** Day **Num Peds:** 0
Date: 09/07/2019 08:23:00 **District:** WelHat **Spec Conditions:** None **Road Surface:** Dry **Num Vehicles:** 2
Acc Severity: Slight **Speed Limit:** 60mph **C/way Hazard:** None **C/way Type:** Single **Ped Xing:** Npernox
C56 Dixons Hill Road North Mymms J/w C174 Swanland Road **On Site:** Yes

V2 Car Trav Se On Dixons Hill Road Passing Jct When V1 Car Pulled Out Of Swanland Road From N/s & Collided With V2

Easting: 522594 **Northing:** 204758**Contributory Factors**

Participant	Confidence	Factor 1	2	3	4	5	6
V 1	A	Flooddri					

Casualty Details

Acc Ref: 2019-410862305 **Cas Class:** Driver **Car Passenger:** No **Cas Severity:** Slight **Ped Movement:** Notped
Veh Ref: 1 **Cas Age:** 27 **PSV Passenger:** No **Road User Class:** Car Users **Ped Location:** Notped
Cas Ref: 1 **Cas Gender:** Female **Seat Belt:** Unknown **School Pupil:** **Ped Work on Rd:** Notped

Vehicle Details

Acc Ref: 153070 **Manoeuvre:** Starting **Skidding:** None **Impact Point:** Front **Driver Breath Test:** Notreq **Driver Age:** 27
Veh Ref: 1 **Location:** Carw **Object in Cway:** None **From:** Se **Hit and Run:** Nothtrun
Veh Type: Car **Junction:** Emain **Object off Cway** None **To:** Nw **Driver Gender:** Female
Foreign Veh: **Towing;** None **velcwy** No **J Purpose:** Work **Driver Severity:** Slight

Acc Ref: **Manoeuvre:** Ahead **Skidding:** None **Impact Point:** Nearside **Driver Breath Test:** Ntprov **Driver Age:** 72
Veh Ref: 2 **Location:** Carw **Object in Cway:** None **From:** Nw **Hit and Run:** Nothtrun
Veh Type: Car **Junction:** Middle **Object off Cway** None **To:** Se **Driver Gender:** Male
Foreign Veh: **Towing;** None **velcwy** No **J Purpose:** Work **Driver Severity:** None

Accident Details:

Acc Ref: 2017-410215556 **1st / 2nd Rd:** C56/10 C174/11 **Jun Detail:** T **Weather:** Fine **Num Cas:** 1
Day of Week: Thu **Parish:** **Jun Control:** Giveway **Light:** Day **Num Peds:** 0
Date: 31/08/2017 10:40:00 **District:** WelHat **Spec Conditions:** None **Road Surface:** Dry **Num Vehicles:** 2
Acc Severity: Serious **Speed Limit:** 60mph **C/way Hazard:** None **C/way Type:** Single **Ped Xing:** Npernox
C56 Dixons Hill Road North Mymms J/w C174 Swanland Road **On Site:** Yes

V2 Mc 125-500cc Trav Sw On Dixons Hill Road Approaching Jct. V1 Lgv Trav Ne Turned Rt At Jct Across The Path Of V2. V2 Collided With N/s V1

Easting: 522599 **Northing:** 204760

Contributory Factors

Participant	Confidence	Factor 1	2	3	4	5	6
V 1	A	Flookdri					
V 1	B		Misspeed				

Casualty Details

Acc Ref: 2017-410215556 **Cas Class:** Driver **Car Passenger:** No **Cas Severity:** Serious **Ped Movement:** Notped
Veh Ref: 2 **Cas Age:** 35 **PSV Passenger:** No **Road User Class:** Motorcyclists **Ped Location:** Notped
Cas Ref: 1 **Cas Gender:** Male **Seat Belt:** Notapp **School Pupil:** **Ped Work on Rd:** Notped

Vehicle Details

Acc Ref: 149875 **Manoeuvre:** Turnrigh **Skidding:** None **Impact Point:** Nearside **Driver Breath Test:** Negati **Driver Age:** 33
Veh Ref: 1 **Location:** Carw **Object in Cway:** None **From:** Sw **Hit and Run:** Nothtrun
Veh Type: Gdltwght **Junction:** Lmain **Object off Cway** None **To:** Se **Driver Gender:** Male
Foreign Veh: **Towing;** None **velewy** No **J Purpose:** Other **Driver Severity:** None

Acc Ref: **Manoeuvre:** Ahead **Skidding:** None **Impact Point:** Front **Driver Breath Test:** Ntprov **Driver Age:** 35
Veh Ref: 2 **Location:** Carw **Object in Cway:** None **From:** Ne **Hit and Run:** Nothtrun
Veh Type: Mc<=500 **Junction:** Middle **Object off Cway** None **To:** Sw **Driver Gender:** Male
Foreign Veh: **Towing;** None **velewy** No **J Purpose:** Other **Driver Severity:** Serious

Accident Details:

Acc Ref: 2019-410909883 **1st / 2nd Rd:** C56/10 C174/11 **Jun Detail:** T **Weather:** Fine **Num Cas:** 3
Day of Week: Tue **Parish:** **Jun Control:** Giveway **Light:** Day **Num Peds:** 0
Date: 17/09/2019 16:45:00 **District:** WelHat **Spec Conditions:** None **Road Surface:** Dry **Num Vehicles:** 4
Acc Severity: Slight **Speed Limit:** 40mph **C/way Hazard:** None **C/way Type:** Single **Ped Xing:** Npernox
C56 Dixons Hill Road North Mymms J/w C174 Swanland Road **On Site:** Yes

V1 Lgv Trav Ne On Dixons Hill Road Has Turned Right Into Swanland Across Path V2 Car Trav Sw. V2 Has Collided With N/s V1 Pushing V1 Into V3 Car Trav Ne On Swanland Road & Waiting At Jct. V4 Car Following V2 Trav Sw Has Collided With Rear V2

Easting: 522602 **Northing:** 204760

Contributory Factors

Participant	Confidence	Factor 1	2	3	4	5	6
V 1	A	Floodri					

Casualty Details

Acc Ref: 2019-410909883 **Cas Class:** Driver **Car Passenger:** No **Cas Severity:** Slight **Ped Movement:** Notped
Veh Ref: 2 **Cas Age:** 68 **PSV Passenger:** No **Road User Class:** Car Users **Ped Location:** Notped
Cas Ref: 1 **Cas Gender:** Female **Seat Belt:** Wornnot **School Pupil:** **Ped Work on Rd:** Notped

Acc Ref: 2019-410909883 **Cas Class:** Passenge **Car Passenger:** No **Cas Severity:** Slight **Ped Movement:** Notped
Veh Ref: 1 **Cas Age:** **PSV Passenger:** No **Road User Class:** Goods Vehicles **Ped Location:** Notped
Cas Ref: 2 **Cas Gender:** Female **Seat Belt:** Wornnot **School Pupil:** **Ped Work on Rd:** Notped

Acc Ref: 2019-410909883 **Cas Class:** Passenge **Car Passenger:** No **Cas Severity:** Slight **Ped Movement:** Notped
Veh Ref: 1 **Cas Age:** **PSV Passenger:** No **Road User Class:** Goods Vehicles **Ped Location:** Notped
Cas Ref: 3 **Cas Gender:** Female **Seat Belt:** Wornnot **School Pupil:** **Ped Work on Rd:** Notped

Vehicle Details

Acc Ref: 153761 **Manoeuvre:** Turnrigh **Skidding:** None **Impact Point:** Nearside **Driver Breath Test:** Notreq **Driver Age:** 23
Veh Ref: 1 **Location:** Carw **Object in Cway:** None **From:** Sw **Hit and Run:** Nothtrun
Veh Type: Gdltwght **Junction:** Lmain **Object off Cway:** None **To:** Se **Driver Gender:** Female
Foreign Veh: **Towing:** None **velcwy:** No **J Purpose:** Unknown **Driver Severity:** None

Acc Ref:	Manoeuvre: Ahead	Skidding: None	Impact Point: Front	Driver Breath Test: Notreq	Driver Age: 68
Veh Ref: 2	Location: Carw	Object in Cway: None	From: Ne	Hit and Run: Nothtrun	
Veh Type: Car	Junction: Middle	Object off Cway: None	To: Sw	Driver Gender: Female	
Foreign Veh:	Towing; None	velcwy No	J Purpose: Unknown	Driver Severity: Slight	

Acc Ref:	Manoeuvre: Waitrigh	Skidding: None	Impact Point: Front	Driver Breath Test: Notreq	Driver Age: 44
Veh Ref: 3	Location: Carw	Object in Cway: None	From: Se	Hit and Run: Nothtrun	
Veh Type: Car	Junction: Approach	Object off Cway: None	To: Ne	Driver Gender: Female	
Foreign Veh:	Towing; None	velcwy No	J Purpose: Unknown	Driver Severity: None	

Acc Ref:	Manoeuvre: Ahead	Skidding: None	Impact Point: Front	Driver Breath Test: Notreq	Driver Age: 56
Veh Ref: 4	Location: Carw	Object in Cway: None	From: Ne	Hit and Run: Nothtrun	
Veh Type: Car	Junction: Approach	Object off Cway: None	To: Sw	Driver Gender: Female	
Foreign Veh:	Towing; None	velcwy No	J Purpose: Unknown	Driver Severity: None	

Accident Details:

Acc Ref: 2017-410198378 **1st / 2nd Rd:** C56/10 C174/11 **Jun Detail:** T **Weather:** Fine **Num Cas:** 2
Day of Week: Fri **Parish:** **Jun Control:** Giveway **Light:** Day **Num Peds:** 0
Date: 23/06/2017 09:35:00 **District:** WelHat **Spec Conditions:** None **Road Surface:** Dry **Num Vehicles:** 2
Acc Severity: Serious **Speed Limit:** 60mph **C/way Hazard:** None **C/way Type:** Single **Ped Xing:** Npernox
C56 Dixons Hill Road Hatfield J/w C174 Swanland Road **On Site:** Yes

V2 Car Trav SW On Dixons Hill Road V1 Car NE/bound Stopped Waiting to Turn Right Into Swanland Road. V1 Started to turn Across Path V2 & Vs Collided

Easting: 522602 **Northing:** 204761

Contributory Factors

Participant	Confidence	Factor 1	2	3	4	5	6
V 1	A	Badrdlay	Misspeed				

Casualty Details

Acc Ref: 2017-410198378 **Cas Class:** Driver **Car Passenger:** No **Cas Severity:** Serious **Ped Movement:** Notped
Veh Ref: 1 **Cas Age:** 35 **PSV Passenger:** No **Road User Class:** Car Users **Ped Location:** Notped
Cas Ref: 1 **Cas Gender:** Female **Seat Belt:** Unknown **School Pupil:** **Ped Work on Rd:** Notped

Acc Ref: 2017-410198378 **Cas Class:** Driver **Car Passenger:** No **Cas Severity:** Slight **Ped Movement:** Notped
Veh Ref: 2 **Cas Age:** 64 **PSV Passenger:** No **Road User Class:** Car Users **Ped Location:** Notped
Cas Ref: 2 **Cas Gender:** Female **Seat Belt:** Unknown **School Pupil:** **Ped Work on Rd:** Notped

Vehicle Details

Acc Ref: 148916 **Manoeuvre:** Turnrigh **Skidding:** None **Impact Point:** Front **Driver Breath Test:** Negati **Driver Age:** 35
Veh Ref: 1 **Location:** Carw **Object in Cway:** None **From:** SW **Hit and Run:** Nothtrun
Veh Type: Car **Junction:** Lmain **Object off Cway:** None **To:** SE **Driver Gender:** Female
Foreign Veh: **Towing:** None **velcwy:** No **J Purpose:** Other **Driver Severity:** Serious

Acc Ref: **Manoeuvre:** Ahead **Skidding:** None **Impact Point:** Front **Driver Breath Test:** Negati **Driver Age:** 64
Veh Ref: 2 **Location:** Carw **Object in Cway:** None **From:** NE **Hit and Run:** Nothtrun
Veh Type: Car **Junction:** Middle **Object off Cway:** None **To:** SW **Driver Gender:** Female
Foreign Veh: **Towing:** None **velcwy:** No **J Purpose:** Other **Driver Severity:** Slight

Accident Details:

Acc Ref: 2018-410287025 **1st / 2nd Rd:** C56/10 C174/11 **Jun Detail:** T **Weather:** Fine **Num Cas:** 2
Day of Week: Sat **Parish:** **Jun Control:** Giveway **Light:** Day **Num Peds:** 0
Date: 31/03/2018 11:06:00 **District:** WelHat **Spec Conditions:** None **Road Surface:** Dry **Num Vehicles:** 2
Acc Severity: Slight **Speed Limit:** 60mph **C/way Hazard:** None **C/way Type:** Single **Ped Xing:** Npernox
C56 Dixons Hill Road Welham Green J/w C174 Swanland Road **On Site:** Yes

Both Vs Cars. V1 Trav East On Dixons Hill Road Has Turned Right Into Swanland Road Across Path V2 Trav West & Vs Have Collided

Easting: 522601 **Northing:** 204761

Contributory Factors

Participant	Confidence	Factor 1	2	3	4	5	6
V 1	A	Flookdri	Misspeed				

Casualty Details

Acc Ref: 2018-410287025 **Cas Class:** Driver **Car Passenger:** No **Cas Severity:** Slight **Ped Movement:** Notped
Veh Ref: 1 **Cas Age:** 22 **PSV Passenger:** No **Road User Class:** Car Users **Ped Location:** Notped
Cas Ref: 1 **Cas Gender:** Female **Seat Belt:** Wornnot **School Pupil:** **Ped Work on Rd:** Notped

Acc Ref: 2018-410287025 **Cas Class:** Driver **Car Passenger:** No **Cas Severity:** Slight **Ped Movement:** Notped
Veh Ref: 2 **Cas Age:** 59 **PSV Passenger:** No **Road User Class:** Car Users **Ped Location:** Notped
Cas Ref: 2 **Cas Gender:** Female **Seat Belt:** Wornnot **School Pupil:** **Ped Work on Rd:** Notped

Vehicle Details

Acc Ref: 150461 **Manoeuvre:** Turnrigh **Skidding:** None **Impact Point:** Front **Driver Breath Test:** Negati **Driver Age:** 22
Veh Ref: 1 **Location:** Carw **Object in Cway:** None **From:** W **Hit and Run:** Nothtrun
Veh Type: Car **Junction:** Lmain **Object off Cway:** None **To:** S **Driver Gender:** Female
Foreign Veh: **Towing:** None **velcwy:** No **J Purpose:** Other **Driver Severity:** Slight

Acc Ref: **Manoeuvre:** Ahead **Skidding:** None **Impact Point:** Front **Driver Breath Test:** Negati **Driver Age:** 59
Veh Ref: 2 **Location:** Carw **Object in Cway:** None **From:** E **Hit and Run:** Nothtrun
Veh Type: Car **Junction:** Middle **Object off Cway:** None **To:** W **Driver Gender:** Female
Foreign Veh: **Towing:** None **velcwy:** No **J Purpose:** Other **Driver Severity:** Slight

Accident Details:

Acc Ref: 2021-411080277 **1st / 2nd Rd:** C56/10 C174/11 **Jun Detail:** T **Weather:** Fine **Num Cas:** 2
Day of Week: Tue **Parish:** **Jun Control:** Giveway **Light:** Day **Num Peds:** 0
Date: 13/04/2021 17:00:00 **District:** WelHat **Spec Conditions:** None **Road Surface:** Dry **Num Vehicles:** 3
Acc Severity: Slight **Speed Limit:** 60mph **C/way Hazard:** None **C/way Type:** Single **Ped Xing:** Npernox
C56 Dixons Hill Road Hatfield J/w C174 Swanland Road North Mymms **On Site:** Yes

V3 Car Trav East On Dixons Hill Road Has Turned Right Into Swanland Road Across Path V2 Lgv Trav West. V2 Swerved But Has Collided With Front V3 & O/s V1 Waiting In Swanland Road To Turn Left Onto Dixons Hill Road

Easting: 522602 **Northing:** 204761

Casualty Details

Acc Ref: 2021-411080277 **Cas Class:** Driver **Car Passenger:** No **Cas Severity:** Slight **Ped Movement:** Notped
Veh Ref: 1 **Cas Age:** 75 **PSV Passenger:** No **Road User Class:** Car Users **Ped Location:** Notped
Cas Ref: 1 **Cas Gender:** Male **Seat Belt:** Unknown **School Pupil:** **Ped Work on Rd:** Notped

Acc Ref: 2021-411080277 **Cas Class:** Driver **Car Passenger:** No **Cas Severity:** Slight **Ped Movement:** Notped
Veh Ref: 3 **Cas Age:** 21 **PSV Passenger:** No **Road User Class:** Car Users **Ped Location:** Notped
Cas Ref: 2 **Cas Gender:** Female **Seat Belt:** Unknown **School Pupil:** **Ped Work on Rd:** Notped

Vehicle Details

Acc Ref: 156553 **Manoeuvre:** Waitleft **Skidding:** None **Impact Point:** Offside **Driver Breath Test:** Notreq **Driver Age:** 75
Veh Ref: 1 **Location:** Carw **Object in Cway:** None **From:** S **Hit and Run:** Nothtrun
Veh Type: Car **Junction:** Approach **Object off Cway:** None **To:** N **Driver Gender:** Male
Foreign Veh: **Towing;** None **velcwy:** No **J Purpose:** Other **Driver Severity:** Slight

Acc Ref: **Manoeuvre:** Ahead **Skidding:** None **Impact Point:** Front **Driver Breath Test:** Notreq **Driver Age:** 34
Veh Ref: 2 **Location:** Carw **Object in Cway:** None **From:** E **Hit and Run:** Nothtrun
Veh Type: Gdltwght **Junction:** Middle **Object off Cway:** None **To:** W **Driver Gender:** Male
Foreign Veh: **Towing;** None **velcwy:** No **J Purpose:** Work **Driver Severity:** None

Acc Ref:		Manoeuvre: Turnrigh	Skidding: None	Impact Point: Front	Driver Breath Test: Notreq	Driver Age: 21
Veh Ref:	3	Location: Carw	Object in Cway: None	From: W	Hit and Run: Nothtrun	
Veh Type:	Car	Junction: Lmain	Object off Cway: None	To: S	Driver Gender: Female	
Foreign Veh:		Towing; None	velcwy No	J Purpose: Other	Driver Severity: Slight	

Accident Details:

Acc Ref: 2019-410919649 **1st / 2nd Rd:** C56/10 C174/11 **Jun Detail:** T **Weather:** Rain **Num Cas:** 2
Day of Week: Tue **Parish:** **Jun Control:** Giveway **Light:** Darklit **Num Peds:** 0
Date: 24/12/2019 16:38:00 **District:** WelHat **Spec Conditions:** None **Road Surface:** Wet **Num Vehicles:** 2
Acc Severity: Slight **Speed Limit:** 60mph **C/way Hazard:** None **C/way Type:** Single **Ped Xing:** Npernox
C56 Dixons Hill Road North Mymms J/w C174 Swanland Road **On Site:** Yes

Both Vs Cars. V2 Trav West On Dixons Hill Road Has Collided With N/s V1 Trav East & Turning Right Into Swanland Road Across Path V2

Easting: 522604 **Northing:** 204762

Contributory Factors

Participant	Confidence	Factor 1	2	3	4	5	6
V 1	A	Flookdri		Misspeed			
V 1	B		Newdrivr				

Casualty Details

Acc Ref: 2019-410919649 **Cas Class:** Passenge **Car Passenger:** Frontsea **Cas Severity:** Slight **Ped Movement:** Notped
Veh Ref: 2 **Cas Age:** 40 **PSV Passenger:** No **Road User Class:** Car Users **Ped Location:** Notped
Cas Ref: 1 **Cas Gender:** Female **Seat Belt:** Wornind **School Pupil:** **Ped Work on Rd:** Notped

Acc Ref: 2019-410919649 **Cas Class:** Passenge **Car Passenger:** Rearseat **Cas Severity:** Slight **Ped Movement:** Notped
Veh Ref: 2 **Cas Age:** **PSV Passenger:** No **Road User Class:** Car Users **Ped Location:** Notped
Cas Ref: 2 **Cas Gender:** Female **Seat Belt:** Wornind **School Pupil:** **Ped Work on Rd:** Notped

Vehicle Details

Acc Ref: 154162 **Manoeuvre:** Turnrigh **Skidding:** None **Impact Point:** Nearside **Driver Breath Test:** Notreq **Driver Age:** 23
Veh Ref: 1 **Location:** Carw **Object in Cway:** None **From:** W **Hit and Run:** Nothtrun
Veh Type: Car **Junction:** Lmain **Object off Cway:** None **To:** S **Driver Gender:** Female
Foreign Veh: **Towing:** None **velcwy:** No **J Purpose:** Other **Driver Severity:** None

Acc Ref: **Manoeuvre:** Ahead **Skidding:** None **Impact Point:** Front **Driver Breath Test:** Notreq **Driver Age:** 40
Veh Ref: 2 **Location:** Carw **Object in Cway:** None **From:** E **Hit and Run:** Nothtrun
Veh Type: Car **Junction:** Middle **Object off Cway:** None **To:** W **Driver Gender:** Male
Foreign Veh: **Towing:** None **velcwy:** No **J Purpose:** Unknown **Driver Severity:** None

Accident Details:

Acc Ref: 2019-410916232 **1st / 2nd Rd:** C56/10 C174/11 **Jun Detail:** T **Weather:** Rain **Num Cas:** 2
Day of Week: Thu **Parish:** **Jun Control:** Giveway **Light:** Darklit **Num Peds:** 0
Date: 05/12/2019 17:25:00 **District:** WelHat **Spec Conditions:** None **Road Surface:** Wet **Num Vehicles:** 2
Acc Severity: Slight **Speed Limit:** 40mph **C/way Hazard:** None **C/way Type:** Single **Ped Xing:** Npernox
C56 Dixons Hill Road North Mymms J/w C174 Swanland Road **On Site:** Yes

Both Vs Cars. V2 Trav Sw On Dixons Hill Road Has Collided With Front V1 Trav Ne & Turning Right Into Swanland Road Across Path V2

Easting: 522601 **Northing:** 204762

Contributory Factors

Participant	Confidence	Factor 1	2	3	4	5	6
V 1	B	Slipweat	Flooddri	Misspeed	Headlite		

Casualty Details

Acc Ref: 2019-410916232 **Cas Class:** Driver **Car Passenger:** No **Cas Severity:** Slight **Ped Movement:** Notped
Veh Ref: 1 **Cas Age:** 26 **PSV Passenger:** No **Road User Class:** Car Users **Ped Location:** Notped
Cas Ref: 1 **Cas Gender:** Female **Seat Belt:** Wornnot **School Pupil:** **Ped Work on Rd:** Notped

Acc Ref: 2019-410916232 **Cas Class:** Driver **Car Passenger:** No **Cas Severity:** Slight **Ped Movement:** Notped
Veh Ref: 2 **Cas Age:** 44 **PSV Passenger:** No **Road User Class:** Car Users **Ped Location:** Notped
Cas Ref: 2 **Cas Gender:** Female **Seat Belt:** Wornnot **School Pupil:** **Ped Work on Rd:** Notped

Vehicle Details

Acc Ref: 154057 **Manoeuvre:** Turnrigh **Skidding:** None **Impact Point:** Front **Driver Breath Test:** Notreq **Driver Age:** 26
Veh Ref: 1 **Location:** Carw **Object in Cway:** None **From:** Sw **Hit and Run:** Nothtrun
Veh Type: Car **Junction:** Lmain **Object off Cway:** None **To:** Se **Driver Gender:** Female
Foreign Veh: **Towing:** None **velcwy:** No **J Purpose:** Work **Driver Severity:** Slight

Acc Ref: **Manoeuvre:** Ahead **Skidding:** None **Impact Point:** Front **Driver Breath Test:** Notreq **Driver Age:** 44
Veh Ref: 2 **Location:** Carw **Object in Cway:** None **From:** Ne **Hit and Run:** Nothtrun
Veh Type: Car **Junction:** Middle **Object off Cway:** None **To:** Sw **Driver Gender:** Female
Foreign Veh: **Towing:** None **velcwy:** No **J Purpose:** Other **Driver Severity:** Slight

Accident Details:

Acc Ref: 2019-410828999 **1st / 2nd Rd:** C56/10 C174/11 **Jun Detail:** T **Weather:** Fine **Num Cas:** 1
Day of Week: Mon **Parish:** **Jun Control:** Giveway **Light:** Day **Num Peds:** 0
Date: 04/02/2019 15:10:00 **District:** WelHat **Spec Conditions:** None **Road Surface:** Dry **Num Vehicles:** 3
Acc Severity: Slight **Speed Limit:** 60mph **C/way Hazard:** None **C/way Type:** Single **Ped Xing:** Npernox
C56 Dixons Hill Road North Mymms J/w C174 Swanland Road **On Site:** Yes

V1 Car Trav North On Swanland Road Has Turned Right Into Dixons Hill Road & Collided With O/s V3 Hgv Trav East Across Jct. This Has Caused V1 To Then Collide Head On With V2 Trav West

Easting: 522602 **Northing:** 204764

Contributory Factors

Participant	Confidence	Factor 1	2	3	4	5	6
V 1	A	Flookdri					
V 1	B		Misspeed				

Casualty Details

Acc Ref: 2019-410828999 **Cas Class:** Driver **Car Passenger:** No **Cas Severity:** Slight **Ped Movement:** Notped
Veh Ref: 2 **Cas Age:** 64 **PSV Passenger:** No **Road User Class:** Car Users **Ped Location:** Notped
Cas Ref: 1 **Cas Gender:** Female **Seat Belt:** Unknown **School Pupil:** **Ped Work on Rd:** Notped

Vehicle Details

Acc Ref: 152590 **Manoeuvre:** Turnrigh **Skidding:** None **Impact Point:** Offside **Driver Breath Test:** Negati **Driver Age:** 54
Veh Ref: 1 **Location:** Carw **Object in Cway:** None **From:** S **Hit and Run:** Nothtrun
Veh Type: Car **Junction:** Emain **Object off Cway** None **To:** E **Driver Gender:** Male
Foreign Veh: **Towing;** None **velwey** No **J Purpose:** Other **Driver Severity:** None

Acc Ref: **Manoeuvre:** Ahead **Skidding:** None **Impact Point:** Front **Driver Breath Test:** Notreq **Driver Age:** 64
Veh Ref: 2 **Location:** Carw **Object in Cway:** None **From:** E **Hit and Run:** Nothtrun
Veh Type: Car **Junction:** Middle **Object off Cway** None **To:** W **Driver Gender:** Female
Foreign Veh: **Towing;** None **velwey** No **J Purpose:** Other **Driver Severity:** Slight

Acc Ref: **Manoeuvre:** Ahead **Skidding:** None **Impact Point:** Offside **Driver Breath Test:** Notreq **Driver Age:** 52
Veh Ref: 3 **Location:** Carw **Object in Cway:** None **From:** W **Hit and Run:** Nothtrun
Veh Type: Gdhvwght **Junction:** Middle **Object off Cway** None **To:** E **Driver Gender:** Male
Foreign Veh: **Towing;** None **velwey** No **J Purpose:** Other **Driver Severity:** None

Appendix 3 – Traffic Count Data

Colney Heath ATC, Tollgate Road



Direction: Southeastbound

Direction: Northwestbound

Direction: Total Flow

Hour Beginning	Sat 26/03/2022	Sun 27/03/2022	Mon 28/03/2022	Tue 29/03/2022	Wed 30/03/2022	Thu 31/03/2022	Fri 01/04/2022	5-Day Avg	7-Day Avg
00:00	17	21	0	9	10	14	8	11	11
01:00	9	13	0	3	3	4	6	3	5
02:00	4	0	0	5	2	1	3	2	2
03:00	9	4	3	7	4	7	9	6	6
04:00	4	8	10	7	10	10	7	9	8
05:00	7	3	29	23	24	18	25	24	18
06:00	27	11	82	85	75	79	65	77	61
07:00	72	30	104	106	127	180	181	179	143
08:00	111	64	296	280	271	266	239	270	218
09:00	185	106	222	247	264	244	219	239	212
10:00	285	107	145	136	166	150	173	154	166
11:00	259	209	159	172	167	174	188	172	190
12:00	312	297	157	180	183	180	230	186	230
13:00	311	267	183	194	193	227	230	205	230
14:00	294	241	229	257	230	213	243	234	244
15:00	278	197	276	256	29	282	382	243	241
16:00	265	208	365	322	0	326	410	285	271
17:00	236	173	291	329	54	364	367	267	269
18:00	200	131	219	235	222	207	167	210	200
19:00	140	80	125	121	151	141	125	133	126
20:00	90	0	84	70	62	67	91	75	66
21:00	40	0	52	46	55	61	65	56	46
22:00	14	0	39	36	39	47	49	39	35
23:00	29	0	13	15	8	29	40	39	18
Total	2832	2030	2736	2714	2006	2801	2968	2845	2584
12M(7-19)	3129	2121	3079	3036	2349	3149	3114	2885	2882
18M(6-24)	3121	2121	3111	3087	2396	3215	3383	3042	2985
24M(0-24)	3262	2170	3173	3140	2446	3265	3447	3604	2986
AM Peak	11:00	11:00	08:00	08:00	08:00	08:00	08:00	08:00	08:00
PM Peak	13:00	12:00	16:00	17:00	14:00	17:00	16:00	16:00	16:00
360 TSL Ltd	113	297	365	329	230	304	410	301	271

Hour Beginning	Sat 26/03/2022	Sun 27/03/2022	Mon 28/03/2022	Tue 29/03/2022	Wed 30/03/2022	Thu 31/03/2022	Fri 01/04/2022	5-Day Avg	7-Day Avg
00:00	19	23	0	6	6	6	14	9	8
01:00	9	18	0	6	6	9	6	5	8
02:00	2	0	0	4	4	3	5	4	5
03:00	12	7	5	5	5	8	11	8	8
04:00	14	5	14	12	21	9	13	14	13
05:00	21	5	37	41	48	36	41	41	33
06:00	51	14	135	148	146	129	121	135	106
07:00	104	35	322	351	315	310	244	268	260
08:00	167	72	420	437	384	406	306	393	311
09:00	250	143	207	227	245	236	223	228	219
10:00	269	162	187	218	215	234	176	204	207
11:00	290	242	167	205	187	181	230	192	213
12:00	257	267	178	184	178	152	252	188	209
13:00	264	253	186	192	158	192	236	193	211
14:00	250	189	181	236	180	210	229	207	211
15:00	222	183	239	245	21	213	200	184	189
16:00	199	185	266	270	0	274	221	206	202
17:00	176	140	296	291	29	290	245	248	269
18:00	125	126	155	173	190	180	153	170	157
19:00	101	76	99	100	108	108	118	107	101
20:00	67	0	67	44	60	65	78	63	64
21:00	56	0	34	39	38	64	46	44	40
22:00	37	0	34	23	32	32	36	21	29
23:00	69	0	18	13	17	33	37	24	22
Total	2573	1997	2893	3030	2097	2868	2704	2700	2582
12M(7-19)	2968	2087	3118	3361	2449	3234	3067	3050	2883
18M(6-24)	2954	2087	3188	3397	2498	3259	3142	3105	2938
24M(0-24)	3031	2149	3244	3473	2596	3378	3227	3184	3014
AM Peak	11:00	11:00	08:00	08:00	08:00	08:00	08:00	08:00	08:00
PM Peak	13:00	12:00	17:00	17:00	18:00	17:00	17:00	17:00	17:00
360 TSL Ltd	304	367	395	391	190	290	351	330	313

Hour Beginning	Sat 26/03/2022	Sun 27/03/2022	Mon 28/03/2022	Tue 29/03/2022	Wed 30/03/2022	Thu 31/03/2022	Fri 01/04/2022	5-Day Avg	7-Day Avg
00:00	36	48	0	17	15	14	13	16	23
01:00	18	31	0	9	9	13	12	9	13
02:00	6	0	0	9	8	4	8	6	5
03:00	21	11	8	12	13	15	20	14	14
04:00	18	13	24	19	31	19	20	23	21
05:00	28	8	66	63	72	54	66	64	51
06:00	78	25	217	233	221	208	186	213	167
07:00	176	65	516	457	542	499	425	488	383
08:00	278	136	716	717	655	672	545	661	531
09:00	455	249	429	474	509	480	442	467	431
10:00	554	309	332	354	381	374	347	358	373
11:00	549	451	326	377	354	355	408	364	403
12:00	589	504	385	384	356	341	472	374	429
13:00	577	520	360	386	351	419	419	466	391
14:00	544	430	410	493	410	423	442	442	455
15:00	500	380	515	502	50	475	592	427	431
16:00	464	393	631	592	0	600	631	491	473
17:00	414	215	586	530	83	644	532	497	459
18:00	345	257	374	408	412	387	410	380	358
19:00	241	156	224	221	259	249	243	239	228
20:00	157	0	152	114	122	132	169	138	123
21:00	96	0	86	85	93	125	111	100	85
22:00	91	0	71	59	71	79	67	69	61
23:00	96	0	31	28	25	52	77	69	44
Total	5405	4027	5539	5744	4103	5669	5672	5345	5166
12M(7-19)	5977	4208	6217	6397	4788	6383	6381	6035	5796
18M(6-24)	6166	4208	6319	6484	4884	6514	6515	6147	5873
24M(0-24)	6293	4319	6417	6613	5042	6643	6674	6278	6000
AM Peak	11:00	11:00	08:00	08:00	08:00	08:00	08:00	08:00	08:00
PM Peak	13:00	12:00	16:00	17:00	18:00	17:00	16:00	16:00	16:00
360 TSL Ltd	577	564	631	620	412	644	631	601	613

Colney Heath ATC, Tollgate Road

Direction: Southeastbound

	Total Volume	LIGHT	OGV1	OGV2	BUS
Sat 26 Mar 2022	3262	2703	539	6	14
Sun 27 Mar 2022	2170	1854	308	4	4
Mon 28 Mar 2022	3173	2403	727	2	41
Tue 29 Mar 2022	3140	2495	609	3	33
Wed 30 Mar 2022	2446	1926	487	2	31
Thu 31 Mar 2022	3265	2556	665	5	39
Fri 1 Apr 2022	3447	2747	646	5	49
5 Day Ave.	3094	2425	627	3	39
7 Day Ave.	2986	2383	569	4	30

Direction: Northwestbound

	Total Volume	LIGHT	OGV1	OGV2	BUS
Sat 26 Mar 2022	3031	2782	248	0	1
Sun 27 Mar 2022	2149	2045	99	3	2
Mon 28 Mar 2022	3244	2825	400	4	15
Tue 29 Mar 2022	3473	3184	275	8	6
Wed 30 Mar 2022	2596	2330	241	8	17
Thu 31 Mar 2022	3378	3002	359	7	10
Fri 1 Apr 2022	3227	2876	338	3	10
5 Day Ave.	3184	2843	323	6	12
7 Day Ave.	3014	2721	280	5	9

Direction: Total Flow

	Total Volume	LIGHT	OGV1	OGV2	BUS
Sat 26 Mar 2022	6293	5485	787	6	15
Sun 27 Mar 2022	4319	3899	407	7	6
Mon 28 Mar 2022	6417	5228	1127	6	56
Tue 29 Mar 2022	6613	5679	884	11	39
Wed 30 Mar 2022	5042	4256	728	10	48
Thu 31 Mar 2022	6643	5558	1024	12	49
Fri 1 Apr 2022	6674	5623	984	8	59
5 Day Ave.	6278	5260	949	9	50
7 Day Ave.	6000	5104	849	9	39

	Total Volume	LIGHT	OGV1	OGV2	BUS
Sat 26 Mar 2022	100.0%	82.9%	16.5%	0.2%	0.4%
Sun 27 Mar 2022	100.0%	85.4%	14.2%	0.2%	0.2%
Mon 28 Mar 2022	100.0%	75.7%	22.9%	0.1%	1.3%
Tue 29 Mar 2022	100.0%	79.5%	19.4%	0.1%	1.1%
Wed 30 Mar 2022	100.0%	78.7%	19.9%	0.1%	1.3%
Thu 31 Mar 2022	100.0%	78.3%	20.4%	0.2%	1.2%
Fri 1 Apr 2022	100.0%	79.7%	18.7%	0.1%	1.4%
5 Day Ave.	100.0%	78.4%	20.3%	0.1%	1.2%
7 Day Ave.	100.0%	79.8%	19.0%	0.1%	1.0%

	Total Volume	LIGHT	OGV1	OGV2	BUS
Sat 26 Mar 2022	100.0%	91.8%	8.2%	0.0%	0.0%
Sun 27 Mar 2022	100.0%	95.2%	4.6%	0.1%	0.1%
Mon 28 Mar 2022	100.0%	87.1%	12.3%	0.1%	0.5%
Tue 29 Mar 2022	100.0%	91.7%	7.9%	0.2%	0.2%
Wed 30 Mar 2022	100.0%	89.8%	9.3%	0.3%	0.7%
Thu 31 Mar 2022	100.0%	88.9%	10.6%	0.2%	0.3%
Fri 1 Apr 2022	100.0%	89.1%	10.5%	0.1%	0.3%
5 Day Ave.	100.0%	89.3%	10.1%	0.2%	0.4%
7 Day Ave.	100.0%	90.3%	9.3%	0.2%	0.3%

	Total Volume	LIGHT	OGV1	OGV2	BUS
Sat 26 Mar 2022	100.0%	87.2%	12.5%	0.1%	0.2%
Sun 27 Mar 2022	100.0%	90.3%	9.4%	0.2%	0.1%
Mon 28 Mar 2022	100.0%	81.5%	17.6%	0.1%	0.9%
Tue 29 Mar 2022	100.0%	85.9%	13.4%	0.2%	0.6%
Wed 30 Mar 2022	100.0%	84.4%	14.4%	0.2%	1.0%
Thu 31 Mar 2022	100.0%	83.7%	15.4%	0.2%	0.7%
Fri 1 Apr 2022	100.0%	84.3%	14.7%	0.1%	0.9%
5 Day Ave.	100.0%	83.9%	15.1%	0.1%	0.8%
7 Day Ave.	100.0%	85.1%	14.1%	0.1%	0.6%

360 TSL Ltd

360 TSL Ltd

360 TSL Ltd

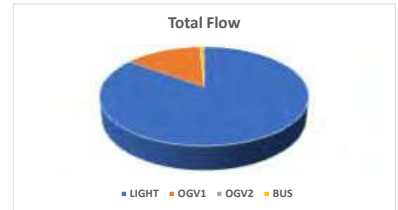
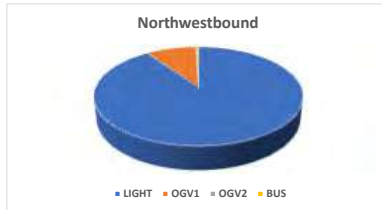
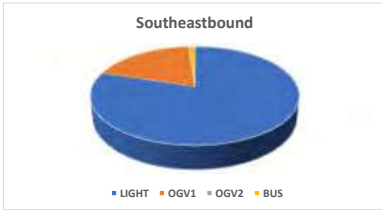

Colney Heath ATC, Tollgate Road

Direction: Southeastbound

	Total Volume	85th Percentile	Mean Average	Standard Deviation	Bin 1 <10mph	Bin 2 10<15	Bin 3 15<20	Bin 4 20<25	Bin 5 25<30	Bin 6 30<35	Bin 7 35<40	Bin 8 40<45	Bin 9 45<50	Bin 10 50<55	Bin 11 55<60	Bin 12 >=60
Sat 26 Mar 2022	3262	37.4	29.1	8.0	51	107	203	467	1020	745	420	172	55	9	5	4
Sun 27 Mar 2022	2170	38.1	30.2	7.6	19	54	91	270	647	580	321	122	47	17	1	1
Mon 28 Mar 2022	3173	38.5	30.2	8.0	37	65	179	500	752	801	531	222	57	22	6	1
Tue 29 Mar 2022	3140	38.6	30.5	7.8	42	58	100	403	920	837	503	176	55	24	16	6
Wed 30 Mar 2022	2446	38.3	30.1	8.0	40	64	116	281	673	758	311	129	44	16	7	7
Thu 31 Mar 2022	3265	38.0	29.8	7.9	55	69	163	505	834	881	485	193	55	18	4	3
Fri 1 Apr 2022	3447	38.4	29.9	8.2	59	118	174	438	885	847	502	232	59	29	2	2
5 Day Ave.	3054	38.4	30.1	8.0	47	75	146	425	813	845	466	180	54	22	7	4
7 Day Ave.	2986	38.2	30.0	7.9	43	76	147	409	819	793	439	178	53	19	6	3

360 TSI Ltd

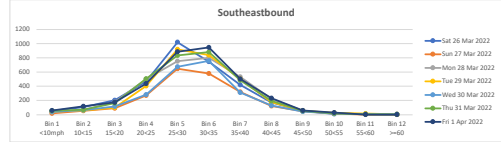

Direction: Northwestbound

	Total Volume	85th Percentile	Mean Average	Standard Deviation	Bin 1 <10mph	Bin 2 10<15	Bin 3 15<20	Bin 4 20<25	Bin 5 25<30	Bin 6 30<35	Bin 7 35<40	Bin 8 40<45	Bin 9 45<50	Bin 10 50<55	Bin 11 55<60	Bin 12 >=60
Sat 26 Mar 2022	3031	36.4	29.5	6.6	22	62	145	333	1031	952	351	94	30	6	5	0
Sun 27 Mar 2022	2149	36.8	30.2	6.3	8	28	79	213	698	728	288	79	19	6	1	2
Mon 28 Mar 2022	3244	36.5	30.6	5.7	12	21	61	283	1112	1192	423	105	26	5	3	1
Tue 29 Mar 2022	3473	35.7	29.6	5.9	20	48	100	365	1283	1200	344	82	23	6	2	0
Wed 30 Mar 2022	2596	35.5	29.2	6.1	15	47	78	354	970	786	263	61	16	5	1	0
Thu 31 Mar 2022	3378	35.7	29.7	5.8	15	28	88	400	1264	1094	375	83	22	7	1	1
Fri 1 Apr 2022	3227	36.5	30.1	6.1	13	45	92	329	1083	1127	395	110	26	8	2	1
5 Day Ave.	3184	36.0	29.9	5.9	15	38	84	346	1142	1080	359	88	23	6	2	1
7 Day Ave.	3014	36.2	29.9	6.1	15	40	92	325	1063	1011	348	88	23	6	2	1

360 TSI Ltd

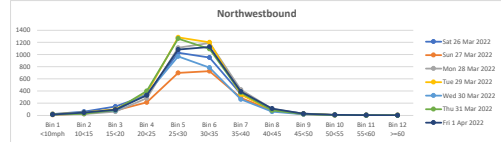

Direction: Total Flow

	Total Volume	85th Percentile	Mean Average	Standard Deviation	Bin 1 <10mph	Bin 2 10<15	Bin 3 15<20	Bin 4 20<25	Bin 5 25<30	Bin 6 30<35	Bin 7 35<40	Bin 8 40<45	Bin 9 45<50	Bin 10 50<55	Bin 11 55<60	Bin 12 >=60
Sat 26 Mar 2022	6293	36.9	29.3	7.4	73	169	348	800	2051	1697	771	266	85	15	14	4
Sun 27 Mar 2022	4319	37.5	30.2	7.0	27	82	170	483	1345	1308	609	201	66	23	2	3
Mon 28 Mar 2022	6417	37.6	30.4	6.9	49	86	240	783	1864	1993	564	327	83	27	9	2
Tue 29 Mar 2022	6613	37.2	30.1	6.9	62	106	200	768	2203	2037	847	258	78	30	18	6
Wed 30 Mar 2022	5042	36.9	29.6	7.1	55	111	194	635	1643	1544	574	190	60	21	8	7
Thu 31 Mar 2022	6643	36.9	29.8	6.9	70	97	251	905	2098	1975	860	276	77	25	5	4
Fri 1 Apr 2022	6674	37.5	30.0	7.2	72	163	266	767	1968	2074	893	342	85	37	4	3
5 Day Ave.	6278	37.2	30.0	7.0	62	113	230	772	1955	1925	826	279	77	28	9	4
7 Day Ave.	6000	37.2	29.9	7.0	58	116	238	734	1882	1804	787	266	76	25	9	4

360 TSI Ltd

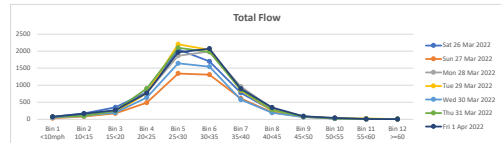

Colney Heath, Tuesday 29th March 2022

Junction: 1
 Approach: A414 North Orbital Road East



Queues Measured as Stationary Vehicles (Maximum Queue every 5 Minutes)

TIME	Left to High Street				Aged to A414 North Orbital Road (West)					
	LIGHT	HEAVY	BUS	TOTAL	PCUs	LIGHT	HEAVY	BUS	TOTAL	PCUs
07:00 - 07:15	45	2	0	47	49.6	401	26	0	427	460.8
07:15 - 07:30	70	0	0	70	70.0	449	36	0	485	531.8
07:30 - 07:45	58	1	1	60	62.3	470	24	2	496	529.2
07:45 - 08:00	78	0	0	78	78.0	415	31	0	446	486.3
Hourly Total	251	3	1	255	259.9	1735	117	2	1854	2008.1
08:00 - 08:15	75	5	0	80	86.5	387	29	1	417	455.7
08:15 - 08:30	95	1	6	102	109.3	391	28	2	421	459.4
08:30 - 08:45	83	1	0	84	85.3	382	46	0	428	487.8
08:45 - 09:00	88	2	0	90	92.6	341	35	0	376	421.5
Hourly Total	341	9	6	356	373.7	1501	138	3	1642	1824.4
09:00 - 09:15	63	1	1	65	67.3	290	46	1	337	397.8
09:15 - 09:30	52	2	1	55	58.6	337	41	1	379	433.3
09:30 - 09:45	51	1	1	53	55.3	354	43	1	398	454.9
09:45 - 10:00	44	1	0	45	46.3	346	48	0	394	456.4
Hourly Total	210	5	3	218	227.5	1327	178	3	1508	1742.4

TOTAL	802	17	10	829	861.1	4563	433	8	5004	5574.9
--------------	------------	-----------	-----------	------------	--------------	-------------	------------	----------	-------------	---------------

16:00 - 16:15	98	0	0	98	98.0	353	18	1	372	396.4
16:15 - 16:30	110	0	2	112	114.0	413	24	0	437	468.2
16:30 - 16:45	102	1	0	103	104.3	382	14	1	397	416.2
16:45 - 17:00	97	1	0	98	99.3	415	13	0	428	444.9
Hourly Total	407	2	2	411	415.6	1563	69	2	1634	1725.7
17:00 - 17:15	78	0	1	79	80.0	456	13	0	469	485.9
17:15 - 17:30	81	0	0	81	81.0	458	20	0	478	504.0
17:30 - 17:45	111	0	0	111	111.0	430	12	0	442	457.6
17:45 - 18:00	91	0	1	92	93.0	419	12	0	431	446.6
Hourly Total	361	0	2	363	365.0	1763	57	0	1820	1894.1
18:00 - 18:15	57	0	0	57	57.0	371	16	0	387	407.8
18:15 - 18:30	59	1	1	61	63.3	406	14	1	421	440.2
18:30 - 18:45	68	0	0	68	68.0	334	17	1	352	375.1
18:45 - 19:00	46	0	0	46	46.0	320	11	0	331	345.3
Hourly Total	230	1	1	232	234.3	1431	58	2	1491	1568.4

TOTAL	998	3	5	1006	1014.9	4757	184	4	4945	5188.2
--------------	------------	----------	----------	-------------	---------------	-------------	------------	----------	-------------	---------------

PCU Factors:	
LIGHT	1.0
HEAVY	2.3
BUS	2.0

TIME	Queue Lengths (Vehicles)
700	8
705	8
710	9
715	5
720	10
725	9
730	12
735	10
740	8
745	10
750	10
755	10
800	7
805	9
810	9
815	8
820	11
825	10
830	9
835	9
840	9
845	9
850	12
855	10
900	12
905	14
910	14
915	13
920	13
925	8
930	12
935	10
940	12
945	13
950	15
955	12

TIME	Queue Lengths (Vehicles)
1600	8
1605	9
1610	10
1615	9
1620	11
1625	10
1630	13
1635	12
1640	10
1645	10
1650	9
1655	10
1700	8
1705	8
1710	9
1715	10
1720	12
1725	9
1730	12
1735	12
1740	10
1745	7
1750	7
1755	7
1800	8
1805	10
1810	12
1815	10
1820	11
1825	9
1830	6
1835	11
1840	14
1845	9
1850	9
1855	7

Colney Heath, Tuesday 29th March 2022

Junction: 1
Approach: High Street



Queues Measured as Stationary Vehicles (Maximum Queue every 5 Minutes)

TIME	Left to A414 North Orbital Road (West)					Right to A414 North Orbital Road (East)				
	LIGHT	HEAVY	BUS	TOTAL	PCUs	LIGHT	HEAVY	BUS	TOTAL	PCUs
07:00 - 07:15	22	1	0	23	24.3	25	0	0	25	25.0
07:15 - 07:30	32	0	0	32	32.0	33	0	0	33	33.0
07:30 - 07:45	45	0	0	45	45.0	53	1	0	54	55.3
07:45 - 08:00	58	0	0	58	58.0	54	0	0	54	54.0
Hourly Total	157	1	0	158	159.3	165	1	0	166	167.3
08:00 - 08:15	80	0	2	82	84.0	66	1	0	67	68.3
08:15 - 08:30	67	2	0	69	71.6	71	2	0	73	75.6
08:30 - 08:45	55	0	0	55	55.0	59	2	0	61	63.6
08:45 - 09:00	49	1	0	50	51.3	54	2	0	56	58.6
Hourly Total	251	3	2	256	261.9	250	7	0	257	266.1
09:00 - 09:15	39	2	0	41	43.6	52	2	0	54	56.6
09:15 - 09:30	31	2	0	33	35.6	43	0	0	43	43.0
09:30 - 09:45	25	1	0	26	27.3	24	0	0	24	24.0
09:45 - 10:00	25	1	0	26	27.3	28	0	0	28	28.0
Hourly Total	120	6	0	126	133.8	147	2	0	149	151.6
TOTAL	528	10	2	540	555.0	562	10	0	572	585.0

16:00 - 16:15	35	1	0	36	37.3	41	2	0	43	45.6
16:15 - 16:30	35	0	0	35	35.0	65	1	0	66	67.3
16:30 - 16:45	28	2	0	30	32.6	66	0	0	66	66.0
16:45 - 17:00	31	0	0	31	31.0	67	0	1	68	69.0
Hourly Total	129	3	0	132	135.9	239	3	1	243	247.9
17:00 - 17:15	43	1	0	44	45.3	73	1	0	74	75.3
17:15 - 17:30	34	1	1	36	38.3	77	2	0	79	81.6
17:30 - 17:45	37	0	0	37	37.0	63	0	0	63	63.0
17:45 - 18:00	27	0	0	27	27.0	68	0	0	68	68.0
Hourly Total	141	2	1	144	147.6	281	3	0	284	287.9
18:00 - 18:15	15	0	0	15	15.0	72	0	0	72	72.0
18:15 - 18:30	28	0	0	28	28.0	46	1	0	47	48.3
18:30 - 18:45	25	0	0	25	25.0	44	0	0	44	44.0
18:45 - 19:00	23	0	0	23	23.0	44	0	0	44	44.0
Hourly Total	91	0	0	91	91.0	206	1	0	207	208.3
TOTAL	361	5	1	367	374.5	726	7	1	734	744.1

PCU Factors:	
LIGHT	1.0
HEAVY	2.3
BUS	2.0

TIME	Queue Lengths (Vehicles)
700	6
705	8
710	7
715	9
720	10
725	12
730	12
735	12
740	13
745	15
750	13
755	18
800	17
805	17
810	14
815	17
820	14
825	16
830	15
835	15
840	15
845	12
850	15
855	14
900	14
905	18
910	13
915	14
920	12
925	9
930	4
935	5
940	5
945	4
950	8
955	4

TIME	Queue Lengths (Vehicles)
1600	3
1605	5
1610	5
1615	6
1620	4
1625	11
1630	10
1635	14
1640	12
1645	7
1650	7
1655	11
1700	14
1705	15
1710	13
1715	13
1720	13
1725	10
1730	12
1735	12
1740	9
1745	13
1750	12
1755	14
1800	10
1805	13
1810	9
1815	9
1820	11
1825	8
1830	5
1835	6
1840	6
1845	5
1850	5
1855	5

Colney Heath, Tuesday 29th March 2022

Junction: 1
 Approach: A414 North Orbital Road West



Queues Measured as Stationary Vehicles (Maximum Queue every 5 Minutes)

TIME	Ahead to A414 North Orbital Road (East)					Right to High Street				
	LIGHT	HEAVY	BUS	TOTAL	PCUs	LIGHT	HEAVY	BUS	TOTAL	PCUs
07:00 - 07:15	319	34	0	353	397.2	0	0	0	0	0.0
07:15 - 07:30	305	32	1	338	380.6	0	0	0	0	0.0
07:30 - 07:45	340	29	0	369	406.7	0	0	0	0	0.0
07:45 - 08:00	311	21	0	332	359.3	0	0	0	0	0.0
Hourly Total	1275	116	1	1392	1543.8	0	0	0	0	0.0
08:00 - 08:15	303	29	0	332	369.7	0	0	0	0	0.0
08:15 - 08:30	370	24	5	399	435.2	0	0	0	0	0.0
08:30 - 08:45	361	21	1	399	434.3	0	0	0	0	0.0
08:45 - 09:00	358	32	0	400	441.6	0	0	0	0	0.0
Hourly Total	1402	116	6	1524	1680.8	0	0	0	0	0.0
09:00 - 09:15	315	36	1	352	399.8	0	0	0	0	0.0
09:15 - 09:30	298	43	1	342	398.9	0	0	0	0	0.0
09:30 - 09:45	288	30	2	320	361.0	0	0	0	0	0.0
09:45 - 10:00	346	45	0	391	449.5	0	0	0	0	0.0
Hourly Total	1247	154	4	1405	1609.2	0	0	0	0	0.0
TOTAL	3924	386	11	4321	4833.8	0	0	0	0	0.0

TOTAL	3924	386	11	4321	4833.8	0	0	0	0	0.0
--------------	-------------	------------	-----------	-------------	---------------	----------	----------	----------	----------	------------

16:00 - 16:15	275	23	0	298	327.9	0	0	0	0	0.0
16:15 - 16:30	300	11	0	311	325.3	0	0	0	0	0.0
16:30 - 16:45	325	20	0	345	371.0	0	0	0	0	0.0
16:45 - 17:00	290	14	2	306	326.2	0	0	0	0	0.0
Hourly Total	1190	68	2	1260	1350.4	0	0	0	0	0.0
17:00 - 17:15	338	28	1	367	404.4	0	0	0	0	0.0
17:15 - 17:30	335	23	0	358	387.9	0	0	0	0	0.0
17:30 - 17:45	361	21	1	383	411.3	0	0	0	0	0.0
17:45 - 18:00	350	11	0	361	375.3	0	0	0	0	0.0
Hourly Total	1384	83	2	1469	1578.9	0	0	0	0	0.0
18:00 - 18:15	391	21	2	414	443.3	0	0	0	0	0.0
18:15 - 18:30	332	18	1	351	375.4	0	0	0	0	0.0
18:30 - 18:45	353	13	2	368	386.9	0	0	0	0	0.0
18:45 - 19:00	270	18	1	289	313.4	0	0	0	0	0.0
Hourly Total	1346	70	6	1422	1519.0	0	0	0	0	0.0
TOTAL	3920	221	10	4151	4448.3	0	0	0	0	0.0

PCU Factors:	
LIGHT	1.0
HEAVY	2.3
BUS	2.0

TIME	Queue Lengths (Vehicles)
700	6
705	5
710	7
715	8
720	8
725	9
730	11
735	14
740	12
745	10
750	12
755	12
800	10
805	10
810	11
815	8
820	9
825	9
830	5
835	9
840	7
845	10
850	8
855	10
900	12
905	13
910	10
915	12
920	12
925	12
930	12
935	16
940	12
945	10
950	10
955	8

TIME	Queue Lengths (Vehicles)
1600	10
1605	10
1610	12
1615	13
1620	15
1625	13
1630	12
1635	12
1640	11
1645	15
1650	16
1655	19
1700	15
1705	11
1710	13
1715	14
1720	14
1725	12
1730	14
1735	16
1740	17
1745	14
1750	14
1755	12
1800	12
1805	9
1810	12
1815	10
1820	10
1825	11
1830	15
1835	12
1840	9
1845	10
1850	12
1855	11

Colney Heath, Tuesday 29th March 2022

Junction: 2
 Approach: Roestock Lane



Queues Measured as Stationary Vehicles (Maximum Queue every 5 Minutes)

TIME	Left to Tollgate Road				Ahead to Coursers Road				Right to High Street						
	LIGHT	HEAVY	BUS	TOTAL	PCUs	LIGHT	HEAVY	BUS	TOTAL	PCUs	LIGHT	HEAVY	BUS	TOTAL	PCUs
07:00 - 07:15	0	0	0	0	0.0	9	0	0	9	9.0	3	0	0	3	3.0
07:15 - 07:30	1	0	0	1	1.0	8	0	0	8	8.0	9	0	0	9	9.0
07:30 - 07:45	2	0	0	2	2.0	8	0	0	8	8.0	14	0	0	14	14.0
07:45 - 08:00	3	0	0	3	3.0	12	0	0	12	12.0	16	0	0	16	16.0
Hourly Total	6	0	0	6	6.0	37	0	0	37	37.0	42	0	0	42	42.0
08:00 - 08:15	1	1	0	2	3.3	7	0	0	7	7.0	29	0	0	29	29.0
08:15 - 08:30	1	0	0	1	1.0	4	0	0	4	4.0	16	2	0	18	20.6
08:30 - 08:45	1	0	0	1	1.0	2	0	0	2	2.0	17	0	0	17	17.0
08:45 - 09:00	3	0	0	3	3.0	4	0	0	4	4.0	23	0	0	23	23.0
Hourly Total	6	1	0	7	8.3	17	0	0	17	17.0	85	2	0	87	89.6
09:00 - 09:15	2	0	0	2	2.0	8	0	0	8	8.0	9	0	0	9	9.0
09:15 - 09:30	4	0	0	4	4.0	5	0	0	5	5.0	11	0	0	11	11.0
09:30 - 09:45	4	0	0	4	4.0	6	0	0	6	6.0	10	1	0	11	12.3
09:45 - 10:00	2	0	0	2	2.0	3	0	0	3	3.0	4	0	0	4	4.0
Hourly Total	12	0	0	12	12.0	22	0	0	22	22.0	34	1	0	35	36.3
TOTAL	24	1	0	25	26.3	76	0	0	76	76.0	161	3	0	164	167.9
16:00 - 16:15	0	0	0	0	0.0	5	0	0	5	5.0	6	0	0	6	6.0
16:15 - 16:30	0	0	0	0	0.0	3	0	0	3	3.0	13	0	0	13	13.0
16:30 - 16:45	2	0	0	2	2.0	2	0	0	2	2.0	8	1	0	9	10.3
16:45 - 17:00	0	0	0	0	0.0	1	0	0	1	1.0	13	0	0	13	13.0
Hourly Total	2	0	0	2	2.0	11	0	0	11	11.0	40	1	0	41	42.3
17:00 - 17:15	0	0	0	0	0.0	7	0	0	7	7.0	11	0	0	11	11.0
17:15 - 17:30	2	0	0	2	2.0	3	0	0	3	3.0	8	0	0	8	8.0
17:30 - 17:45	1	0	0	1	1.0	3	0	0	3	3.0	16	0	0	16	16.0
17:45 - 18:00	4	0	0	4	4.0	5	0	0	5	5.0	5	0	0	5	5.0
Hourly Total	7	0	0	7	7.0	18	0	0	18	18.0	40	0	0	40	40.0
18:00 - 18:15	1	0	0	1	1.0	3	0	0	3	3.0	4	0	0	4	4.0
18:15 - 18:30	0	0	0	0	0.0	4	0	0	4	4.0	5	0	0	5	5.0
18:30 - 18:45	0	0	0	0	0.0	4	0	0	4	4.0	13	0	0	13	13.0
18:45 - 19:00	0	0	0	0	0.0	1	0	0	1	1.0	6	0	0	6	6.0
Hourly Total	1	0	0	1	1.0	12	0	0	12	12.0	28	0	0	28	28.0
TOTAL	10	0	0	10	10.0	41	0	0	41	41.0	108	1	0	109	110.3

PCU Factors:	
LIGHT	1.0
HEAVY	2.3
BUS	2.0

TIME	Queue Lengths (Vehicles)
700	0
705	0
710	2
715	0
720	0
725	2
730	0
735	0
740	0
745	3
750	4
755	3
800	0
805	2
810	0
815	2
820	2
825	3
830	0
835	3
840	3
845	0
850	0
855	2
900	0
905	0
910	2
915	2
920	0
925	2
930	0
935	0
940	0
945	2
950	0
955	0

TIME	Queue Lengths (Vehicles)
1600	0
1605	2
1610	0
1615	0
1620	0
1625	0
1630	0
1635	0
1640	0
1645	0
1650	0
1655	3
1700	2
1705	0
1710	0
1715	2
1720	0
1725	0
1730	0
1735	0
1740	3
1745	0
1750	2
1755	0
1800	0
1805	0
1810	0
1815	0
1820	0
1825	0
1830	0
1835	0
1840	0
1845	0
1850	0
1855	0

Colney Heath, Tuesday 29th March 2022

Junction: 2
 Approach: Tollgate Road

TIME	Left to Coursers Road					Ahead	
	LIGHT	HEAVY	BUS	TOTAL	PCUs	LIGHT	HEAVY
07:00 - 07:15	26	1	0	27	28.3	41	0
07:15 - 07:30	51	1	0	52	53.3	35	0
07:30 - 07:45	54	1	0	55	56.3	52	1
07:45 - 08:00	50	1	0	51	52.3	55	0
Hourly Total	181	4	0	185	190.2	183	1
08:00 - 08:15	66	0	0	66	66.0	84	1
08:15 - 08:30	49	1	0	50	51.3	51	0
08:30 - 08:45	44	2	0	46	48.6	62	1
08:45 - 09:00	41	0	0	41	41.0	58	0
Hourly Total	200	3	0	203	206.9	255	2
09:00 - 09:15	30	1	0	31	32.3	34	3
09:15 - 09:30	29	3	1	33	37.9	32	1
09:30 - 09:45	21	1	0	22	23.3	25	0
09:45 - 10:00	17	0	0	17	17.0	36	0
Hourly Total	97	5	1	103	110.5	127	4

TOTAL	478	12	1	491	507.6	565	7
--------------	------------	-----------	----------	------------	--------------	------------	----------

16:00 - 16:15	43	0	0	43	43.0	46	1
16:15 - 16:30	24	0	0	24	24.0	40	0
16:30 - 16:45	36	0	0	36	36.0	36	1
16:45 - 17:00	26	2	0	28	30.6	28	0
Hourly Total	129	2	0	131	133.6	150	2
17:00 - 17:15	45	0	0	45	45.0	56	1
17:15 - 17:30	40	0	0	40	40.0	35	1
17:30 - 17:45	38	0	0	38	38.0	28	0
17:45 - 18:00	31	0	0	31	31.0	23	0
Hourly Total	154	0	0	154	154.0	142	2
18:00 - 18:15	16	0	0	16	16.0	25	0
18:15 - 18:30	14	0	0	14	14.0	35	0
18:30 - 18:45	22	0	0	22	22.0	24	0
18:45 - 19:00	16	0	0	16	16.0	26	0
Hourly Total	68	0	0	68	68.0	110	0

TOTAL	351	2	0	353	355.6	402	4
--------------	------------	----------	----------	------------	--------------	------------	----------

Left to High Street			Right to Roestock Lane					
BUS	TOTAL	PCUs	LIGHT	HEAVY	BUS	TOTAL	PCUs	LIGHT
0	41	41.0	0	0	0	0	0.0	0
0	35	35.0	0	0	0	0	0.0	0
0	53	54.3	1	0	0	1	1.0	0
0	55	55.0	0	0	0	0	0.0	0
0	184	185.3	1	0	0	1	1.0	0
2	87	90.3	0	0	0	0	0.0	0
0	51	51.0	1	0	0	1	1.0	0
0	63	64.3	0	0	0	0	0.0	0
0	58	58.0	0	0	0	0	0.0	0
2	259	263.6	1	0	0	1	1.0	0
0	37	40.9	1	0	0	1	1.0	0
0	33	34.3	2	0	0	2	2.0	0
0	25	25.0	1	0	0	1	1.0	1
0	36	36.0	0	0	0	0	0.0	0
0	131	136.2	4	0	0	4	4.0	1

2	574	585.1	6	0	0	6	6.0	1
---	-----	-------	---	---	---	---	-----	---

0	47	48.3	2	0	0	2	2.0	0
0	40	40.0	1	0	0	1	1.0	0
1	38	40.3	0	0	0	0	0.0	0
0	28	28.0	0	0	0	0	0.0	0
1	153	156.6	3	0	0	3	3.0	0
0	57	58.3	1	0	0	1	1.0	0
1	37	39.3	0	0	0	0	0.0	0
0	28	28.0	4	0	0	4	4.0	0
0	23	23.0	1	0	0	1	1.0	1
1	145	148.6	6	0	0	6	6.0	1
0	25	25.0	3	0	0	3	3.0	0
0	35	35.0	1	0	0	1	1.0	0
0	24	24.0	1	0	0	1	1.0	0
0	26	26.0	1	0	0	1	1.0	0
0	110	110.0	6	0	0	6	6.0	0

2	408	415.2	15	0	0	15	15.0	1
---	-----	-------	----	---	---	----	------	---

Measured as Stationary Vehicles (Maximum Queue every 5 Minutes)

Queue Lengths (Vehicles)
2
0
4
3
2
3
5
4
3
3
6
5
2
3
3
6
4
3
7
7
6
6
2
3
3
4
0
2
3
4
5
2
3
3
4
4

TIME	Queue Lengths (Vehicles)
1600	2
1605	0
1610	3
1615	3
1620	2
1625	3
1630	3
1635	2
1640	4
1645	3
1650	0
1655	3
1700	4
1705	5
1710	3
1715	2
1720	6
1725	0
1730	2
1735	3
1740	3
1745	4
1750	3
1755	2
1800	3
1805	4
1810	5
1815	3
1820	3
1825	3
1830	4
1835	3
1840	3
1845	4
1850	3
1855	3

Colney Heath, Tuesday 29th March 2022

Junction: 2

Approach: Coursers Road

TIME	Left to High Street					Ahead	
	LIGHT	HEAVY	BUS	TOTAL	PCUs	LIGHT	HEAVY
07:00 - 07:15	15	0	0	15	15.0	1	0
07:15 - 07:30	21	0	0	21	21.0	1	0
07:30 - 07:45	25	1	0	26	27.3	0	0
07:45 - 08:00	34	0	0	34	34.0	5	0
Hourly Total	95	1	0	96	97.3	7	0
08:00 - 08:15	35	1	0	36	37.3	4	0
08:15 - 08:30	57	2	0	59	61.6	2	0
08:30 - 08:45	44	2	0	46	48.6	2	0
08:45 - 09:00	35	3	0	38	41.9	6	1
Hourly Total	171	8	0	179	189.4	14	1
09:00 - 09:15	24	1	0	25	26.3	2	1
09:15 - 09:30	19	0	0	19	19.0	1	1
09:30 - 09:45	11	0	0	11	11.0	3	0
09:45 - 10:00	12	0	0	12	12.0	7	0
Hourly Total	66	1	0	67	68.3	13	2

TOTAL	332	10	0	342	355.0	34	3
--------------	------------	-----------	----------	------------	--------------	-----------	----------

16:00 - 16:15	25	2	0	27	29.6	6	0
16:15 - 16:30	48	1	0	49	50.3	9	0
16:30 - 16:45	49	0	0	49	49.0	6	0
16:45 - 17:00	52	0	0	52	52.0	10	0
Hourly Total	174	3	0	177	180.9	31	0
17:00 - 17:15	54	0	0	54	54.0	5	0
17:15 - 17:30	64	2	0	66	68.6	3	0
17:30 - 17:45	60	0	0	60	60.0	6	0
17:45 - 18:00	67	0	0	67	67.0	6	0
Hourly Total	245	2	0	247	249.6	20	0
18:00 - 18:15	63	1	0	64	65.3	5	0
18:15 - 18:30	39	0	0	39	39.0	11	0
18:30 - 18:45	26	0	0	26	26.0	10	0
18:45 - 19:00	39	0	0	39	39.0	7	0
Hourly Total	167	1	0	168	169.3	33	0

TOTAL	586	6	0	592	599.8	84	0
--------------	------------	----------	----------	------------	--------------	-----------	----------

to Roestock Lane			Right to Tollgate Road					
BUS	TOTAL	PCUs	LIGHT	HEAVY	BUS	TOTAL	PCUs	LIGHT
0	1	1.0	20	0	0	20	20.0	0
0	1	1.0	27	0	0	27	27.0	0
0	0	0.0	26	2	0	28	30.6	0
0	5	5.0	41	0	1	42	43.0	0
0	7	7.0	114	2	1	117	120.6	0
0	4	4.0	20	0	0	20	20.0	0
0	2	2.0	35	0	0	35	35.0	0
0	2	2.0	33	0	0	33	33.0	0
0	7	8.3	35	1	0	36	37.3	1
0	15	16.3	123	1	0	124	125.3	1
0	3	4.3	35	0	0	35	35.0	0
0	2	3.3	29	1	0	30	31.3	0
0	3	3.0	21	0	0	21	21.0	0
0	7	7.0	24	2	0	26	28.6	2
0	15	17.6	109	3	0	112	115.9	2

0	37	40.9	346	6	1	353	361.8	3
---	----	------	-----	---	---	-----	-------	---

0	6	6.0	52	0	0	52	52.0	0
0	9	9.0	51	2	0	53	55.6	0
0	6	6.0	35	0	0	35	35.0	0
0	10	10.0	55	0	0	55	55.0	0
0	31	31.0	193	2	0	195	197.6	0
0	5	5.0	44	0	0	44	44.0	0
0	3	3.0	47	1	0	48	49.3	0
0	6	6.0	44	0	0	44	44.0	0
0	6	6.0	46	0	0	46	46.0	0
0	20	20.0	181	1	0	182	183.3	0
0	5	5.0	44	1	0	45	46.3	0
0	11	11.0	33	0	0	33	33.0	0
0	10	10.0	32	0	0	32	32.0	0
0	7	7.0	25	1	0	26	27.3	0
0	33	33.0	134	2	0	136	138.6	0

0	84	84.0	508	5	0	513	519.5	0
---	----	------	-----	---	---	-----	-------	---

Measured as Stationary Vehicles (Maximum Queue every 5 Minutes)

Queue Lengths (Vehicles)
4
3
3
2
5
4
3
3
4
3
5
3
3
3
2
4
3
3
3
4
2
2
2
3
4
2
2
3
2
3
0
3
3
2
2
2

TIME	Queue Lengths (Vehicles)
1600	2
1605	3
1610	3
1615	4
1620	3
1625	3
1630	3
1635	5
1640	4
1645	6
1650	5
1655	2
1700	4
1705	5
1710	4
1715	4
1720	5
1725	6
1730	4
1735	0
1740	6
1745	6
1750	5
1755	6
1800	7
1805	3
1810	0
1815	3
1820	3
1825	4
1830	3
1835	0
1840	4
1845	5
1850	3
1855	3

Colney Heath, Tuesday 29th March 2022

Junction: 2
Approach: High Street

TIME	Left to Roestock Lane					Ahead	
	LIGHT	HEAVY	BUS	TOTAL	PCUs	LIGHT	HEAVY
07:00 - 07:15	1	0	0	1	1.0	22	0
07:15 - 07:30	5	0	0	5	5.0	18	0
07:30 - 07:45	6	0	0	6	6.0	24	0
07:45 - 08:00	8	0	0	8	8.0	32	0
Hourly Total	20	0	0	20	20.0	96	0
08:00 - 08:15	6	2	0	8	10.6	33	0
08:15 - 08:30	11	0	0	11	11.0	40	2
08:30 - 08:45	8	0	0	8	8.0	36	0
08:45 - 09:00	8	0	0	8	8.0	42	0
Hourly Total	33	2	0	35	37.6	151	2
09:00 - 09:15	17	0	0	17	17.0	54	0
09:15 - 09:30	8	0	0	8	8.0	31	2
09:30 - 09:45	4	0	0	4	4.0	31	1
09:45 - 10:00	6	0	0	6	6.0	17	0
Hourly Total	35	0	0	35	35.0	133	3

TOTAL	88	2	0	90	92.6	380	5
--------------	-----------	----------	----------	-----------	-------------	------------	----------

16:00 - 16:15	16	0	0	16	16.0	40	0
16:15 - 16:30	8	0	0	8	8.0	37	0
16:30 - 16:45	20	0	0	20	20.0	33	0
16:45 - 17:00	15	0	0	15	15.0	41	1
Hourly Total	59	0	0	59	59.0	151	1
17:00 - 17:15	15	0	0	15	15.0	47	0
17:15 - 17:30	7	1	0	8	9.3	28	0
17:30 - 17:45	14	0	0	14	14.0	44	0
17:45 - 18:00	13	0	0	13	13.0	46	0
Hourly Total	49	1	0	50	51.3	165	0
18:00 - 18:15	12	1	0	13	14.3	35	0
18:15 - 18:30	9	0	0	9	9.0	30	0
18:30 - 18:45	20	0	0	20	20.0	29	0
18:45 - 19:00	3	0	0	3	3.0	19	0
Hourly Total	44	1	0	45	46.3	113	0

TOTAL	152	2	0	154	156.6	429	1
--------------	------------	----------	----------	------------	--------------	------------	----------

to Tollgate Road			Right to Coursers Road					
BUS	TOTAL	PCUs	LIGHT	HEAVY	BUS	TOTAL	PCUs	LIGHT
0	22	22.0	27	2	0	29	31.6	0
0	18	18.0	35	1	0	36	37.3	0
0	24	24.0	25	1	0	26	27.3	0
1	33	34.0	27	0	0	27	27.0	0
1	97	98.0	114	4	0	118	123.2	0
0	33	33.0	34	1	0	35	36.3	1
5	47	54.6	24	1	0	25	26.3	0
1	37	38.0	37	1	0	38	39.3	0
0	42	42.0	27	2	0	29	31.6	0
6	159	167.6	122	5	0	127	133.5	1
0	54	54.0	27	0	0	27	27.0	1
0	33	35.6	18	0	1	19	20.0	1
0	32	33.3	15	0	0	15	15.0	0
0	17	17.0	24	0	0	24	24.0	0
0	136	139.9	84	0	1	85	86.0	2

7	392	405.5	320	9	1	330	342.7	3
---	-----	-------	-----	---	---	-----	-------	---

0	40	40.0	41	0	0	41	41.0	0
1	38	39.0	66	0	0	66	66.0	0
1	34	35.0	57	1	0	58	59.3	2
0	42	43.3	29	0	0	29	29.0	5
2	154	157.3	193	1	0	194	195.3	7
0	47	47.0	38	0	0	38	38.0	1
0	28	28.0	35	0	0	35	35.0	0
0	44	44.0	49	0	0	49	49.0	0
1	47	48.0	31	0	0	31	31.0	0
1	166	167.0	153	0	0	153	153.0	1
0	35	35.0	19	0	0	19	19.0	2
1	31	32.0	18	0	0	18	18.0	0
0	29	29.0	15	1	0	16	17.3	1
0	19	19.0	8	0	0	8	8.0	0
1	114	115.0	60	1	0	61	62.3	3

4	434	439.3	406	2	0	408	410.6	11
---	-----	-------	-----	---	---	-----	-------	----



Queues M

U-Turn			
HEAVY	BUS	TOTAL	PCUs
0	0	0	0.0
0	0	0	0.0
0	0	0	0.0
0	0	0	0.0
0	0	0	0.0
0	0	1	1.0
0	0	0	0.0
0	0	0	0.0
0	0	0	0.0
0	0	0	0.0
0	0	1	1.0
0	0	1	1.0
0	0	0	0.0
0	0	0	0.0
0	0	2	2.0

0	0	3	3.0
---	---	---	-----

0	0	0	0.0
0	0	0	0.0
0	0	2	2.0
0	0	5	5.0
0	0	7	7.0
0	0	1	1.0
0	0	0	0.0
0	0	0	0.0
0	0	0	0.0
0	0	0	0.0
0	0	1	1.0
0	0	2	2.0
0	0	0	0.0
0	0	1	1.0
0	0	0	0.0
0	0	3	3.0

0	0	11	11.0
---	---	----	------

PCU Factors:	
LIGHT	1.0
HEAVY	2.3
BUS	2.0

TIME
700
705
710
715
720
725
730
735
740
745
750
755
800
805
810
815
820
825
830
835
840
845
850
855
900
905
910
915
920
925
930
935
940
945
950
955

Measured as Stationary Vehicles (Maximum Queue every 5 Minutes)

Queue Lengths (Vehicles)
0
2
0
4
0
2
2
3
0
4
3
3
4
2
3
3
4
4
4
2
0
2
2
3
4
2
0
2
3
3
4
2
3
3
3
3

TIME	Queue Lengths (Vehicles)
1600	4
1605	3
1610	3
1615	4
1620	3
1625	5
1630	4
1635	2
1640	4
1645	4
1650	3
1655	4
1700	5
1705	2
1710	3
1715	3
1720	4
1725	4
1730	4
1735	5
1740	2
1745	3
1750	3
1755	4
1800	3
1805	3
1810	4
1815	0
1820	3
1825	3
1830	4
1835	3
1840	3
1845	4
1850	3
1855	3

Colney Heath, Tuesday 29th March 2022

Junction: 3
Approach: Fellowes Lane



Queues Measured as Stationary Vehicles (Maximum Queue every 5 Minutes)

TIME	Left to Tollgate Road (East)					Right to Tollgate Road (West)				
	LIGHT	HEAVY	BUS	TOTAL	PCUs	LIGHT	HEAVY	BUS	TOTAL	PCUs
07:00 - 07:15	0	0	0	0	0.0	7	0	0	7	7.0
07:15 - 07:30	0	0	0	0	0.0	2	0	0	2	2.0
07:30 - 07:45	2	0	0	2	2.0	3	0	0	3	3.0
07:45 - 08:00	0	0	0	0	0.0	2	0	0	2	2.0
Hourly Total	2	0	0	2	2.0	14	0	0	14	14.0
08:00 - 08:15	0	0	0	0	0.0	5	0	0	5	5.0
08:15 - 08:30	0	0	0	0	0.0	3	0	0	3	3.0
08:30 - 08:45	0	0	0	0	0.0	2	1	0	3	4.3
08:45 - 09:00	0	0	0	0	0.0	7	0	0	7	7.0
Hourly Total	0	0	0	0	0.0	17	1	0	18	19.3
09:00 - 09:15	0	0	0	0	0.0	5	1	0	6	7.3
09:15 - 09:30	1	0	0	1	1.0	3	0	0	3	3.0
09:30 - 09:45	1	0	0	1	1.0	1	0	0	1	1.0
09:45 - 10:00	0	0	0	0	0.0	3	0	0	3	3.0
Hourly Total	2	0	0	2	2.0	12	1	0	13	14.3

TOTAL	4	0	0	4	4.0	43	2	0	45	47.6
--------------	----------	----------	----------	----------	------------	-----------	----------	----------	-----------	-------------

16:00 - 16:15	1	0	0	1	1.0	8	0	0	8	8.0
16:15 - 16:30	1	0	0	1	1.0	5	0	0	5	5.0
16:30 - 16:45	1	0	0	1	1.0	3	0	0	3	3.0
16:45 - 17:00	0	0	0	0	0.0	2	0	0	2	2.0
Hourly Total	3	0	0	3	3.0	18	0	0	18	18.0
17:00 - 17:15	1	0	0	1	1.0	5	0	0	5	5.0
17:15 - 17:30	0	0	0	0	0.0	2	0	0	2	2.0
17:30 - 17:45	0	0	0	0	0.0	1	0	0	1	1.0
17:45 - 18:00	1	0	0	1	1.0	2	0	0	2	2.0
Hourly Total	2	0	0	2	2.0	10	0	0	10	10.0
18:00 - 18:15	2	0	0	2	2.0	0	0	0	0	0.0
18:15 - 18:30	3	0	0	3	3.0	0	0	0	0	0.0
18:30 - 18:45	0	0	0	0	0.0	6	0	0	6	6.0
18:45 - 19:00	0	0	0	0	0.0	2	0	0	2	2.0
Hourly Total	5	0	0	5	5.0	8	0	0	8	8.0

TOTAL	10	0	0	10	10.0	36	0	0	36	36.0
--------------	-----------	----------	----------	-----------	-------------	-----------	----------	----------	-----------	-------------

PCU Factors:	
LIGHT	1.0
HEAVY	2.3
BUS	2.0

TIME	Queue Lengths (Vehicles)
700	0
705	2
710	0
715	0
720	0
725	0
730	0
735	0
740	0
745	0
750	0
755	0
800	0
805	0
810	2
815	0
820	0
825	0
830	0
835	0
840	0
845	0
850	0
855	2
900	0
905	0
910	0
915	0
920	0
925	0
930	0
935	0
940	0
945	0
950	0
955	0

TIME	Queue Lengths (Vehicles)
1600	0
1605	0
1610	3
1615	0
1620	0
1625	0
1630	0
1635	0
1640	0
1645	0
1650	0
1655	0
1700	0
1705	0
1710	0
1715	0
1720	0
1725	0
1730	0
1735	0
1740	0
1745	0
1750	0
1755	0
1800	0
1805	2
1810	0
1815	0
1820	0
1825	0
1830	0
1835	0
1840	0
1845	0
1850	0
1855	0

Colney Heath, Tuesday 29th March 2022

Junction: 3

Approach: Tollgate Road East

TIME	Ahead to Tollgate Road (West)					Right	
	LIGHT	HEAVY	BUS	TOTAL	PCUs	LIGHT	HEAVY
07:00 - 07:15	61	1	0	62	63.3	0	0
07:15 - 07:30	80	1	0	81	82.3	0	0
07:30 - 07:45	99	1	0	100	101.3	0	0
07:45 - 08:00	110	1	0	111	112.3	0	0
Hourly Total	350	4	0	354	359.2	0	0
08:00 - 08:15	141	2	2	145	149.6	0	0
08:15 - 08:30	97	1	0	98	99.3	0	0
08:30 - 08:45	105	2	0	107	109.6	2	0
08:45 - 09:00	89	0	0	89	89.0	0	0
Hourly Total	432	5	2	439	447.5	2	0
09:00 - 09:15	57	3	0	60	63.9	0	0
09:15 - 09:30	68	4	1	73	79.2	1	0
09:30 - 09:45	45	1	0	46	47.3	0	0
09:45 - 10:00	51	0	0	51	51.0	0	0
Hourly Total	221	8	1	230	241.4	1	0

TOTAL	1003	17	3	1023	1048.1	3	0
--------------	-------------	-----------	----------	-------------	---------------	----------	----------

16:00 - 16:15	84	1	0	85	86.3	0	0
16:15 - 16:30	61	0	0	61	61.0	0	0
16:30 - 16:45	68	2	1	71	74.6	1	0
16:45 - 17:00	52	1	0	53	54.3	1	0
Hourly Total	265	4	1	270	276.2	2	0
17:00 - 17:15	99	1	0	100	101.3	0	0
17:15 - 17:30	74	1	1	76	78.3	0	0
17:30 - 17:45	68	0	0	68	68.0	0	0
17:45 - 18:00	52	0	0	52	52.0	1	0
Hourly Total	293	2	1	296	299.6	1	0
18:00 - 18:15	46	0	0	46	46.0	0	0
18:15 - 18:30	49	0	0	49	49.0	1	0
18:30 - 18:45	41	0	0	41	41.0	0	0
18:45 - 19:00	41	0	0	41	41.0	0	0
Hourly Total	177	0	0	177	177.0	1	0

TOTAL	735	6	2	743	752.8	4	0
--------------	------------	----------	----------	------------	--------------	----------	----------



to Fellowes Lane			U-Turn				
BUS	TOTAL	PCUs	LIGHT	HEAVY	BUS	TOTAL	PCUs
0	0	0.0	0	0	0	0	0.0
0	0	0.0	0	0	0	0	0.0
0	0	0.0	0	0	0	0	0.0
0	0	0.0	0	0	0	0	0.0
0	0	0.0	0	0	0	0	0.0
0	0	0.0	0	0	0	0	0.0
0	0	0.0	0	0	0	0	0.0
0	0	0.0	0	0	0	0	0.0
0	2	2.0	0	0	0	0	0.0
0	0	0.0	0	0	0	0	0.0
0	2	2.0	0	0	0	0	0.0
0	0	0.0	1	0	0	1	1.0
0	1	1.0	0	0	0	0	0.0
0	0	0.0	0	0	0	0	0.0
0	0	0.0	0	0	0	0	0.0
0	1	1.0	1	0	0	1	1.0

0	3	3.0	1	0	0	1	1.0
---	---	-----	---	---	---	---	-----

0	0	0.0	0	0	0	0	0.0
0	0	0.0	0	0	0	0	0.0
0	1	1.0	0	0	0	0	0.0
0	1	1.0	0	0	0	0	0.0
0	2	2.0	0	0	0	0	0.0
0	0	0.0	0	0	0	0	0.0
0	0	0.0	0	0	0	0	0.0
0	0	0.0	0	0	0	0	0.0
0	0	0.0	0	0	0	0	0.0
0	1	1.0	0	0	0	0	0.0
0	1	1.0	0	0	0	0	0.0
0	0	0.0	0	0	0	0	0.0
0	1	1.0	0	0	0	0	0.0
0	0	0.0	0	0	0	0	0.0
0	0	0.0	0	0	0	0	0.0
0	0	0.0	0	0	0	0	0.0
0	1	1.0	0	0	0	0	0.0

0	4	4.0	0	0	0	0	0.0
---	---	-----	---	---	---	---	-----



Queues Measured as Stationary Vehicles (Maximum Queue every 5

PCU Factors:	
LIGHT	1.0
HEAVY	2.3
BUS	2.0

TIME	Queue Lengths (Vehicles)
700	0
705	0
710	0
715	0
720	0
725	0
730	0
735	0
740	0
745	0
750	0
755	0
800	0
805	0
810	0
815	0
820	0
825	0
830	0
835	0
840	0
845	0
850	0
855	0
900	0
905	0
910	0
915	0
920	0
925	0
930	0
935	0
940	0
945	0
950	0
955	0

TIME
1600
1605
1610
1615
1620
1625
1630
1635
1640
1645
1650
1655
1700
1705
1710
1715
1720
1725
1730
1735
1740
1745
1750
1755
1800
1805
1810
1815
1820
1825
1830
1835
1840
1845
1850
1855

Colney Heath, Tuesday 29th March 2022

Junction: 3

Approach: Tollgate Road West

TIME	Left to Fellowes Lane					Ahead to	
	LIGHT	HEAVY	BUS	TOTAL	PCUs	LIGHT	HEAVY
07:00 - 07:15	4	0	0	4	4.0	39	0
07:15 - 07:30	5	0	0	5	5.0	46	0
07:30 - 07:45	4	0	0	4	4.0	47	2
07:45 - 08:00	6	0	0	6	6.0	69	0
Hourly Total	19	0	0	19	19.0	201	2
08:00 - 08:15	1	1	0	2	3.3	62	0
08:15 - 08:30	7	0	0	7	7.0	68	2
08:30 - 08:45	1	0	0	1	1.0	67	0
08:45 - 09:00	3	0	0	3	3.0	77	1
Hourly Total	12	1	0	13	14.3	274	3
09:00 - 09:15	2	0	0	2	2.0	86	0
09:15 - 09:30	3	2	0	5	7.6	63	1
09:30 - 09:45	0	0	0	0	0.0	56	1
09:45 - 10:00	3	0	0	3	3.0	41	2
Hourly Total	8	2	0	10	12.6	246	4

TOTAL	39	3	0	42	45.9	721	9
--------------	-----------	----------	----------	-----------	-------------	------------	----------

16:00 - 16:15	6	0	0	6	6.0	86	0
16:15 - 16:30	4	0	0	4	4.0	79	2
16:30 - 16:45	4	0	0	4	4.0	68	0
16:45 - 17:00	5	1	0	6	7.3	85	0
Hourly Total	19	1	0	20	21.3	318	2
17:00 - 17:15	6	0	0	6	6.0	85	0
17:15 - 17:30	2	0	0	2	2.0	75	1
17:30 - 17:45	5	0	0	5	5.0	81	0
17:45 - 18:00	7	0	0	7	7.0	88	0
Hourly Total	20	0	0	20	20.0	329	1
18:00 - 18:15	5	0	0	5	5.0	75	1
18:15 - 18:30	3	0	0	3	3.0	57	0
18:30 - 18:45	2	0	0	2	2.0	60	0
18:45 - 19:00	2	0	0	2	2.0	39	1
Hourly Total	12	0	0	12	12.0	231	2

TOTAL	51	1	0	52	53.3	878	5
--------------	-----------	----------	----------	-----------	-------------	------------	----------



Queues M

Tollgate Road (East)

BUS	TOTAL	PCUs
0	39	39.0
0	46	46.0
0	49	51.6
2	71	73.0
2	205	209.6
0	62	62.0
5	75	82.6
1	68	69.0
0	78	79.3
6	283	292.9
0	86	86.0
0	64	65.3
0	57	58.3
0	43	45.6
0	250	255.2

8	738	757.7
---	-----	-------

0	86	86.0
1	82	85.6
1	69	70.0
0	85	85.0
2	322	326.6
0	85	85.0
0	76	77.3
0	81	81.0
1	89	90.0
1	331	333.3
0	76	77.3
1	58	59.0
0	60	60.0
0	40	41.3
1	234	237.6

4	887	897.5
---	-----	-------

PCU Factors:	
LIGHT	1.0
HEAVY	2.3
BUS	2.0

TIME
700
705
710
715
720
725
730
735
740
745
750
755
800
805
810
815
820
825
830
835
840
845
850
855
900
905
910
915
920
925
930
935
940
945
950
955

Colney Heath, Tuesday 29th March 2022

Junction: 4
 Approach: Dixons Hill Road East



Queues Measured as Stationary Vehicles (Maximum Queue every 5 Minutes)

TIME	Left to Swanland Road					Ahead to Dixons Hill Road (West)				
	LIGHT	HEAVY	BUS	TOTAL	PCUs	LIGHT	HEAVY	BUS	TOTAL	PCUs
07:00 - 07:15	39	1	1	41	43.3	47	0	0	47	47.0
07:15 - 07:30	60	0	1	61	62.0	70	1	1	72	74.3
07:30 - 07:45	56	1	0	57	58.3	84	0	1	85	86.0
07:45 - 08:00	64	2	0	66	68.6	94	3	1	98	102.9
Hourly Total	219	4	2	225	232.2	295	4	3	302	310.2
08:00 - 08:15	54	0	1	55	56.0	121	1	1	123	125.3
08:15 - 08:30	67	3	0	70	73.9	82	1	0	83	84.3
08:30 - 08:45	51	1	0	52	53.3	91	1	0	92	93.3
08:45 - 09:00	42	1	0	43	44.3	73	1	0	74	75.3
Hourly Total	234	5	1	220	227.5	367	4	1	372	378.2
09:00 - 09:15	38	1	0	39	40.3	47	3	0	50	53.9
09:15 - 09:30	35	2	0	37	39.6	55	3	1	59	63.9
09:30 - 09:45	23	3	0	26	29.9	42	0	0	42	42.0
09:45 - 10:00	35	1	0	36	37.3	38	1	0	39	40.3
Hourly Total	131	7	0	138	147.1	182	7	1	190	200.1
TOTAL	564	16	3	583	606.8	844	15	5	864	888.5

16:00 - 16:15	39	2	0	41	43.6	56	0	0	56	56.0
16:15 - 16:30	29	0	1	30	31.0	44	0	0	44	44.0
16:30 - 16:45	28	1	0	29	30.3	61	2	1	64	67.6
16:45 - 17:00	36	1	0	37	38.3	49	1	0	50	51.3
Hourly Total	132	4	1	137	143.2	210	3	1	214	218.9
17:00 - 17:15	32	0	0	32	32.0	77	1	0	78	79.3
17:15 - 17:30	44	2	0	46	48.6	64	1	1	66	68.3
17:30 - 17:45	33	0	0	33	33.0	53	0	0	53	53.0
17:45 - 18:00	47	0	0	47	47.0	40	0	0	40	40.0
Hourly Total	156	2	0	158	160.6	234	2	1	237	240.6
18:00 - 18:15	30	0	0	30	30.0	32	0	0	32	32.0
18:15 - 18:30	25	2	1	28	31.6	32	0	0	32	32.0
18:30 - 18:45	24	0	0	24	24.0	35	0	0	35	35.0
18:45 - 19:00	21	0	0	21	21.0	28	0	0	28	28.0
Hourly Total	100	2	1	103	106.6	127	0	0	127	127.0
TOTAL	388	8	2	398	410.4	571	5	2	578	586.5

PCU Factors:	
LIGHT	1.0
HEAVY	2.3
BUS	2.0

TIME	Queue Lengths (Vehicles)
700	0
705	0
710	0
715	0
720	0
725	0
730	0
735	0
740	0
745	0
750	0
755	0
800	0
805	0
810	0
815	0
820	0
825	0
830	0
835	0
840	0
845	0
850	0
855	0
900	0
905	0
910	0
915	0
920	0
925	0
930	0
935	0
940	0
945	0
950	0
955	0

TIME	Queue Lengths (Vehicles)
1600	0
1605	0
1610	0
1615	0
1620	0
1625	0
1630	0
1635	0
1640	0
1645	0
1650	0
1655	0
1700	0
1705	0
1710	0
1715	0
1720	0
1725	0
1730	0
1735	0
1740	0
1745	0
1750	0
1755	0
1800	0
1805	0
1810	0
1815	0
1820	0
1825	0
1830	0
1835	0
1840	0
1845	0
1850	0
1855	0

Colney Heath, Tuesday 29th March 2022

Junction: 4
 Approach: Swanland Road



Queues Measured as Stationary Vehicles (Maximum Queue every 5 Minutes)

TIME	Left to Dixons Hill Road (West)				Right to Dixons Hill Road (East)					
	LIGHT	HEAVY	BUS	TOTAL	PCUs	LIGHT	HEAVY	BUS	TOTAL	PCUs
07:00 - 07:15	9	0	0	9	9.0	18	0	2	20	22.0
07:15 - 07:30	12	0	0	12	12.0	10	2	0	12	14.6
07:30 - 07:45	12	0	0	12	12.0	32	0	1	33	34.0
07:45 - 08:00	14	0	0	14	14.0	27	1	0	28	29.3
Hourly Total	47	0	0	47	47.0	87	3	3	93	99.9
08:00 - 08:15	18	0	0	18	18.0	43	1	0	44	45.3
08:15 - 08:30	15	0	0	15	15.0	35	1	0	36	37.3
08:30 - 08:45	15	0	0	15	15.0	42	0	1	43	44.0
08:45 - 09:00	14	0	0	14	14.0	27	1	0	28	29.3
Hourly Total	62	0	0	62	62.0	147	3	1	151	155.9
09:00 - 09:15	11	0	0	11	11.0	23	2	0	25	27.6
09:15 - 09:30	9	0	0	9	9.0	34	0	0	34	34.0
09:30 - 09:45	7	0	0	7	7.0	29	1	1	31	33.3
09:45 - 10:00	11	0	0	11	11.0	19	1	0	20	21.3
Hourly Total	38	0	0	38	38.0	105	4	1	110	116.2
TOTAL	147	0	0	147	147.0	339	10	5	354	372.0

16:00 - 16:15	19	1	0	20	21.3	56	0	0	56	56.0
16:15 - 16:30	14	0	0	14	14.0	48	1	0	49	50.3
16:30 - 16:45	13	0	0	13	13.0	41	1	0	42	43.3
16:45 - 17:00	17	0	0	17	17.0	38	0	0	38	38.0
Hourly Total	63	1	0	64	65.3	183	2	0	185	187.6
17:00 - 17:15	19	0	0	19	19.0	44	0	0	44	44.0
17:15 - 17:30	16	1	0	17	18.3	48	1	0	49	50.3
17:30 - 17:45	19	0	0	19	19.0	27	1	0	28	29.3
17:45 - 18:00	14	0	0	14	14.0	45	4	0	49	54.2
Hourly Total	68	1	0	69	70.3	164	6	0	170	177.8
18:00 - 18:15	15	0	0	15	15.0	48	0	0	48	48.0
18:15 - 18:30	12	0	0	12	12.0	37	1	0	38	39.3
18:30 - 18:45	8	0	0	8	8.0	23	0	0	23	23.0
18:45 - 19:00	8	0	0	8	8.0	17	0	0	17	17.0
Hourly Total	43	0	0	43	43.0	125	1	0	126	127.3
TOTAL	174	2	0	176	178.6	472	9	0	481	492.7

PCU Factors:	
LIGHT	1.0
HEAVY	2.3
BUS	2.0

TIME	Queue Lengths (Vehicles)
700	5
705	7
710	4
715	4
720	5
725	6
730	4
735	5
740	3
745	3
750	5
755	6
800	3
805	3
810	3
815	4
820	5
825	4
830	4
835	5
840	6
845	3
850	3
855	3
900	4
905	4
910	8
915	3
920	3
925	4
930	3
935	4
940	3
945	3
950	3
955	3

TIME	Queue Lengths (Vehicles)
1600	2
1605	6
1610	4
1615	7
1620	4
1625	4
1630	5
1635	3
1640	6
1645	5
1650	4
1655	7
1700	4
1705	6
1710	6
1715	5
1720	6
1725	4
1730	5
1735	5
1740	5
1745	4
1750	4
1755	6
1800	3
1805	3
1810	5
1815	4
1820	4
1825	3
1830	5
1835	4
1840	3
1845	3
1850	3
1855	4

Colney Heath, Tuesday 29th March 2022

Junction: 4
 Approach: Dixons Hill Road West



Queues Measured as Stationary Vehicles (Maximum Queue every 5 Minutes)

TIME	Ahead to Dixons Hill Road (East)				Right to Swanland Road					
	LIGHT	HEAVY	BUS	TOTAL	PCUs	LIGHT	HEAVY	BUS	TOTAL	PCUs
07:00 - 07:15	32	0	0	32	32.0	3	0	0	3	3.0
07:15 - 07:30	35	0	0	35	35.0	16	0	0	16	16.0
07:30 - 07:45	31	2	0	33	35.6	19	0	0	19	19.0
07:45 - 08:00	62	0	2	64	66.0	22	0	0	22	22.0
Hourly Total	160	2	2	164	168.6	60	0	0	60	60.0
08:00 - 08:15	44	0	0	44	44.0	18	1	0	19	20.3
08:15 - 08:30	52	1	0	53	54.3	10	0	1	11	12.0
08:30 - 08:45	57	1	0	58	59.3	13	0	5	18	23.0
08:45 - 09:00	50	1	0	51	52.3	17	0	0	17	17.0
Hourly Total	203	3	0	206	209.9	58	1	6	65	72.3
09:00 - 09:15	60	0	0	60	60.0	22	0	0	22	22.0
09:15 - 09:30	46	1	0	47	48.3	9	0	0	9	9.0
09:30 - 09:45	38	0	0	38	38.0	8	1	0	9	10.3
09:45 - 10:00	43	1	0	44	45.3	13	1	0	14	15.3
Hourly Total	187	2	0	189	191.6	52	2	0	54	56.6
TOTAL	550	7	2	559	570.1	170	3	6	179	188.9

16:00 - 16:15	59	0	0	59	59.0	15	0	0	15	15.0
16:15 - 16:30	68	2	1	71	74.6	10	0	0	10	10.0
16:30 - 16:45	61	0	1	62	63.0	8	0	0	8	8.0
16:45 - 17:00	74	0	0	74	74.0	10	0	0	10	10.0
Hourly Total	262	2	2	266	270.6	43	0	0	43	43.0
17:00 - 17:15	74	0	1	75	76.0	18	0	0	18	18.0
17:15 - 17:30	60	1	0	61	62.3	13	0	0	13	13.0
17:30 - 17:45	72	0	0	72	72.0	12	0	0	12	12.0
17:45 - 18:00	62	0	1	63	64.0	21	0	0	21	21.0
Hourly Total	268	1	2	271	274.3	64	0	0	64	64.0
18:00 - 18:15	64	1	0	65	66.3	9	0	0	9	9.0
18:15 - 18:30	69	0	1	70	71.0	3	0	0	3	3.0
18:30 - 18:45	49	0	0	49	49.0	16	0	0	16	16.0
18:45 - 19:00	40	0	0	40	40.0	3	0	0	3	3.0
Hourly Total	222	1	1	224	226.3	31	0	0	31	31.0
TOTAL	752	4	5	761	771.2	138	0	0	138	138.0

PCU Factors:	
LIGHT	1.0
HEAVY	2.3
BUS	2.0

TIME	Queue Lengths (Vehicles)	
	Right Turn	
700	0	
705	0	
710	2	
715	0	
720	3	
725	2	
730	4	
735	0	
740	2	
745	2	
750	0	
755	2	
800	2	
805	3	
810	0	
815	2	
820	2	
825	0	
830	2	
835	2	
840	0	
845	3	
850	0	
855	2	
855	2	
900	2	
905	2	
910	3	
915	0	
920	0	
925	0	
930	0	
935	0	
940	0	
945	0	
950	0	
955	0	

TIME	Queue Lengths (Vehicles)	
	Right Turn	
1600	0	
1605	0	
1610	2	
1615	0	
1620	0	
1625	2	
1630	0	
1635	0	
1640	0	
1645	0	
1650	0	
1655	0	
1700	2	
1705	0	
1710	2	
1715	3	
1720	0	
1725	2	
1730	0	
1735	2	
1740	2	
1745	3	
1750	0	
1755	2	
1800	0	
1805	0	
1810	0	
1815	0	
1820	2	
1825	0	
1830	0	
1835	0	
1840	0	
1845	0	
1850	0	
1855	0	

Colney Heath, Tuesday 29th March 2022

Junction: 5
 Approach: A1000 Great North Road North



Queues Measured as Stationary Vehicles (Maximum Queue every 5 Minutes)

TIME	Ahead to A1000 Great North Road (South)				Right to Dixons Hill Road				U-Turn						
	LIGHT	HEAVY	BUS	TOTAL PCUs	LIGHT	HEAVY	BUS	TOTAL PCUs	LIGHT	HEAVY	BUS	TOTAL PCUs			
07:00-07:15	86	2	2	90	94.6	69	3	1	73	77.9	0	1	0	1	2.3
07:15-07:30	117	2	1	120	123.6	115	0	2	117	119.0	0	0	0	0	0.0
07:30-07:45	126	3	0	129	132.6	110	2	0	112	114.6	0	0	0	0	0.0
07:45-08:00	127	5	0	132	138.5	143	5	1	149	155.5	0	1	0	1	2.3
Hourly Total	456	12	3	471	489.6	437	10	4	451	468.0	0	2	0	2	4.6
08:00-08:15	140	4	0	144	148.2	140	4	0	144	148.2	0	0	0	0	0.0
08:15-08:30	95	6	0	102	106.8	149	5	0	154	159.5	0	0	0	0	0.0
08:30-08:45	102	4	0	106	111.2	119	6	0	125	132.8	2	0	0	2	2.0
08:45-09:00	101	2	0	103	105.6	98	6	1	105	113.8	1	0	0	1	1.0
Hourly Total	489	16	0	495	507.8	506	21	1	528	556.3	3	0	0	3	3.0
09:00-09:15	93	2	0	95	97.6	68	5	3	76	85.5	1	0	0	1	1.0
09:15-09:30	84	4	0	88	93.2	58	4	1	63	69.2	0	0	0	0	0.0
09:30-09:45	76	3	0	79	82.9	51	3	0	54	57.9	1	0	0	1	1.0
09:45-10:00	88	7	0	95	104.3	66	6	2	74	83.8	1	0	0	1	1.0
Hourly Total	341	16	0	357	377.8	243	18	6	267	295.4	3	0	0	3	3.0
TOTAL	1236	44	3	1283	1343.2	1186	49	11	1246	1320.7	6	2	0	8	10.6
16:00-16:15	122	6	0	128	135.8	79	3	1	83	87.9	1	0	0	1	1.0
16:15-16:30	141	3	0	144	147.9	70	1	1	72	74.3	0	0	0	0	0.0
16:30-16:45	130	4	0	134	139.2	82	2	0	84	86.6	0	0	0	0	0.0
16:45-17:00	113	1	0	114	115.3	81	2	1	84	87.6	0	0	0	0	0.0
Hourly Total	506	14	0	520	538.2	312	6	3	323	336.4	1	0	0	1	1.0
17:00-17:15	135	1	0	136	137.3	76	4	0	80	85.2	0	0	0	0	0.0
17:15-17:30	139	3	0	142	145.0	79	3	1	83	87.9	0	0	0	0	0.0
17:30-17:45	126	0	1	127	128.0	80	1	0	81	82.3	0	0	0	0	0.0
17:45-18:00	156	0	0	156	156.0	68	1	0	69	70.3	0	0	0	0	0.0
Hourly Total	556	4	1	561	567.2	303	9	1	313	325.7	0	0	0	0	0.0
18:00-18:15	131	0	0	131	131.0	66	1	0	67	68.3	0	0	0	0	0.0
18:15-18:30	72	0	0	72	72.0	51	2	0	53	55.6	0	0	0	0	0.0
18:30-18:45	82	0	0	82	82.0	61	0	1	62	63.0	1	0	0	1	1.0
18:45-19:00	67	0	0	67	67.0	33	3	0	36	39.9	0	0	0	0	0.0
Hourly Total	352	0	0	352	352.0	211	6	1	218	226.8	1	0	0	1	1.0
TOTAL	1414	18	1	1433	1457.4	826	23	5	854	888.9	2	0	0	2	2.0

PCU Factors:	
LIGHT	1.0
HEAVY	2.3
BUS	2.0

TIME	Queue Lengths (Vehicles)
700	0
705	0
710	0
715	0
720	0
725	0
730	0
735	0
740	0
745	0
750	0
755	0
800	0
805	3
810	2
815	0
820	2
825	2
830	2
835	5
840	2
845	0
850	0
855	0
900	0
905	3
910	0
915	0
920	0
925	0
930	0
935	2
940	2
945	0
950	0
955	0

TIME	Queue Lengths (Vehicles)
1600	0
1605	0
1610	0
1615	0
1620	0
1625	2
1630	0
1635	0
1640	0
1645	0
1650	0
1655	0
1700	0
1705	0
1710	0
1715	0
1720	2
1725	3
1730	0
1735	2
1740	2
1745	0
1750	0
1755	4
1800	2
1805	2
1810	4
1815	0
1820	2
1825	0
1830	0
1835	0
1840	0
1845	0
1850	0
1855	0

Colney Heath, Tuesday 29th March 2022

Junction: 5
 Approach: A1000 Great North Road South



Queues Measured as Stationary Vehicles (Maximum Queue every 5 Minutes)

TIME	Left to Dixons Hill Road				Ahead to A1000 Great North Road (North)				U-Turn						
	LIGHT	HEAVY	BUS	TOTAL	PCUs	LIGHT	HEAVY	BUS	TOTAL	PCUs	LIGHT	HEAVY	BUS	TOTAL	PCUs
07:00-07:15	58	1	0	59	60.3	54	7	0	61	70.1	0	0	0	0	0.0
07:15-07:30	46	1	1	48	50.3	73	4	0	77	82.2	0	0	0	0	0.0
07:30-07:45	56	1	0	57	58.3	108	2	0	110	112.6	0	0	0	0	0.0
07:45-08:00	72	2	0	74	76.6	137	1	1	139	141.3	0	0	0	0	0.0
Hourly Total	232	5	1	238	245.5	372	14	1	387	406.2	0	0	0	0	0.0
08:00-08:15	86	0	1	87	88.0	153	1	2	156	159.3	0	0	0	0	0.0
08:15-08:30	78	2	0	80	81.6	141	5	0	146	152.5	0	0	1	1	2.0
08:30-08:45	51	3	0	54	57.9	100	3	1	104	108.9	0	0	0	0	0.0
08:45-09:00	56	2	0	58	60.6	84	7	0	91	100.1	0	0	0	0	0.0
Hourly Total	272	7	1	280	290.1	478	16	3	497	520.8	0	0	1	1	2.0
09:00-09:15	42	7	0	49	51.1	75	3	0	78	81.9	0	0	0	0	0.0
09:15-09:30	33	2	1	36	39.6	95	2	0	97	99.6	0	0	0	0	0.0
09:30-09:45	27	1	0	28	29.3	75	3	0	78	81.9	0	0	1	1	2.0
09:45-10:00	26	1	0	27	28.3	61	7	0	68	97.1	0	0	0	0	0.0
Hourly Total	128	11	1	140	155.3	326	15	0	341	365.5	0	0	1	1	2.0
TOTAL	632	23	3	658	690.9	1176	45	4	1225	1287.5	0	0	2	2	4.0
16:00-16:15	40	1	0	41	42.3	103	2	0	105	107.6	0	0	0	0	0.0
16:15-16:30	38	2	0	40	42.6	108	3	0	111	114.9	0	0	0	0	0.0
16:30-16:45	36	0	0	36	36.0	110	1	0	111	112.3	0	0	0	0	0.0
16:45-17:00	31	0	0	31	31.0	107	0	0	107	107.0	0	0	0	0	0.0
Hourly Total	145	3	0	148	151.9	429	6	0	434	441.8	0	0	0	0	0.0
17:00-17:15	38	0	0	38	38.0	125	3	2	130	135.9	0	0	0	0	0.0
17:15-17:30	32	1	0	33	34.3	114	0	0	114	114.0	0	0	0	0	0.0
17:30-17:45	30	0	0	30	30.0	119	0	0	119	119.0	0	0	0	0	0.0
17:45-18:00	24	0	0	24	24.0	92	1	0	93	94.3	0	0	0	0	0.0
Hourly Total	124	1	0	125	126.3	450	4	2	456	463.2	0	0	0	0	0.0
18:00-18:15	21	0	0	21	21.0	82	2	0	84	86.6	0	0	0	0	0.0
18:15-18:30	15	1	0	16	17.3	83	0	1	84	85.0	0	0	0	0	0.0
18:30-18:45	15	0	0	15	15.0	74	1	0	75	76.3	0	0	0	0	0.0
18:45-19:00	16	0	0	16	16.0	67	0	0	67	67.0	0	0	0	0	0.0
Hourly Total	67	1	0	68	69.3	306	3	1	310	314.9	0	0	0	0	0.0
TOTAL	336	5	0	341	347.5	1184	13	3	1200	1219.9	0	0	0	0	0.0

PCU Factors:	
LIGHT	1.0
HEAVY	2.3
BUS	2.0

TIME	Queue Lengths (Vehicles)
700	0
705	0
710	0
715	0
720	0
725	0
730	0
735	0
740	0
745	0
750	2
755	0
800	0
805	2
810	5
815	2
820	2
825	4
830	3
835	2
840	2
845	0
850	2
855	2
900	0
905	2
910	0
915	2
920	0
925	0
930	3
935	2
940	0
945	2
950	4
955	0

TIME	Queue Lengths (Vehicles)
1600	0
1605	0
1610	0
1615	0
1620	2
1625	3
1630	0
1635	0
1640	0
1645	0
1650	3
1655	0
1700	0
1705	0
1710	0
1715	0
1720	0
1725	0
1730	2
1735	2
1740	0
1745	2
1750	4
1755	2
1800	0
1805	2
1810	0
1815	0
1820	0
1825	0
1830	0
1835	0
1840	0
1845	0
1850	0
1855	0

Colney Heath, Tuesday 29th March 2022

Junction: 5
 Approach: Dixons Hill Road



Queues Measured as Stationary Vehicles (Maximum Queue every 5 Minutes)

TIME	Left to A1000 Great North Road (North)					Right to A1000 Great North Road (South)				
	LIGHT	HEAVY	BUS	TOTAL	PCUs	LIGHT	HEAVY	BUS	TOTAL	PCUs
07:00 - 07:15	32	2	2	36	40.6	27	1	0	28	29.3
07:15 - 07:30	48	5	0	53	59.5	20	1	0	21	22.3
07:30 - 07:45	50	5	1	56	63.5	22	1	0	23	24.3
07:45 - 08:00	75	1	2	78	81.3	37	2	1	40	43.6
Hourly Total	205	13	5	223	244.9	106	5	1	112	119.5
08:00 - 08:15	83	4	1	88	94.2	43	0	0	43	43.0
08:15 - 08:30	93	6	0	99	106.8	32	0	0	32	32.0
08:30 - 08:45	78	1	0	79	80.3	18	1	0	19	20.3
08:45 - 09:00	95	2	1	98	101.6	26	0	0	26	26.0
Hourly Total	349	13	2	364	382.9	119	1	0	120	121.3
09:00 - 09:15	58	5	0	63	69.5	23	4	0	27	32.2
09:15 - 09:30	66	5	1	72	79.5	33	1	0	34	35.3
09:30 - 09:45	64	6	3	73	83.8	32	0	1	33	34.0
09:45 - 10:00	56	5	1	62	69.5	27	1	0	28	29.3
Hourly Total	244	21	5	270	302.3	115	6	1	122	130.8
TOTAL	798	47	12	857	930.1	340	12	2	354	371.6

PCU Factors:	
LIGHT	1.0
HEAVY	2.3
BUS	2.0

TIME	Queue Lengths (Vehicles)
700	0
705	0
710	0
715	0
720	0
725	0
730	0
735	3
740	0
745	2
750	2
755	0
800	2
805	5
810	2
815	3
820	3
825	0
830	3
835	5
840	2
845	2
850	0
855	3
900	0
905	4
910	2
915	2
920	0
925	2
930	2
935	0
940	0
945	0
950	0
955	0

TIME	Queue Lengths (Vehicles)
1600	0
1605	0
1610	2
1615	0
1620	0
1625	0
1630	2
1635	3
1640	0
1645	2
1650	5
1655	2
1700	2
1705	2
1710	7
1715	3
1720	3
1725	3
1730	2
1735	3
1740	2
1745	2
1750	0
1755	2
1800	2
1805	0
1810	4
1815	3
1820	3
1825	2
1830	2
1835	5
1840	2
1845	0
1850	0
1855	0

16:00 - 16:15	115	4	1	120	126.2	56	0	0	56	56.0
16:15 - 16:30	105	1	1	107	109.3	34	1	0	35	36.3
16:30 - 16:45	125	1	0	126	127.3	51	0	0	51	51.0
16:45 - 17:00	96	3	1	100	104.9	57	0	0	57	57.0
Hourly Total	441	9	3	453	467.7	198	1	0	199	200.3
17:00 - 17:15	169	0	2	171	173.0	63	0	0	63	63.0
17:15 - 17:30	100	1	0	101	102.3	46	2	0	48	50.6
17:30 - 17:45	104	2	0	106	108.6	55	1	0	56	57.3
17:45 - 18:00	87	5	1	93	100.5	55	0	0	55	55.0
Hourly Total	460	8	3	471	484.4	219	3	0	222	225.9
18:00 - 18:15	72	0	2	74	76.0	44	1	0	45	46.3
18:15 - 18:30	65	0	0	65	65.0	43	1	0	44	45.3
18:30 - 18:45	48	0	0	48	48.0	24	0	0	24	24.0
18:45 - 19:00	57	2	1	60	63.6	26	0	0	26	26.0
Hourly Total	242	2	3	247	252.6	137	2	0	139	141.6
TOTAL	1143	19	9	1171	1204.7	554	6	0	560	567.8

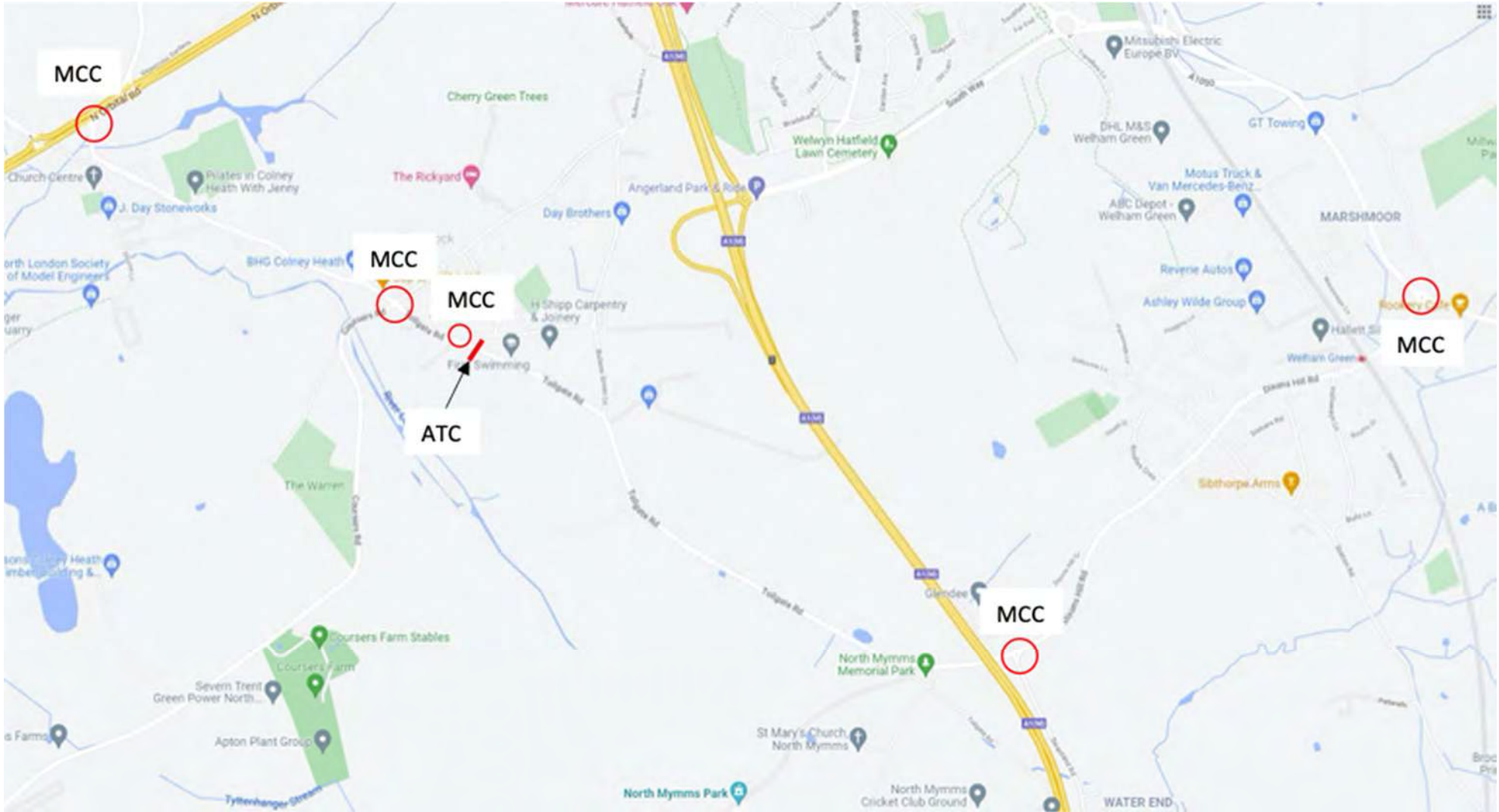

Appendix 4 – Parking Beat Survey

Parking Beat Survey

Tollgate Road, Colney Heath



Tuesday 29th March 2022



Created by Bert Ramos

SURVEY DETAILS

Survey Type	PARKING BEAT SURVEY
Methodology	
Guidance	London Borough of Lambeth
Site	Tollgate Road, Colney Heath
Survey Area	As advised by client
Date/s	Tuesday 29th March 2022
Time/s	12:00-13:00 & 20:00-21:00hrs
Beat Frequency	Snapshot
Unit for 1 Unmarked Lengthwise Space (m)	5
Unit for 1 Unmarked Crosswise Space (m)	2.5
Areas Excluded From Survey	Private parking spaces, private roads and off road parking (unless requested in survey specification).
Sections of road excluded from parking capacity calculation	<p>First 7.5m from junction mouth (for reasons of highway safety).</p> <p>Crossovers, dropped kerbs, build-outs, traffic islands, 24/7 illegal parking.</p> <p>Sections of legal lengthwise parking between illegal parking (crossover, dropped kerbs, double yellow etc) that measure less than the unit specified for 1 space.</p> <p>Where the width of the road is such that parking on both sides would cause an obstruction. In this instance one side of the road has been excluded from the capacity calculation.</p>
Parking excluded from stress calculation	<p>Skips or any other non-vehicle occupying a parking space (but noted separately if observed).</p> <p>Any illegal parking on double yellow lines, crossovers, keep clear lines etc (but noted separately if observed).</p>
Terminology	<p>"Parking Stress" - Calculation to express the number of parked vehicles as a percentage of available parking for each parking type. Stress can be over 100% if cars are small and/or parked very closely together.</p> <p>"Parking Capacity Calculation" - Measurement of each length of road between illegal parking (e.g. crossovers, traffic islands, double yellow etc) converted into parking spaces by rounding down to the nearest unit assigned to one parking space and dividing this figure by the unit.</p> <p>"Lengthwise Parking" - Vehicles parked in a lengthwise orientation with wheels parallel to the kerbside.</p> <p>"Crosswise Parking" - Vehicles parked in a crosswise orientation (as seen in car parks or wide sections of road)</p>

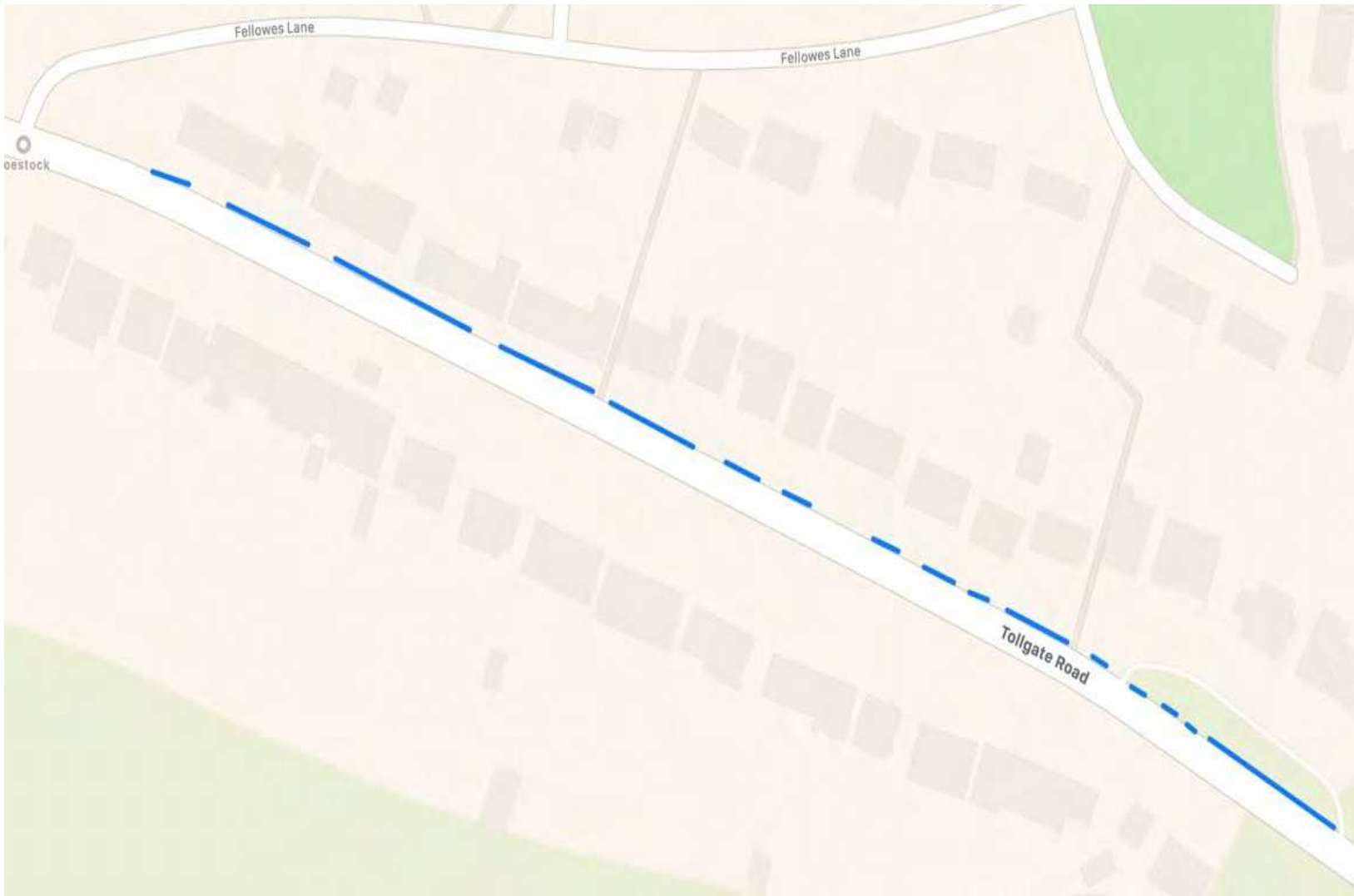

Key

**Unrestricted
Parking**

Unrestricted Kerb



North



PARKING STRESS TABLES

Restriction 1					Unrestricted Kerb					
					Tuesday 29th March 2022					
					12:15hrs			20:10hrs		
Location	Lengthwise Parking (m)	Lengthwise Spaces	Marked/Crosswise Bays	Total Spaces	Occupied	Spaces	Stress (%)	Occupied	Spaces	Stress (%)
Tollgate Road	170	34	0	34	8	26	24%	14	20	41%
Total	170	34	0	34	8	26	24%	14	20	41%

Illegal/Obstructive Parking

		Tuesday 29th March 2022			
		12:15hrs		20:10hrs	
		Occupied		Occupied	
		0		0	
Total		0		0	
Location	Description				

PARKING CAPACITY MEASUREMENTS

A working table showing kerbside measurements for each parking type.

Location	Side of Road & Measuring Orientation	Parking Type	Section Length (m)	Crosswise Spaces or Lengthwise Marked Bays	Number of Crosswise Spaces or Marked Bays	Unit Round Down (If Lengthwise & Unmarked)	Total Spaces
Tollgate Road	N W-E	Unrestricted Kerb	3.5			0	0
Tollgate Road	N W-E	Crossover	5.6			5	1
Tollgate Road	N W-E	Unrestricted Kerb	13.5			10	2
Tollgate Road	N W-E	Crossover	5			5	1
Tollgate Road	N W-E	Unrestricted Kerb	31.9			30	6
Tollgate Road	N W-E	Crossover	7.1			5	1
Tollgate Road	N W-E	Unrestricted Kerb	26.3			25	5
Tollgate Road	N W-E	Crossover	4.9			0	0
Tollgate Road	N W-E	Unrestricted Kerb	27.7			25	5
Tollgate Road	N W-E	Crossover	8.8			5	1
Tollgate Road	N W-E	Unrestricted Kerb	6.5			5	1
Tollgate Road	N W-E	Crossover	5.2			5	1
Tollgate Road	N W-E	Unrestricted Kerb	4.6			0	0
Tollgate Road	N W-E	Crossover	10.2			10	2
Tollgate Road	N W-E	Unrestricted Kerb	4.7			0	0
Tollgate Road	N W-E	Crossover	4.7			0	0
Tollgate Road	N W-E	Unrestricted Kerb	8.9			5	1
Tollgate Road	N W-E	Crossover	6.1			5	1
Tollgate Road	N W-E	Unrestricted Kerb	3.1			0	0
Tollgate Road	N W-E	Crossover	5.6			5	1
Tollgate Road	N W-E	Unrestricted Kerb	20.1			20	4
Tollgate Road	N W-E	Crossover	5.2			5	1
Tollgate Road	N W-E	Unrestricted Kerb	1.8			0	0
Tollgate Road	N W-E	Crossover	4.8			0	0
Tollgate Road	N W-E	Unrestricted Kerb	3.8			0	0
Tollgate Road	N W-E	Crossover	5.6			5	1
Tollgate Road	N W-E	Unrestricted Kerb	1.9			0	0
Tollgate Road	N W-E	Crossover	4.7			0	0
Tollgate Road	N W-E	Unrestricted Kerb	2.8			0	0
Tollgate Road	N W-E	Crossover	6.4			5	1
Tollgate Road	N W-E	Unrestricted Kerb	52.7			50	10
Tollgate Road	N W-E	Crossover	8.2			5	1
Tollgate Road	S E-W	Too Narrow to Park	10.8			10	2
Tollgate Road	S E-W	Crossover	6.6			5	1
Tollgate Road	S E-W	Too Narrow to Park	7.4			5	1
Tollgate Road	S E-W	Crossover	6.9			5	1
Tollgate Road	S E-W	Too Narrow to Park	9.3			5	1
Tollgate Road	S E-W	Crossover	13.1			10	2
Tollgate Road	S E-W	Too Narrow to Park	17			15	3
Tollgate Road	S E-W	Crossover	6.5			5	1
Tollgate Road	S E-W	Too Narrow to Park	4.3			0	0
Tollgate Road	S E-W	Crossover	12.2			10	2
Tollgate Road	S E-W	Too Narrow to Park	10.1			10	2
Tollgate Road	S E-W	Crossover	8.4			5	1
Tollgate Road	S E-W	Too Narrow to Park	5.7			5	1
Tollgate Road	S E-W	Crossover	4.8			0	0
Tollgate Road	S E-W	Too Narrow to Park	14.6			10	2
Tollgate Road	S E-W	Crossover	5.6			5	1
Tollgate Road	S E-W	Too Narrow to Park	14.5			10	2
Tollgate Road	S E-W	Crossover	9.3			5	1

Tollgate Road	S E-W	Too Narrow to Park	12.2			10	2
Tollgate Road	S E-W	Crossover	8.4			5	1
Tollgate Road	S E-W	Too Narrow to Park	10.9			10	2
Tollgate Road	S E-W	Crossover	7.4			5	1
Tollgate Road	S E-W	Too Narrow to Park	10.4			10	2
Tollgate Road	S E-W	Crossover	8.5			5	1
Tollgate Road	S E-W	Too Narrow to Park	8.4			5	1
Tollgate Road	S E-W	Crossover	8.5			5	1
Tollgate Road	S E-W	Too Narrow to Park	6.6			5	1
Tollgate Road	S E-W	Crossover	9.4			5	1
Tollgate Road	S E-W	Too Narrow to Park	8.3			5	1
Tollgate Road	S E-W	Crossover	6.7			5	1
Tollgate Road	S E-W	Too Narrow to Park	9.2			5	1
Tollgate Road	S E-W	Crossover	7.5			5	1
Tollgate Road	S E-W	Too Narrow to Park	15			15	3
Tollgate Road	S E-W	Crossover	8.4			5	1

Appendix 5 – Walking Isochrones

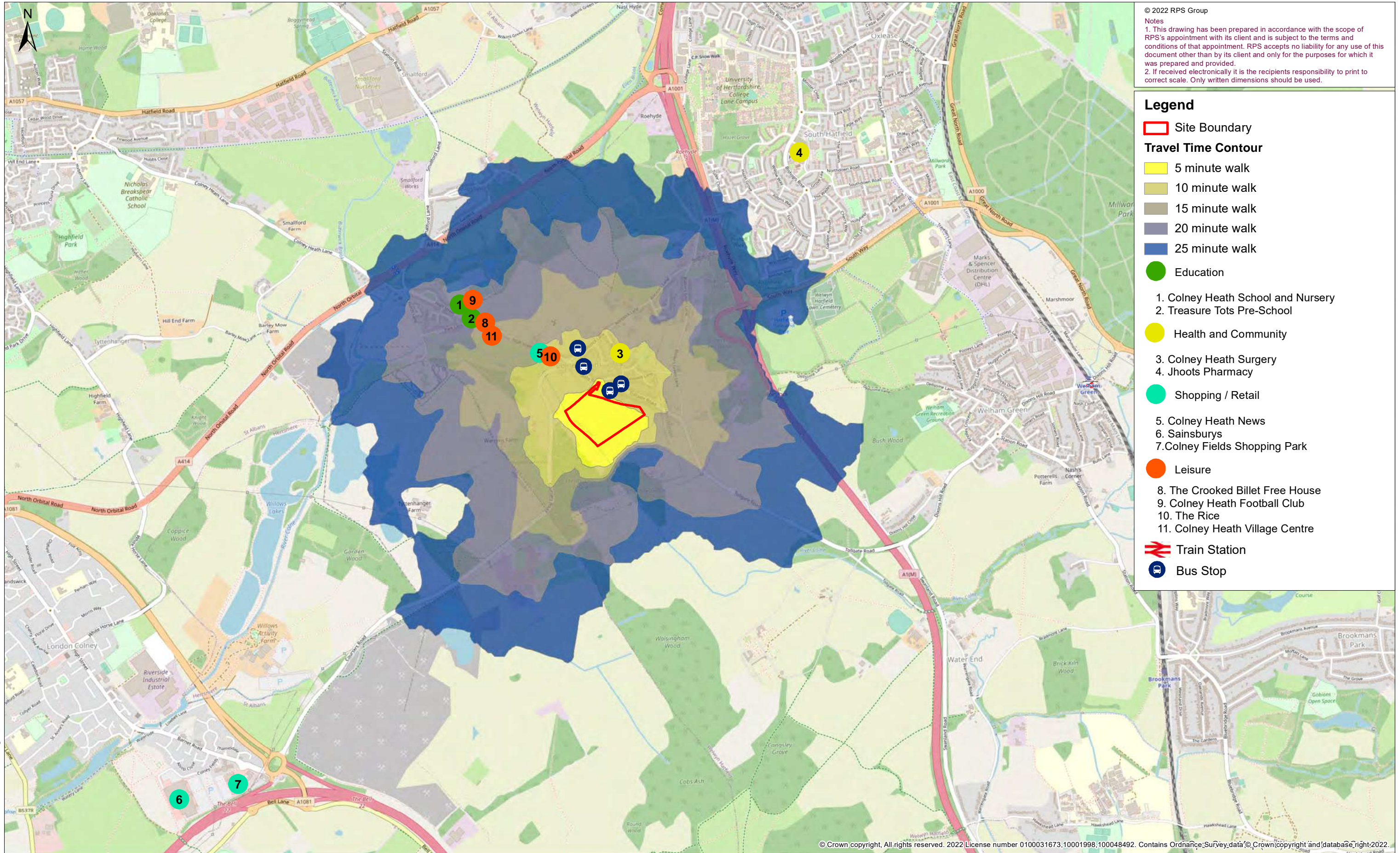

© 2022 RPS Group
 Notes
 1. This drawing has been prepared in accordance with the scope of RPS's appointment with its client and is subject to the terms and conditions of that appointment. RPS accepts no liability for any use of this document other than by its client and only for the purposes for which it was prepared and provided.
 2. If received electronically it is the recipient's responsibility to print to correct scale. Only written dimensions should be used.

- Legend**
- Site Boundary
 - Travel Time Contour**
 - 5 minute walk
 - 10 minute walk
 - 15 minute walk
 - 20 minute walk
 - 25 minute walk
 - Education
 - Health and Community
 - Shopping / Retail
 - Leisure
 - ⚡ Train Station
 - 🚌 Bus Stop
1. Colney Heath School and Nursery
 2. Treasure Tots Pre-School
 3. Colney Heath Surgery
 4. Jhoots Pharmacy
 5. Colney Heath News
 6. Sainsburys
 7. Colney Fields Shopping Park
 8. The Crooked Billet Free House
 9. Colney Heath Football Club
 10. The Rice
 11. Colney Heath Village Centre

© Crown copyright. All rights reserved. 2022 License number 0100031673;10001998;100048492. Contains Ordnance Survey data © Crown copyright and database right 2022.

\\eur-mpis-02\Projects\TRANSPORT\JNY11289\Tech\Drawings\11289-0002-02.mxd

Rev	Description	By	CB	Date
Figure Number				Rev
2				-
rpsgroup.com				

Client **Vistry Group**

Project **Colney Heath**

Title **Pedestrian Isochrone and Local Facilities Plan**

0 250 500 m

Note:
 Total end to end journey time using Basemap TRACC with Walk speed of 1.33m/s (4.8km/hr)

Status **FINAL**

Drawn By **CR**

PM/Checked By **LS**

Project Number **JNY11289**

Scale @ A3 **1:20,000**

Date Created **MAY 2022**

20 Western Avenue, Milton Park,
 Abingdon, Oxfordshire, OX14 4SH
 T: +44(0)1235 821 888
 E: rps@rpsgroup.com

MAKING COMPLEX EASY

Appendix 6 – Cycle Isochrones

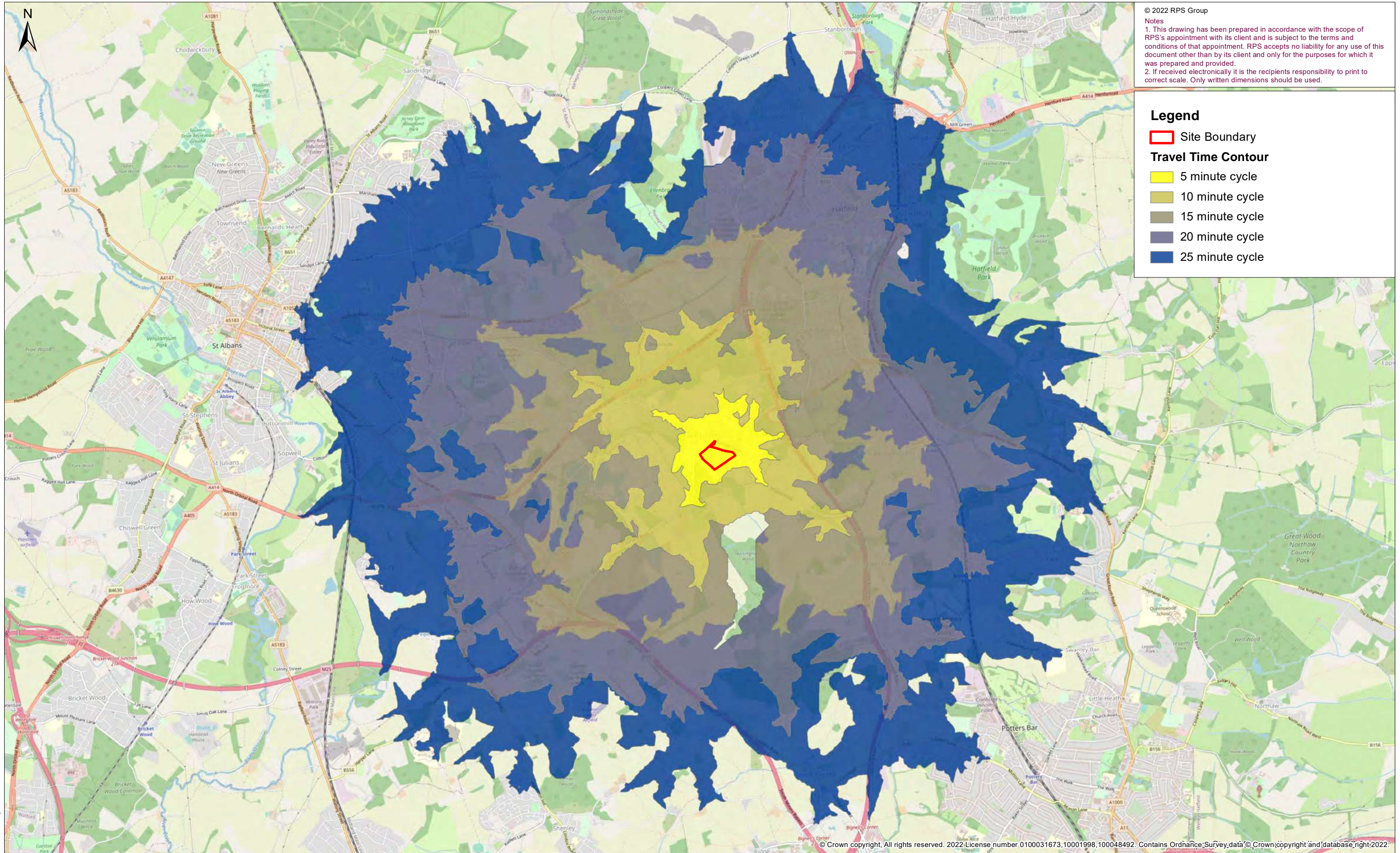

© 2022 RPS Group
 Notes
 1. This drawing has been prepared in accordance with the scope of RPS's appointment with its client and is subject to the terms and conditions of that appointment. RPS accepts no liability for any use of this document other than by its client and only for the purposes for which it was prepared and provided.
 2. If received electronically it is the recipient's responsibility to print to correct scale. Only written dimensions should be used.

Legend

- Site Boundary
- Travel Time Contour**
- 5 minute cycle
- 10 minute cycle
- 15 minute cycle
- 20 minute cycle
- 25 minute cycle

© Crown copyright. All rights reserved. 2022 License number 0100031673,10001998,100048492. Contains Ordnance Survey data © Crown copyright and database right 2022.

O:_TRANSPORT\JNY11289\TechDrawings\11289-0003-01.mxd

Rev	Description	By	CB	Date
Figure Number				Rev
3				-
rpsgroup.com				

Client **Vistry Group**

Project **Colney Heath**

Title **Cycle Isochrone Plan**

0 500 1,000 m

Note:
 Total end to end journey time using
 Basemap TRACC
 with Cycle speed of 16km/hr

Status **FINAL**

Project Number **JNY11289**

Scale @ A3 **1:45,000**

Drawn By **CR**

Scale @ A3 **1:45,000**

PM/Checked By **LS**

Date Created **JAN 2022**

20 Western Avenue, Milton Park,
 Abingdon, Oxfordshire, OX14 4SH
 T: +44(0)1235 821 888
 E: rps@rpsgroup.com



Appendix 7 – Bus Route Plan

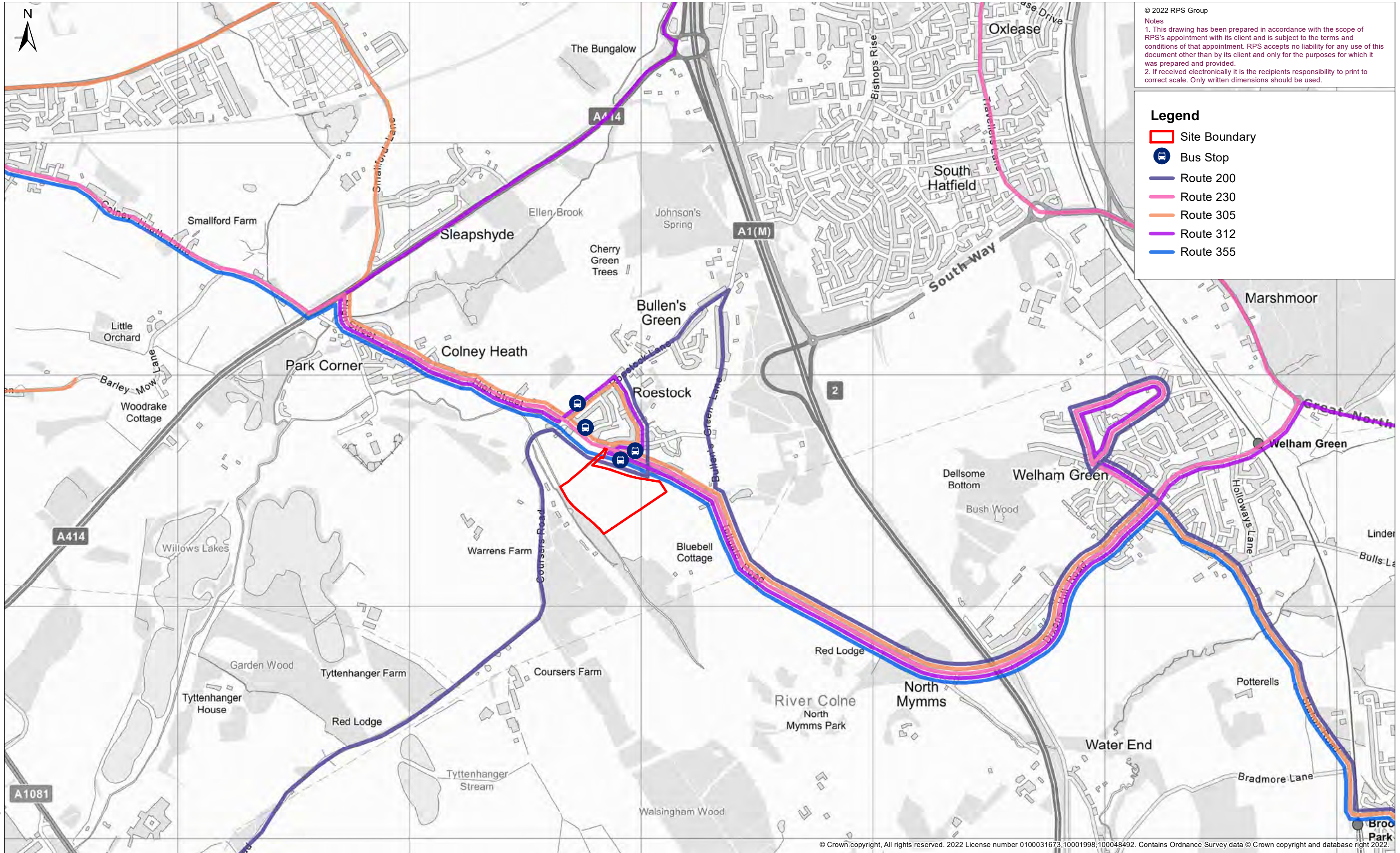

O:_TRANSPORT\JNY11289\TechDrawings\11289-0004-01.mxd

Rev	Description	By	CB	Date
4	Figure Number			Rev
				-

rpsgroup.com

Client	Vistry Group
Project	Colney Heath
Title	Bus Route Plan

0 250 500 m

Status	FINAL	Drawn By	CR	PM/Checked By	LS
Project Number	JNY11289	Scale @ A3	1:15,000	Date Created	JAN 2022

20 Western Avenue, Milton Park, Abingdon, Oxfordshire, OX14 4SH
 T: +44(0)1235 821 888
 E: rps@rpsgroup.com

MAKING COMPLEX EASY

© Crown copyright, All rights reserved. 2022 License number 0100031673,10001998,100048492. Contains Ordnance Survey data © Crown copyright and database right 2022.

Appendix 8 – Master Plan



Site Boundary: 7.82ha

Developable Area

Proposed residential area: 3.75ha
(Up to 150 dwellings @ 40 dph)

Movement & Circulation

- Proposed primary vehicular access point
- Proposed spine street through the development
- Proposed secondary streets
- Proposed lanes and private drives
- Recreational routes and Trim-Trail Stations
- Mown paths
- Potential pedestrian links
- Public Rights of Way

Green & Blue Infrastructure

- Public open space to serve the new development
- Avenue street tree planting
- Proposed new boundary hedgerow planting
- Proposed play provision for children and young people
- Proposed sustainable drainage basins and swales (SuDS)
- Existing vegetation
- Potential seating/picnic area
- Proposed location for pumping station and 15m cordon sanitaire

Surrounding Context

- Existing waterbodies and water courses
- Listed Buildings
- Colney Heath Local Nature Reserve
- Existing bus route and bus stops

Rev	Date	By	Description
A	16/06/2022	KP	Pumping station added, landscaping within LWS amended

CSA environmental

Dixies Barns, High Street,
Ashwell, Hertfordshire SG7 5NT

01462 743647
ashwell@csaenvironmental.co.uk
csaenvironmental.co.uk

Project Land at Tollgate Road
COLNEY HEATH

Title Concept Masterplan

Client Vistry Group

Scale	1:2500 @ A3	Drawn	KP
Date	June 2022	Checked	JC
Drawing No.	CSA/3925/117	Rev	A

Appendix 9 – Site Access Drawing

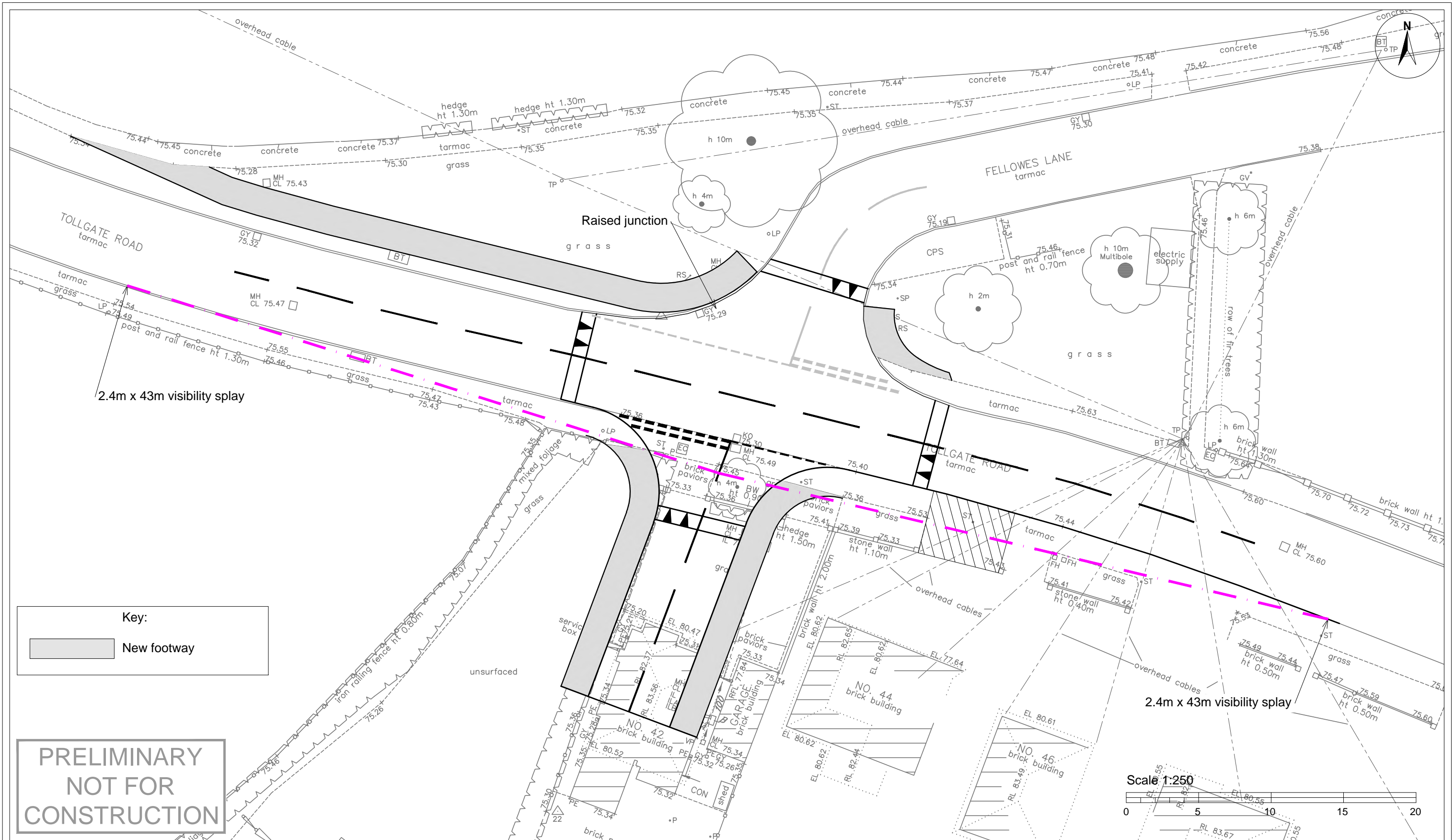

Key:
 New footway

**PRELIMINARY
NOT FOR
CONSTRUCTION**



20 Farringdon Street, London EC4A 4AB
 T: +44(0)20 3691 0500 E: transport@rpsgroup.com

Client Vistry Group
 Project Colney Heath
 Title Proposed Access Layout

© 2019 RPS Group
NOTES
 1. This drawing has been prepared in accordance with the scope of RPS's appointment with its client and is subject to the terms and conditions of that appointment. RPS accepts no liability for any use of this document other than by its client and only for the purposes for which it was prepared and provided.
 2. If received electronically it is the recipients responsibility to print to correct scale. Only written dimensions should be used.
 3. This drawing is to be read in conjunction with all relevant scheme drawings.

A	Updated Highway Boundary	GM	MSB	27.06.22
Rev	Description	By	CB	Date

Status	Drawn By	PM/Checked by
PRELIMINARY	AJ	MSB
Project Number	Scale @ A3	Date Created
JNY11289	1:250	29/04/22
RPS Drawing/Figure Number	Rev	
JNY11289-RPS-0100-001	A	

rpsgroup.com

Appendix 10 – Swept Path Analysis

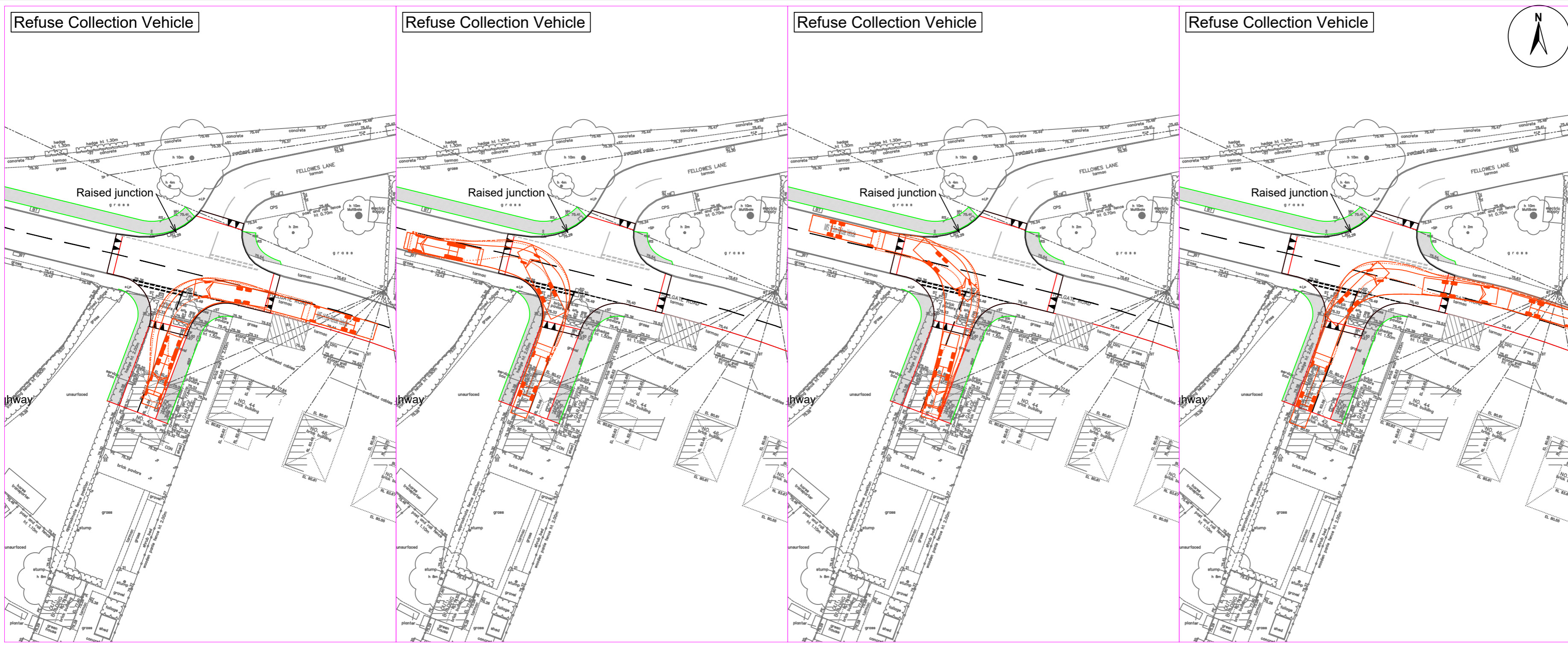

© 2019 RPS Group
 NOTES
 1. This drawing has been prepared in accordance with the scope of RPS's appointment with its client and is subject to the terms and conditions of that appointment. RPS accepts no liability for any use of this document other than by its client and only for the purposes for which it was prepared and provided.
 2. If received electronically it is the recipients responsibility to print to correct scale. Only written dimensions should be used.
 3. This drawing is to be read in conjunction with all relevant scheme drawings.

Vehicle Profile

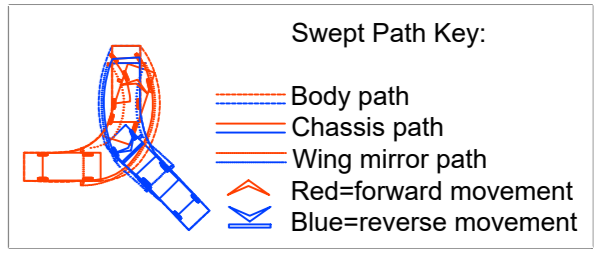
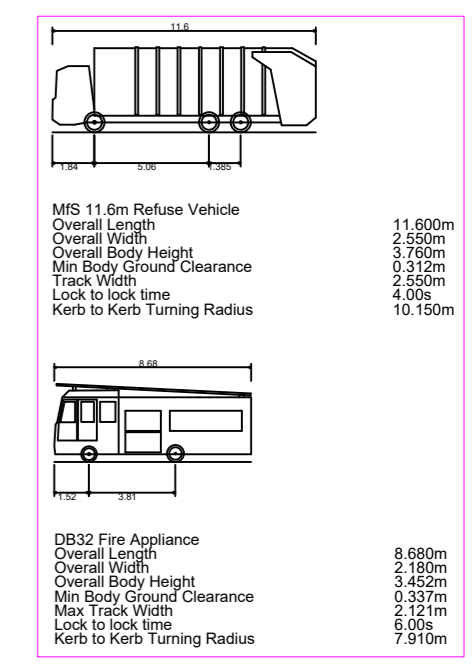

**PRELIMINARY
 NOT FOR
 CONSTRUCTION**

A	Minor Amendments	GM	MSB	27.06.22
Rev	Description	By	CB	Date

rps MAKING COMPLEX EASY
 20 Farrington Street, London EC4A 4AB
 T: +44(0)20 3691 0500 E: transport@rpsgroup.com

Client **Virtry Group**

Project **Colney Heath**

Title **Refuse Vehicle & Fire Appliance Swept Path Analysis**

Status	Drawn By	PM/Checked by
INFORMATION	AJ	MSB
Project Number	Scale @ A2	Date Created
JNY11289	1:500	26/05/22
RPS Drawing/Figure Number	Rev	
JNY11289-RPS-0100-002	A	

rpsgroup.com

Appendix 11 – RSA1 Designer’s Response

**TOLLGATE ROAD
COLNEY HEATH
HERTFORDSHIRE
PROPOSED RESIDENTIAL DEVELOPMENT
ACCESS ARRANGEMENT**

**Stage 1 Road Safety Audit
Designers Response**

JNY11289-03
Designers Response
Version -
25 May 2022

Document Status

Version	Purpose of document	Authored by	Reviewed by	Approved by	Review date
-	Information	Matthew Brown	Ian Dimbylow	Ian Dimbylow	25 May 2022

This report was prepared by **RPS Consulting Services Ltd** ('RPS') within the terms of its engagement and in direct response to a scope of services. This report is strictly limited to the purpose and the facts and matters stated in it and does not apply directly or indirectly and must not be used for any other application, purpose, use or matter. In preparing the report, RPS may have relied upon information provided to it at the time by other parties. RPS accepts no responsibility as to the accuracy or completeness of information provided by those parties at the time of preparing the report. The report does not take into account any changes in information that may have occurred since the publication of the report. If the information relied upon is subsequently determined to be false, inaccurate or incomplete then it is possible that the observations and conclusions expressed in the report may have changed. RPS does not warrant the contents of this report and shall not assume any responsibility or liability for loss whatsoever to any third party caused by, related to or arising out of any use or reliance on the report howsoever. No part of this report, its attachments or appendices may be reproduced by any process without the written consent of RPS. All enquiries should be directed to RPS.

Prepared by:

Prepared for:

RPS Consulting Services Ltd

Vistry Group

Matthew Brown
Associate - Transport

20 Farringdon Street, London EC4A 4AB



1 INTRODUCTION

- 1.1 This Road Safety Audit Designer's Response relates to the Stage 1 Road Safety Audit carried out on a proposed access arrangement with Tollgate Road, Colney Heath to serve a proposed residential development. The Stage 1 Road Safety Audit (RSA) was undertaken by Taylor Bowie Ltd on 19 May 2022 in accordance with GG119 'Road Safety Audit'. The Stage 1 RSA is provided at **Appendix 1**.
- 1.2 The Design Team have considered the problems and recommendations in the Stage 1 Road Safety Audit and provided the following responses.

Audit	Problem Summary and Recommendation	Designers Response
3.2	<p>Location: Vertical traffic calming measures</p> <p>Summary: Insufficient drainage may increase the risk of flooding and single vehicle loss of control type collisions.</p> <p>At this stage of audit drainage proposals have not been provided. A lack of appropriate drainage at the location of the proposed vertical traffic calming feature may increase the risk of flooding in this area which may result in an increased risk of single vehicle loss of control type collisions.</p> <p>Recommendation: The Audit Team recommend that appropriate drainage is incorporated into the scheme proposals.</p>	<p>The problem is accepted.</p> <p>This issue will be addressed at the Section 278 detailed design stage and can be reviewed as part of the Stage 2 Road Safety Audit.</p>
3.3	<p>Location: Access junctions</p> <p>Summary: Increased risk of kerb strikes.</p> <p>At this stage of audit, vehicle swept paths have not been provided. Without this information it is unclear whether the relevant design vehicles can safely carry out their turning movements without hitting kerbs / overrunning verge areas. This may increase the risk of kerb strikes.</p> <p>Recommendation: The Audit Team recommends that vehicle swept paths are carried out to confirm that vehicles can safely negotiate all expected movements.</p>	<p>The problem is accepted.</p> <p>The proposed access arrangement has been subject to swept path analysis for the largest design vehicle (a large refuse vehicle). The swept path analysis is provided at Appendix 2 and confirms that the proposed access can accommodate the largest design vehicle.</p>

Audit	Problem Summary and Recommendation	Designers Response
<p>3.4</p>	<p>1. Location: proposed raised table feature.</p> <p>Summary: Lack of pedestrian provision may result in pedestrian to vehicle collisions</p> <p>The drawing indicates that new lengths of footway provision are to be incorporated into the scheme proposals on both the northern and southern side of Tollgate Road. Tactile paving is not shown at either location. This may increase the risk of vehicle to pedestrian type collisions.</p> <p>Recommendation: The Audit Team recommends that appropriate tactile paving is provided</p>	<p>The problem is accepted.</p> <p>This issue will be addressed at the Section 278 detailed design stage and can be reviewed as part of the Stage 2 Road Safety Audit.</p>
	<p>2. Location: Fellowes Lane</p> <p>Summary: Reduced pedestrian to driver intervisibility may increase the risk of vehicle to pedestrian type collisions.</p> <p>The drawings indicate that a new length of footway is proposed around the eastern radii of Fellowes Lane together with a new section on the western side which ties into existing facility further west.</p> <p>At the time of the site visit it was noted that there was significant on-street parking along the northern side of Fellowes Lane and on the grass-crete area on the southern side of Fellowes Lane.</p>	<p>This problem is partially accepted.</p> <p>Vehicles approaching the Fellowes Lane give-way line will be travelling slowly. The proposed raised table junction will also physically enforce low vehicle speeds on the approach to the east / west pedestrian crossing on Fellowes Lane. Based on the low-speed approach to the Fellowes Lane pedestrian and give way with Tollgate Road it is considered that there should be enough intervisibility between pedestrians and vehicles.</p> <p>In addition, drivers of vehicles are required to be prepared to stop and give-way to vulnerable road users and no longer have priority at junctions as part of the recent changes to the highway code. The raised tabled junction provides an at grade crossing for pedestrians and reinforces the pedestrian's priority.</p>

Audit	Problem Summary and Recommendation	Designers Response
	<p>Furthermore, beyond the grass-crete area, there was overgrown vegetation along the southern side of the carriageway. Pedestrians crossing from either footway will have a reduced visibility to the right due to the existing parking and vegetation. A lack of adequate visibility at this crossing point may increase the risk of vehicle to pedestrian type collisions.</p> <p>Recommendation: The Audit Team recommends that the driver to pedestrian intervisibility is not compromised by the presence of parked vehicles and vegetation to the north / east of the crossing point.</p>	<p>The overgrown vegetation can also be cut back below 600mm to maximise the available inter visibility on the approach to the Fellowes Lane pedestrian crossing and give way.</p>
	<p>3. Location: Proposed raised table feature on Tollgate Road. Summary: Insufficient warning that drivers will be approaching a vertical feature – risk of single vehicle loss of control type collisions. As part of the scheme proposals, a raised feature is to be implemented across the junction of Tollgate Road and Fellowes Lane, forming a crossroads junction.</p> <p>There is no warning for drivers that they will be approaching an isolated traffic calming feature. This may result in vehicles approaching this vertical feature at an undesirable speed. This may increase the risk of single vehicle loss of control type collisions.</p> <p>Recommendation:</p> <p>The Audit Team recommends that clear warning of the raised feature is provided.</p>	<p>The problem is accepted.</p> <p>This advanced waring signage will be addressed at the Section 278 detailed design stage and can be reviewed as part of the Stage 2 Road Safety Audit.</p>

Design Organisation Statement

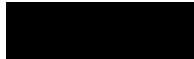
On behalf of the design organisation, I certify that:	
1) The RSA actions identified in response to the road safety audit problems in this road safety audit have been discussed and agreed with the Overseeing Organisation.	
Name	Matthew Brown
Signed	
Position	Associate
Organisation	RPS Consulting Services Ltd
Date	25 May 2022

Overseeing Organisation Statement

On behalf of the Overseeing Organisation, I certify that:	
1) The RSA actions identified in response to the road safety audit problems in this road safety audit have been discussed and agreed with the design organisation; and	
2) The agreed RSA actions will be progressed.	
Name	
Signed	
Position	
Organisation	HCC
Date	

Appendices

Appendix 1 – Stage 1 Road Safety Audit

**TOLLGATE ROAD, COLNEY HEATH
HERTFORDSHIRE**
Proposed Access Layout

Road Safety Audit - Stage 1

Final Report

May 2022

TBL19/301

REPORT APPROVAL

Project Details

Project Title	Tollgate Road, Colney Heath, Hertfordshire		
Project Subtitle	Proposed Access Layout		
Road Safety Audit	Stage 1		
Document Reference	TBL19/301	Audit Brief Date	19 th May 2022
Overseeing Organisation	Hertfordshire County Council		
Design Organisation	Matthew Brown	RPS	
Client	-	Vistry Group	
Maintaining Agent Details	-	-	

Approvals

This document requires the following approvals:

Name	Title
Sarah Bowie	Audit Team Leader
Mario Gatti	Audit Team Member

Distribution

This document has also been distributed to:

Name	Title & Organisation
Matthew Brown	Associate – RPS (Transport & Engineering)

1 INTRODUCTION

1.1 The Scheme and its Purpose

This report results from a Stage 1 Road Safety Audit (RSA) carried out on a proposed development junction on Tollgate Road, Colney Heath, Hertfordshire.

The works are associated with a residential development on land to the south of Tollgate Road and consist of a new raised table priority development access junction to serve circa 150 residential dwellings with new lengths of footway provision.

1.2 Terms of Reference & Audit Report

The Road Safety Audit Brief was approved and issued by Matthew Brown of the Design Organisation. The RSA team has been approved by the Design Organisation.

Table 1 - Audit Team Membership

Membership	Name	Details
Audit Team Leader	Sarah Bowie	IEng, MICE, FIHE, MCIHT, MSoRSA, HE RSA Cert Comp
Audit Team Member	Mario Gatti	BSc Civ Eng, MCIHT, MSoRSA, HE RSA Cert Comp

The Road Safety Audit was undertaken in accordance with the requirements of GG 119. No additional audit requirements were requested. The audit comprised of an examination of the brief and the documents provided to the Audit Team, listed in **Appendix A**.

The audit took place at Taylor Bowie Ltd Cambridgeshire office during May 2022 and both Audit Team Members examined the site together in daylight hours on the afternoon of 19th May 2022 between the times of 1230 and 1330hrs. The weather during the site visit was hot and sunny. The carriageway was dry. Traffic flows at all times were moderate. No pedestrians and no cyclists were observed during the site visit.

The scheme has been examined, and this report compiled only on the road safety implications of the scheme as presented and has not examined or verified the compliance of the designs to any other criteria.

No Departures from Standards (DfS) have been provided to the Audit Team. It is important that if there are any DfS, then they are submitted to the Overseeing Organisation (OO) as soon as possible with appropriate mitigating measures for the OO to approve. This may be particularly relevant with regard to the isolated raised junction where no speed reducing measures are proposed in advance of the feature.

All Problems and Recommendations are referenced to the design drawings and the locations have been indicated on the A4 plan supplied for use by the Audit Team in **Appendix B** (where applicable).

1.3 Audit Administration

Issues identified during the audit and site visit which the Terms of Reference exclude from this report, but which the audit team wishes to draw to the attention of the OO, will be set out in a separate letter. These issues could include maintenance items and operational issues.

The Audit Team have not identified any issues during this Stage 1 RSA and site visit that are considered to be outside the Terms of Reference.

2 ITEMS RAISED AT PREVIOUS ROAD SAFETY AUDITS

No previous Road Safety Audits have been undertaken on these proposals.

3 ITEMS RAISED AT THIS STAGE 1 ROAD SAFETY AUDIT

3.1 Local Alignment

No Problems identified in this category at this Stage 1 Road Safety Audit.

3.2 General

PROBLEM	General
Location	Vertical traffic calming measure (Drwg No. JNY11289-RPS-0100-001)
Summary	Insufficient drainage may increase the risk of flooding and single vehicle loss of control type collisions.
<p>At this stage of audit drainage proposals have not been provided. A lack of appropriate drainage at the location of the proposed vertical traffic calming feature may increase the risk of flooding in this area which may result in an increased risk of single vehicle loss of control type collisions.</p>	
RECOMMENDATION	
<p>The Audit Team recommend that appropriate drainage is incorporated into the scheme proposals.</p>	

3.3 Junctions

PROBLEM	General
Location	Access junctions – existing (Drwg No. JNY11289-RPS-0100-001)
Summary	Increased risk of kerb strikes.
<p>At this stage of audit, vehicle swept paths have not been provided. Without this information it is unclear whether the relevant design vehicles can safely carry out their turning movements without hitting kerbs/overrunning verge areas. This may increase the risk of kerb strikes.</p>	

RECOMMENDATION

The Audit Team recommends that vehicle swept paths are carried out to confirm that vehicles can safely negotiate all expected movements.

3.4 Walking, Cycling and Horse Riding

PROBLEM	1
Location	Proposed raised table feature (Drwg.no. JNY11289-RPS-0100-001)
Summary	Lack of pedestrian provision may result in pedestrian to vehicle collisions.
<p>The drawing indicates that new lengths of footway provision are to be incorporated into the scheme proposals on both the northern and southern side of Tollgate Road. Tactile paving is not shown at either location.</p> <p>This may increase the risk of vehicle to pedestrian type collisions.</p>	
RECOMMENDATION	
The Audit Team recommends that appropriate tactile paving is provided.	

PROBLEM	2
Location	Fellowes Lane (Drwg No. JNY11289-RPS-0100-001)
Summary	Reduced pedestrian to driver intervisibility may increase the risk of vehicle to pedestrian type collisions.
<p>The drawings indicate that a new length of footway is proposed around the eastern radii of Fellowes Lane together with a new section on the western side which ties into existing facility further west.</p> <p>At the time of the site visit it was noted that there was significant on-street parking along the northern side of Fellowes Lane and on the grass-crete area on the southern side of Fellowes Lane. Furthermore, beyond the grass-crete area, there was overgrown vegetation along the southern side of the carriageway. Pedestrians crossing from either footway will have a reduced visibility to the right due to the existing parking and vegetation. A lack of adequate visibility at this crossing point may increase the risk of vehicle to pedestrian type collisions.</p>	

RECOMMENDATION

The Audit Team recommends that the driver to pedestrian intervisibility is not compromised by the presence of parked vehicles and vegetation to the north/east of the crossing point.

3.5 Traffic Signs, Carriageway Markings and Lighting

PROBLEM	3
Location	Proposed raised table feature on Tollgate Road (Drwg No. JNY11289-RPS-0100-001)
Summary	Insufficient warning that drivers will be approaching a vertical feature - risk of single vehicle loss of control type collisions.
<p>As part of the scheme proposals, a raised feature is to be implemented across the junction of Tollgate Road and Fellowes Lanes, forming a crossroads junction.</p> <p>There is no warning for drivers that they will be approaching an isolated traffic calming feature. This may result in vehicles approaching this vertical feature at an undesirable speed. This may increase the risk of single vehicle loss of control type collisions.</p>	
RECOMMENDATION	
The Audit Team recommends that clear warning of the raised feature is provided.	

END OF PROBLEMS IDENTIFIED & RECOMMENDATIONS OFFERED IN THIS STAGE 1 ROAD SAFETY AUDIT

4 AUDIT TEAM STATEMENT

We certify that this Road Safety Audit has been carried out in accordance with GG 119.

AUDIT TEAM LEADER	
Name	Sarah Bowie - IEng, MICE, FIHE, MCIHT, MSoRSA, HE RSA Cert Comp
Signed	
Position	Director
Organisation	Taylor Bowie Ltd
Date	24 th May 2022

AUDIT TEAM MEMBER	
Name	Mario Gatti - BSc Civ Eng, MCIHT, MSoRSA, HE RSA Cert Comp
Signed	
Position	Associate Consultant
Organisation	Taylor Bowie Ltd
Date	24 th May 2022

APPENDIX A

Documents Forming the Audit Brief

Drawings:

DRAWING NO.	TITLE
JNY11289	Site Location Plan
JNY11289-RPS-0100-001	Proposed Access Layout

APPENDIX B

Problem Location Plan

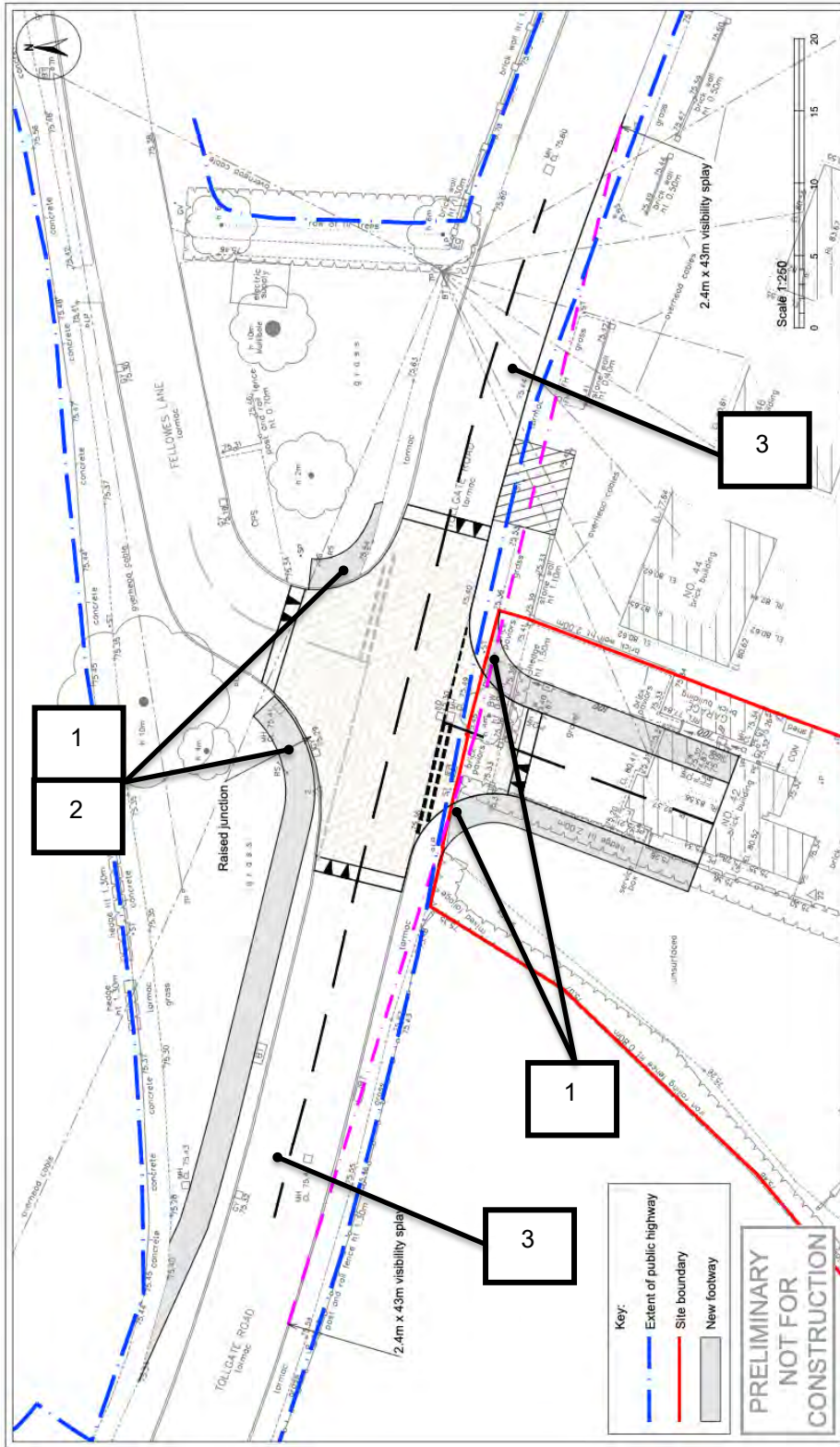

Status: PRELIMINARY
 Drawn By: AJ
 Project Number: JNY11289
 RPS Drawing/Program Number: JNY11289-RPS-0100-001
 Scale: A3
 Scale: 1:250
 Date Created: 29/04/22
 Rev: -
 PPI Checked by: MSB

Rev	Description	By	CD	Date

© 2019 RPS Group
NOTES
 1. This drawing has been prepared in accordance with the scope of RPS's appointment with its client and RPS shall have no liability for any use of this document other than by its client and only for the purposes for which it was prepared and provided.
 2. RPS Group does not accept any responsibility for the accuracy or completeness of the information contained in this document or for any omissions or errors. Only written dimensions should be used.
 3. This drawing is to be read in conjunction with all relevant scheme drawings.

Client: Vistry Group
 Project: Colney Heath
 Title: Proposed Access Layout

RPS
 RPS Group Limited
 23 Longwalk Road, Luton, LU14 5AB
 T: 01525 396200 E: rps@rpsgroup.com

Taylor Bowie Ltd
ROAD SAFETY & TRANSPORTATION CONSULTANCY

E: info@taylorbowie.co.uk

W: www.taylorbowie.co.uk

Appendix 2 – Swept Path Analysis

Refuse Collection Vehicle

Refuse Collection Vehicle

Refuse Collection Vehicle

Refuse Collection Vehicle

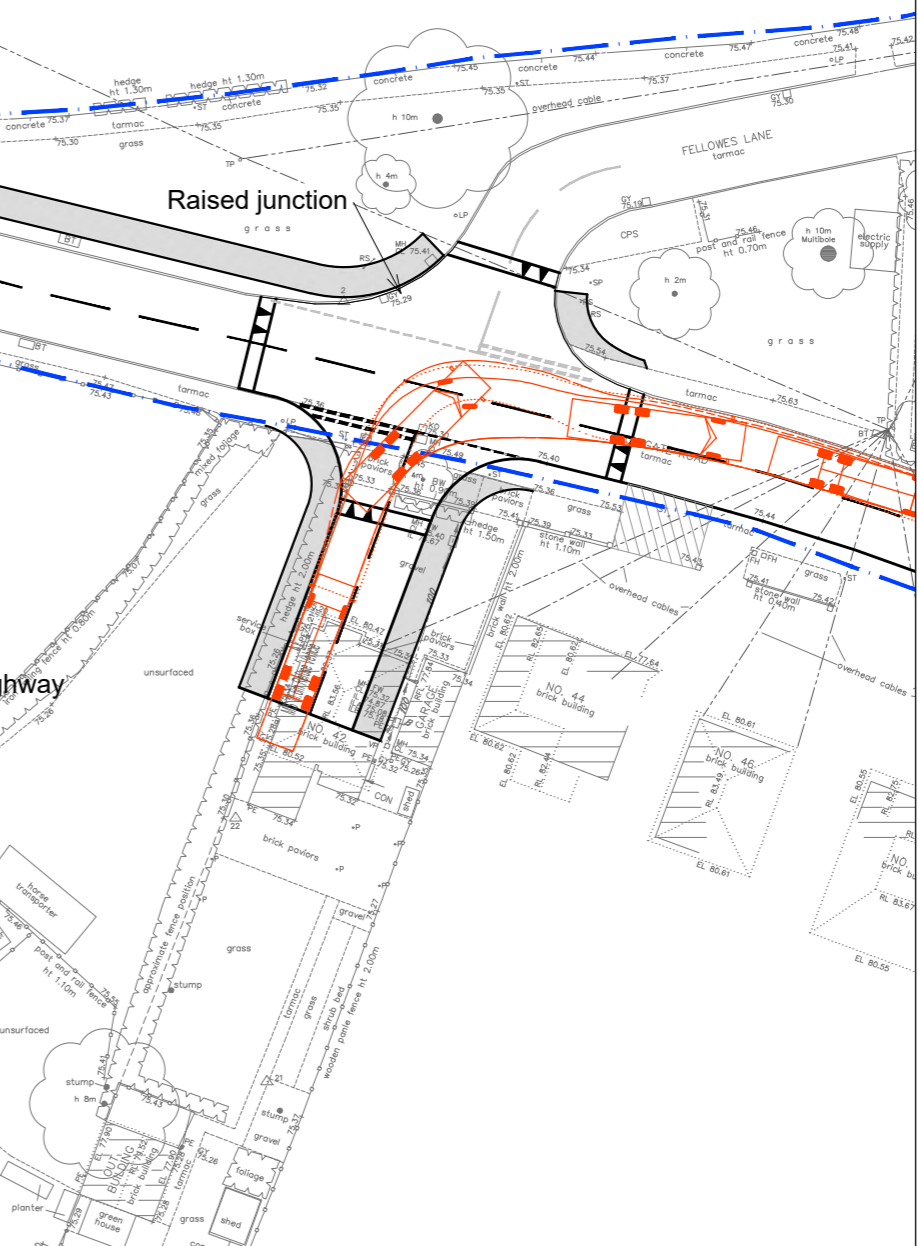
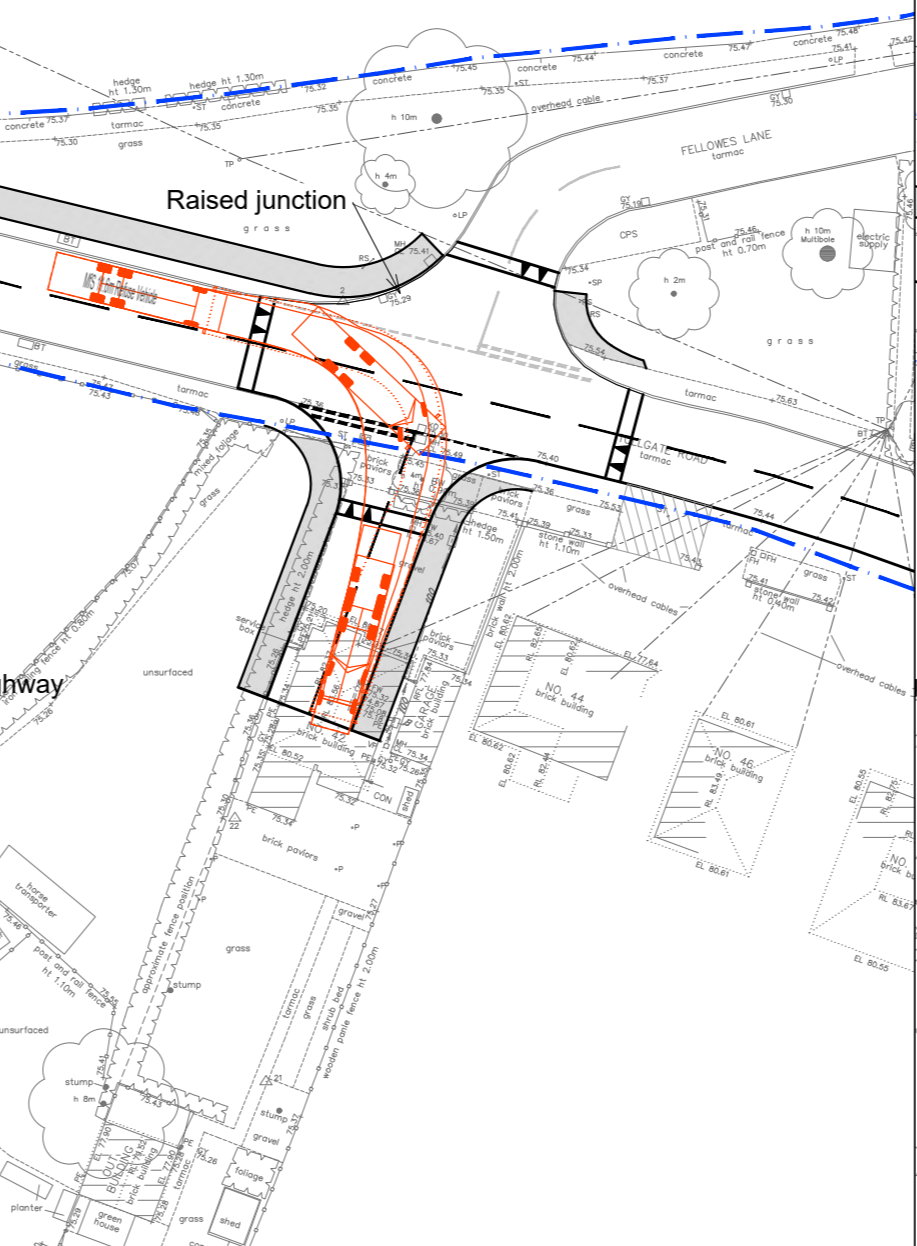
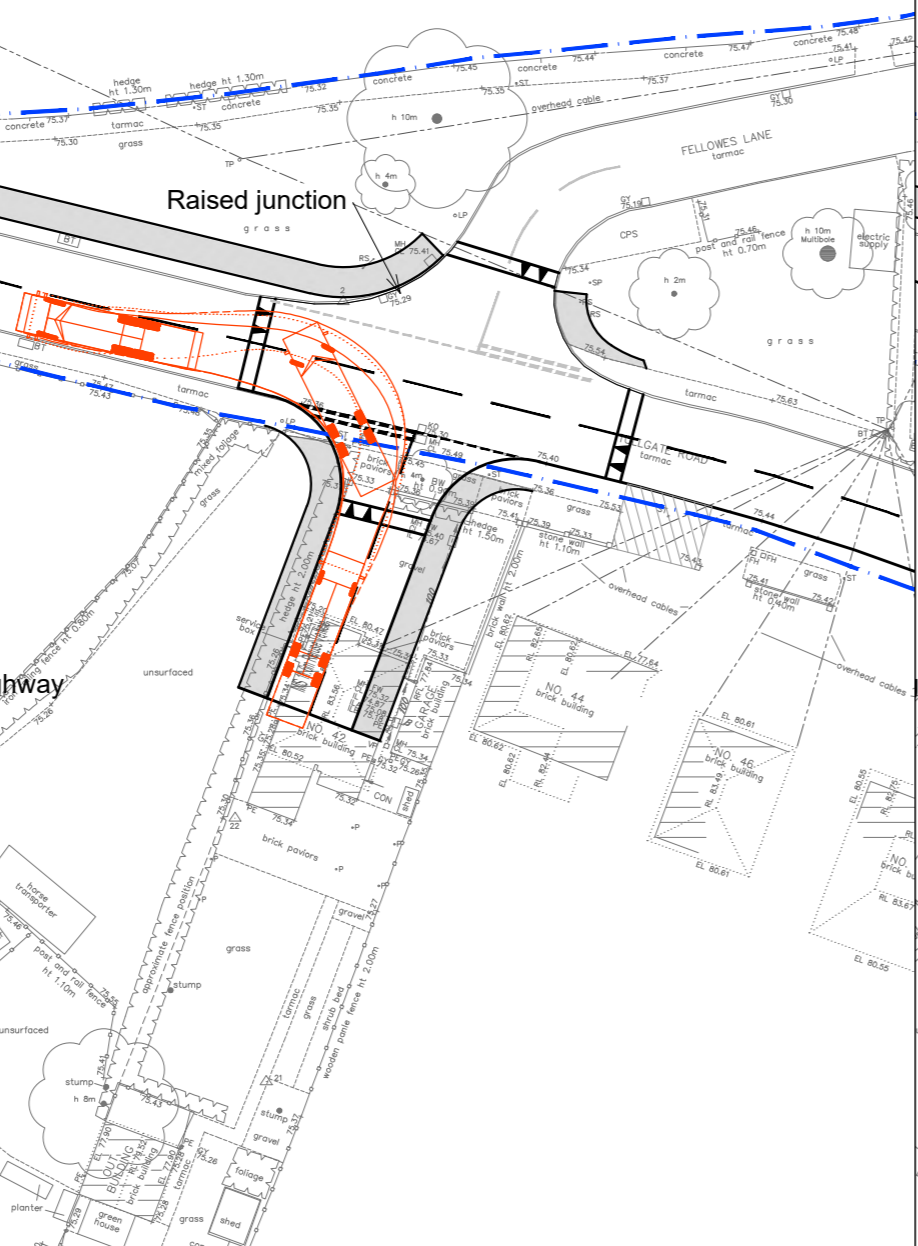
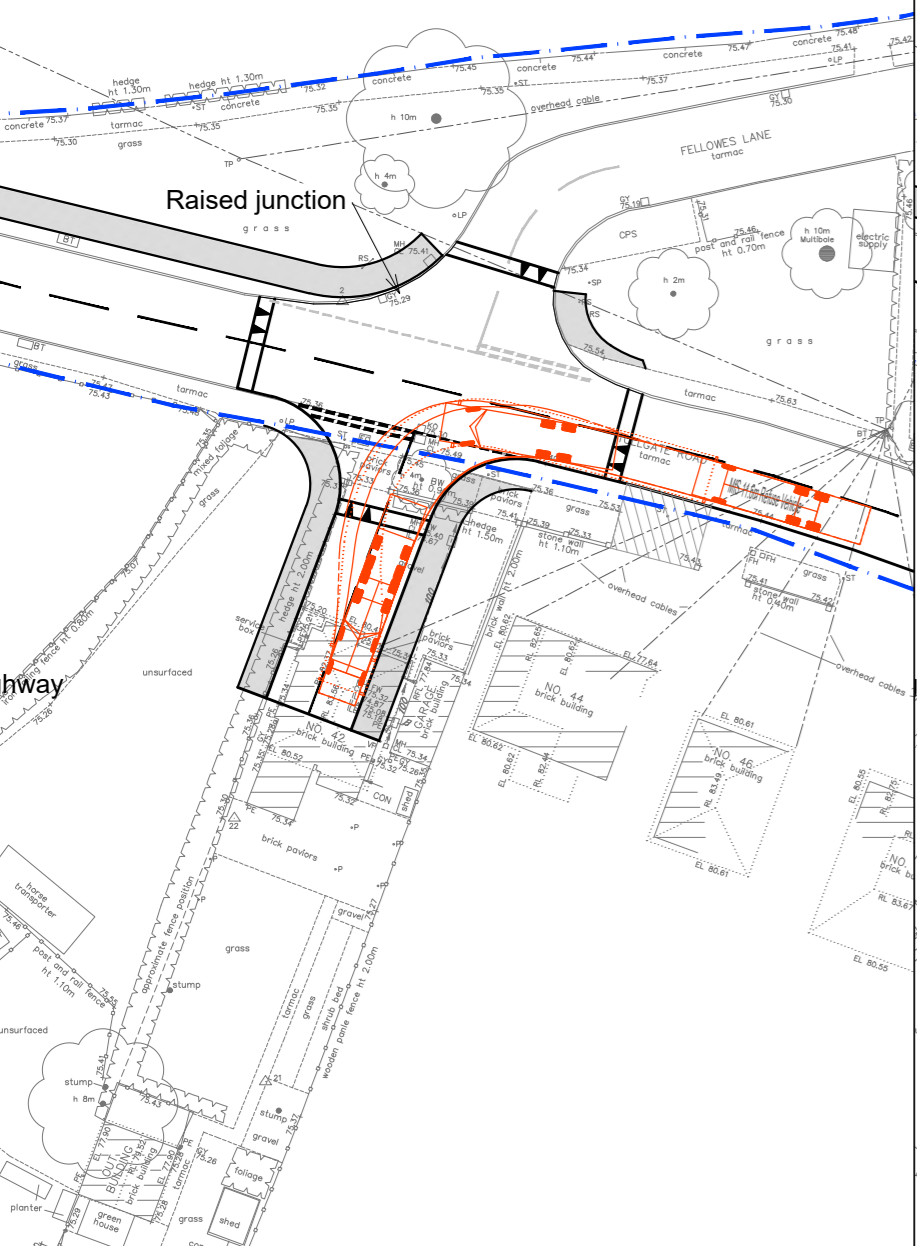

Fire Appliance

Fire Appliance

Fire Appliance

Fire Appliance

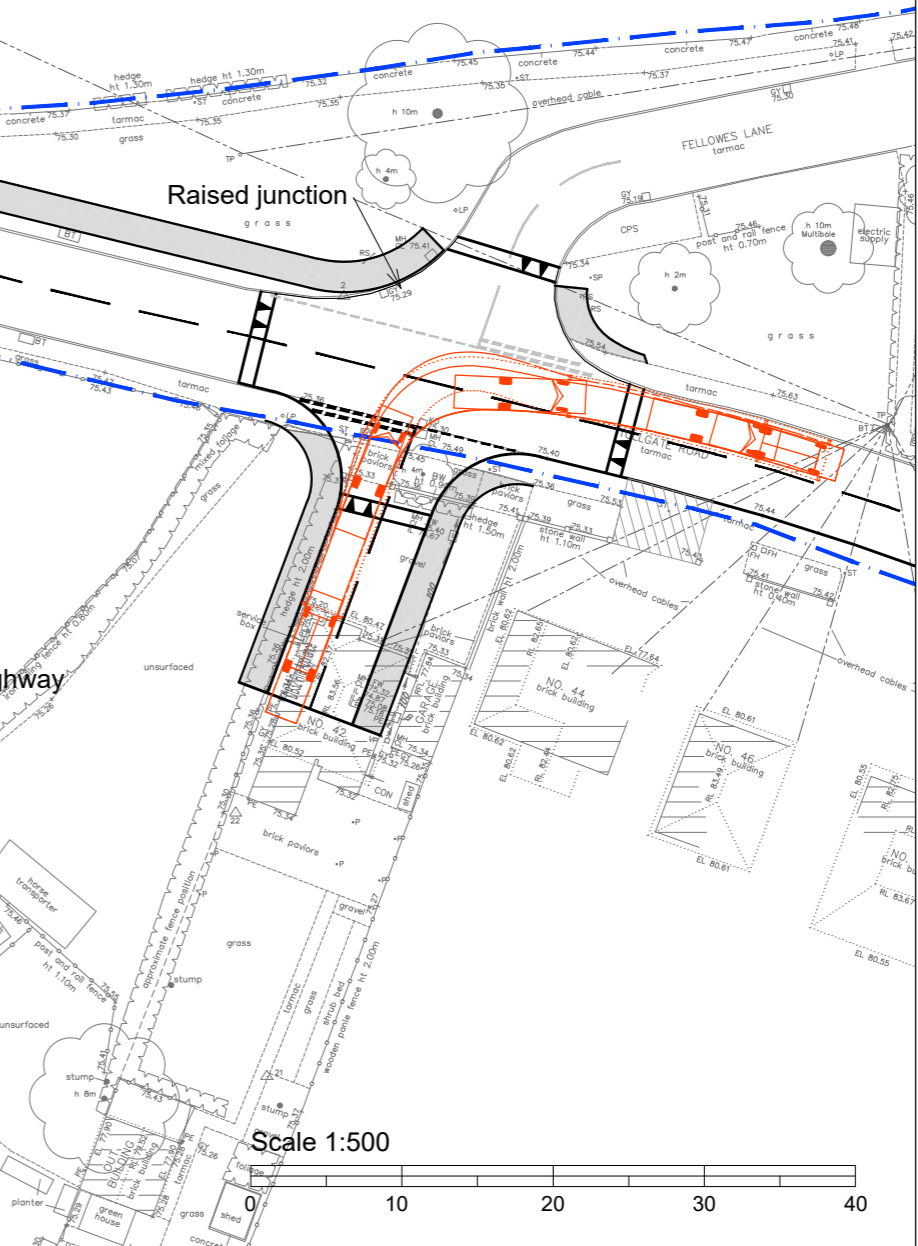
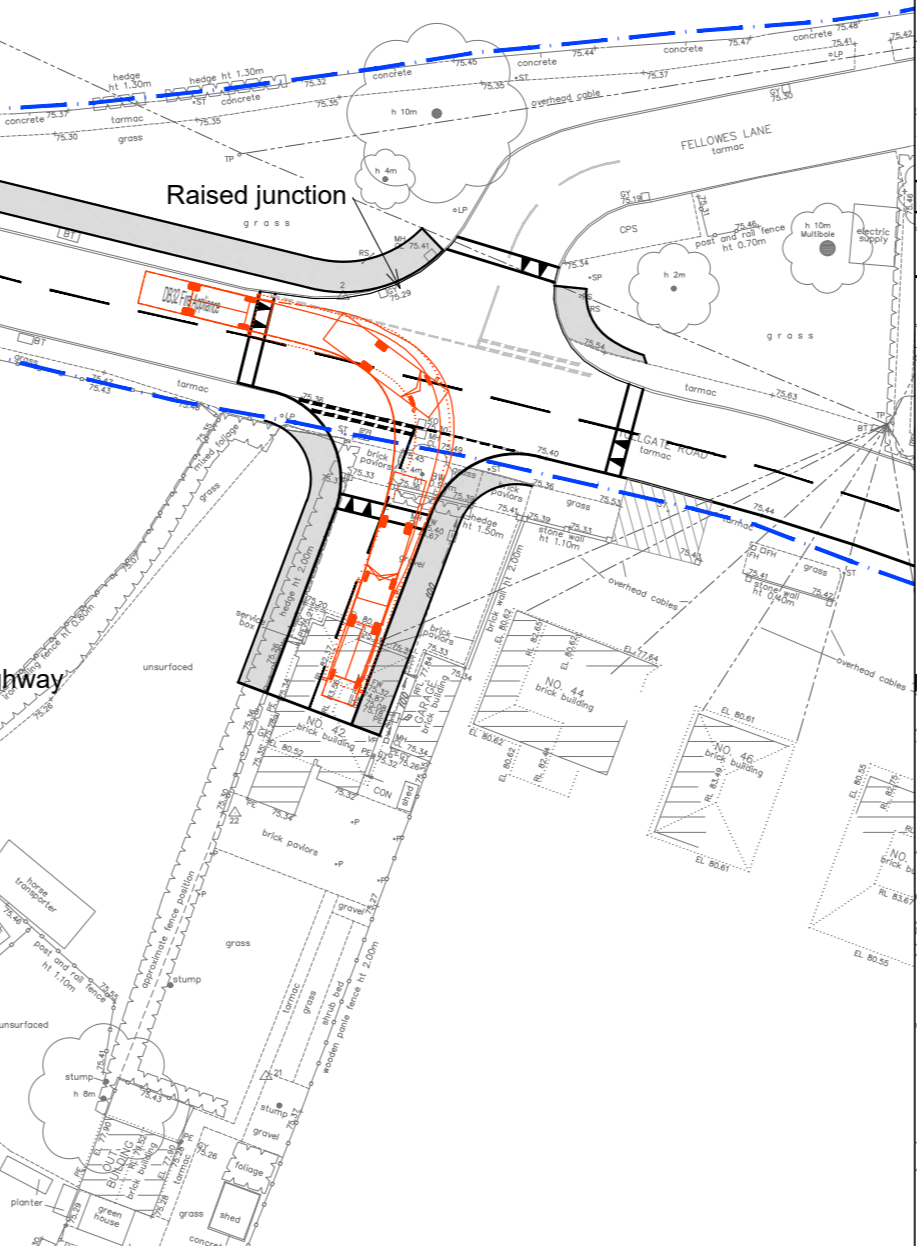
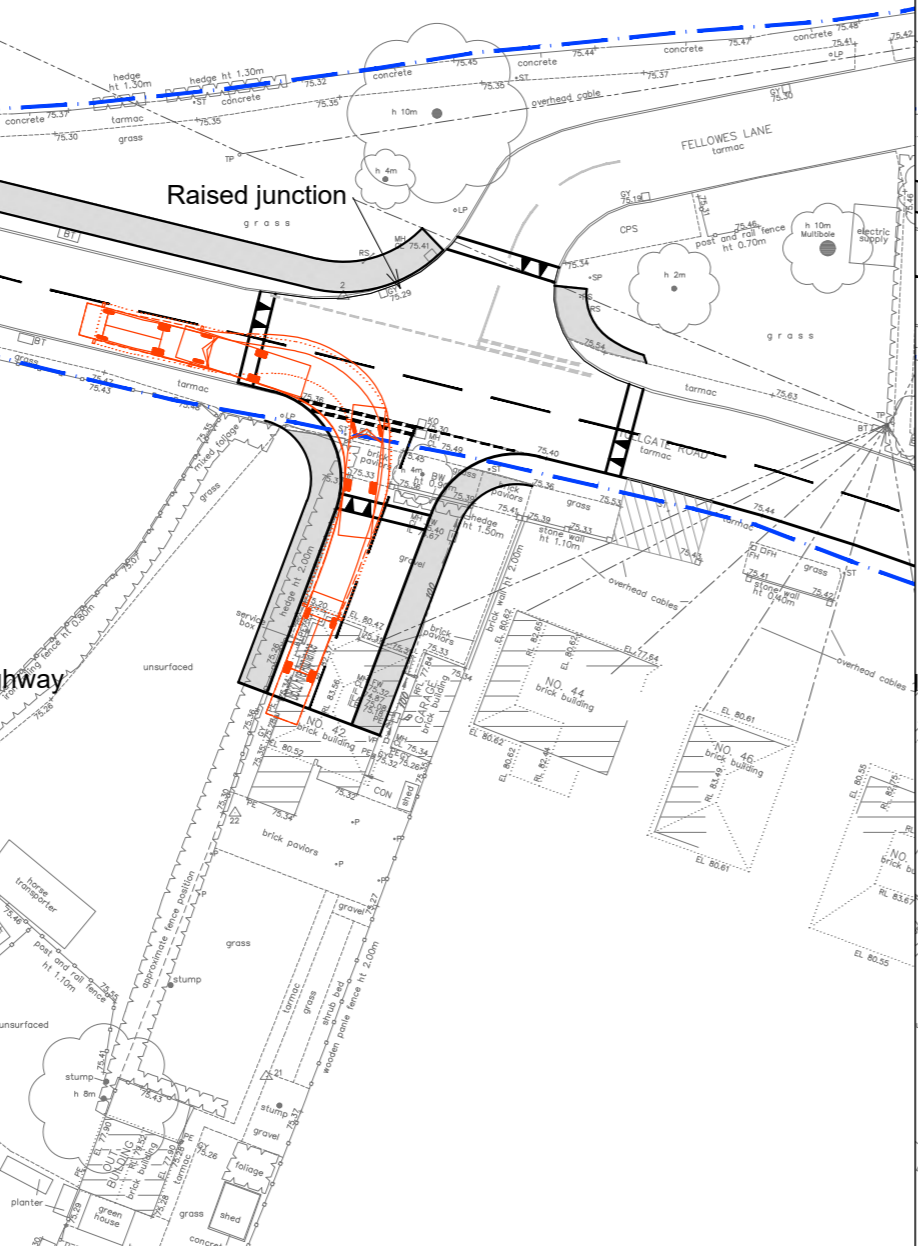
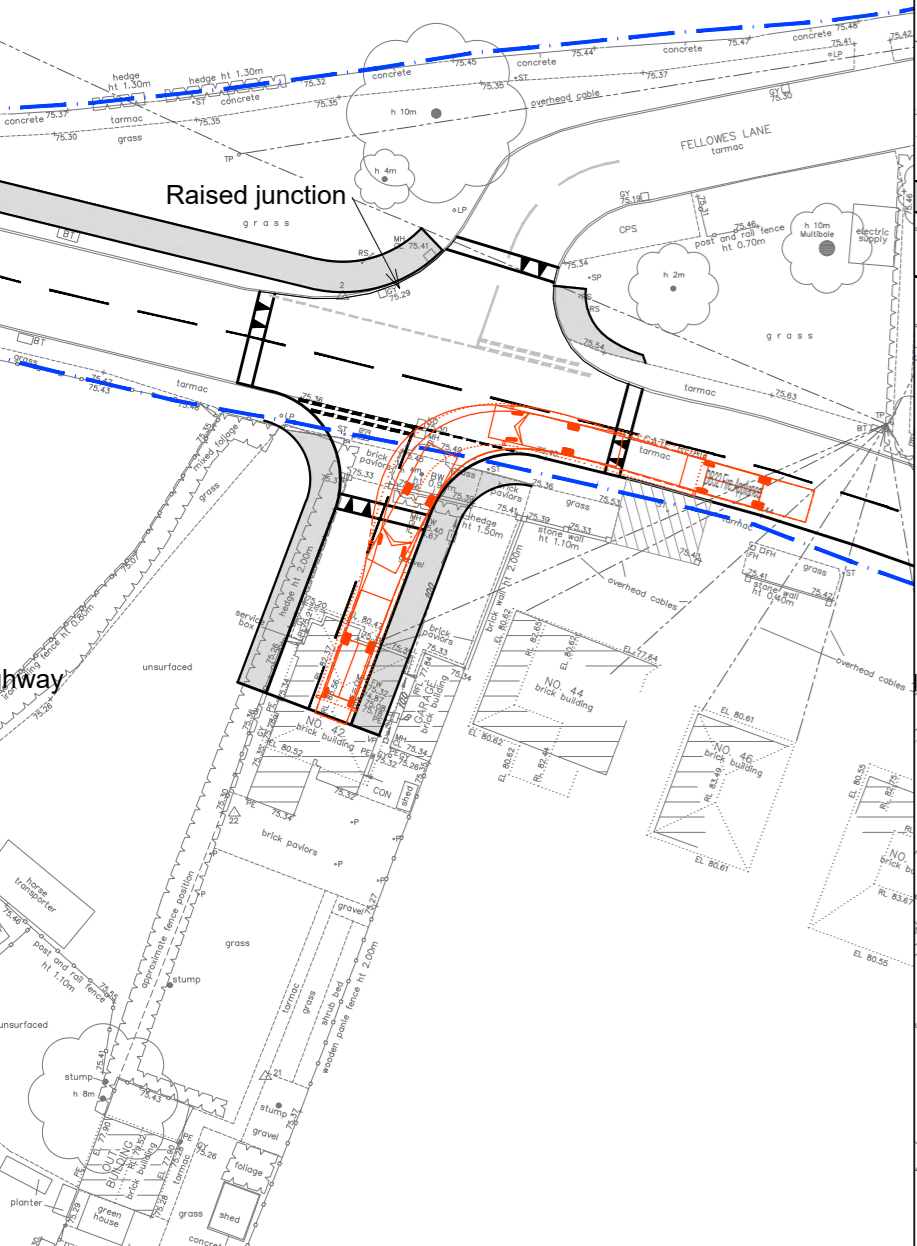

- © 2019 RPS Group
NOTES
1. This drawing has been prepared in accordance with the scope of RPS's appointment with its client and is subject to the terms and conditions of that appointment. RPS accepts no liability for any use of this document other than by its client and only for the purposes for which it was prepared and provided.
 2. If received electronically it is the recipients responsibility to print to correct scale. Only written dimensions should be used.
 3. This drawing is to be read in conjunction with all relevant scheme drawings.

Vehicle Profile

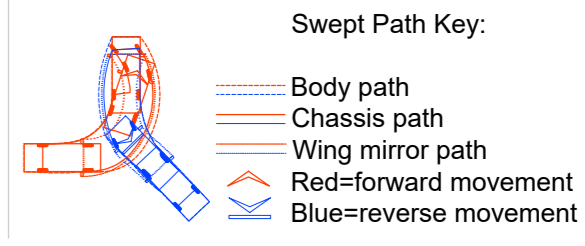
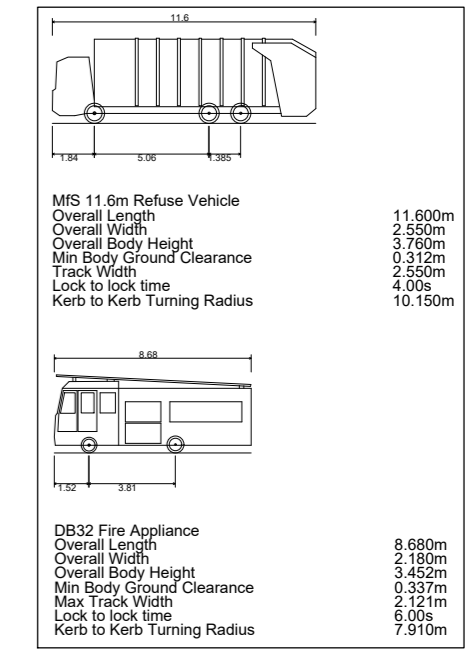

**PRELIMINARY
NOT FOR
CONSTRUCTION**

Rev	Description	By	CB	Date

rps MAKING COMPLEX EASY
20 Farringdon Street, London EC4A 4AB
T: +44(0)20 3691 0500 E: transport@rpsgroup.com

Client Vistry Group

Project Colney Heath

Title Refuse Vehicle & Fire Appliance Swept Path Analysis

Status	Drawn By	PM/Checked by
INFORMATION	AJ	MSB
Project Number	Scale @ A2	Date Created
JNY11289	1:500	26/05/22

RPS Drawing/Figure Number	Rev
JNY11289-RPS-0100-002	-

rpsgroup.com

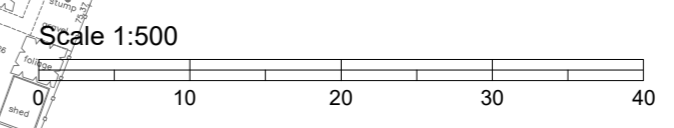

Appendix 12 – TRICS Output

TRIP RATE CALCULATION SELECTION PARAMETERS:

Land Use : 03 - RESIDENTIAL
 Category : A - HOUSES PRIVATELY OWNED
 MULTI-MODAL TOTAL VEHICLES

Selected regions and areas:

02	SOUTH EAST	
	ES EAST SUSSEX	1 days
	HC HAMPSHIRE	1 days
	KC KENT	1 days
	WS WEST SUSSEX	4 days
03	SOUTH WEST	
	DV DEVON	1 days
04	EAST ANGLIA	
	SF SUFFOLK	1 days

This section displays the number of survey days per TRICS® sub-region in the selected set

Primary Filtering selection:

This data displays the chosen trip rate parameter and its selected range. Only sites that fall within the parameter range are included in the trip rate calculation.

Parameter: No of Dwellings
 Actual Range: 116 to 197 (units:)
 Range Selected by User: 100 to 200 (units:)

Parking Spaces Range: All Surveys Included

Parking Spaces per Dwelling Range: All Surveys Included

Bedrooms per Dwelling Range: All Surveys Included

Percentage of dwellings privately owned: All Surveys Included

Public Transport Provision:

Selection by: Include all surveys

Date Range: 01/01/14 to 08/11/21

This data displays the range of survey dates selected. Only surveys that were conducted within this date range are included in the trip rate calculation.

Selected survey days:

Monday	1 days
Tuesday	1 days
Wednesday	2 days
Thursday	3 days
Friday	2 days

This data displays the number of selected surveys by day of the week.

Selected survey types:

Manual count	9 days
Directional ATC Count	0 days

This data displays the number of manual classified surveys and the number of unclassified ATC surveys, the total adding up to the overall number of surveys in the selected set. Manual surveys are undertaken using staff, whilst ATC surveys are undertaken using machines.

Selected Locations:

Suburban Area (PPS6 Out of Centre)	2
Edge of Town	6
Neighbourhood Centre (PPS6 Local Centre)	1

This data displays the number of surveys per main location category within the selected set. The main location categories consist of Free Standing, Edge of Town, Suburban Area, Neighbourhood Centre, Edge of Town Centre, Town Centre and Not Known.

Selected Location Sub Categories:

Residential Zone	8
Village	1

This data displays the number of surveys per location sub-category within the selected set. The location sub-categories consist of Commercial Zone, Industrial Zone, Development Zone, Residential Zone, Retail Zone, Built-Up Zone, Village, Out of Town, High Street and No Sub Category.

Secondary Filtering selection:

Use Class:

C3 9 days

This data displays the number of surveys per Use Class classification within the selected set. The Use Classes Order 2005 has been used for this purpose, which can be found within the Library module of TRICS@.

Population within 500m Range:

All Surveys Included

Population within 1 mile:

1,000 or Less	1 days
1,001 to 5,000	1 days
10,001 to 15,000	3 days
15,001 to 20,000	1 days
20,001 to 25,000	2 days
25,001 to 50,000	1 days

This data displays the number of selected surveys within stated 1-mile radii of population.

Population within 5 miles:

5,001 to 25,000	2 days
25,001 to 50,000	1 days
75,001 to 100,000	2 days
125,001 to 250,000	4 days

This data displays the number of selected surveys within stated 5-mile radii of population.

Car ownership within 5 miles:

1.1 to 1.5 9 days

This data displays the number of selected surveys within stated ranges of average cars owned per residential dwelling, within a radius of 5-miles of selected survey sites.

Travel Plan:

Yes	6 days
No	3 days

This data displays the number of surveys within the selected set that were undertaken at sites with Travel Plans in place, and the number of surveys that were undertaken at sites without Travel Plans.

PTAL Rating:

No PTAL Present 9 days

This data displays the number of selected surveys with PTAL Ratings.

Covid-19 Restrictions	Yes	At least one survey within the selected data set was undertaken at a time of Covid-19 restrictions
-----------------------	-----	--

LIST OF SITES relevant to selection parameters

1	DV-03-A-02 MILLHEAD ROAD HONITON	HOUSES & BUNGALOWS	DEVON
	Suburban Area (PPS6 Out of Centre) Residential Zone Total No of Dwellings: 116 <i>Survey date: FRIDAY 25/09/15</i>		
	<i>Survey Type: MANUAL</i>		
2	ES-03-A-04 NEW LYDD ROAD CAMBER	MIXED HOUSES & FLATS	EAST SUSSEX
	Edge of Town Residential Zone Total No of Dwellings: 134 <i>Survey date: FRIDAY 15/07/16</i>		
	<i>Survey Type: MANUAL</i>		
3	HC-03-A-28 EAGLE AVENUE WATERLOOVILLE LOVEDEAN	MIXED HOUSES & FLATS	HAMPSHIRE
	Edge of Town Residential Zone Total No of Dwellings: 125 <i>Survey date: MONDAY 08/11/21</i>		
	<i>Survey Type: MANUAL</i>		
4	KC-03-A-08 MAIDSTONE ROAD CHARING	MIXED HOUSES	KENT
	Neighbourhood Centre (PPS6 Local Centre) Village Total No of Dwellings: 159 <i>Survey date: TUESDAY 22/05/18</i>		
	<i>Survey Type: MANUAL</i>		
5	SF-03-A-09 FOXHALL ROAD IPSWICH	MIXED HOUSES & FLATS	SUFFOLK
	Suburban Area (PPS6 Out of Centre) Residential Zone Total No of Dwellings: 179 <i>Survey date: THURSDAY 24/06/21</i>		
	<i>Survey Type: MANUAL</i>		
6	WS-03-A-04 HILLS FARM LANE HORSHAM BROADBRIDGE HEATH	MIXED HOUSES	WEST SUSSEX
	Edge of Town Residential Zone Total No of Dwellings: 151 <i>Survey date: THURSDAY 11/12/14</i>		
	<i>Survey Type: MANUAL</i>		
7	WS-03-A-08 ROUNDSTONE LANE ANGMERING	MIXED HOUSES	WEST SUSSEX
	Edge of Town Residential Zone Total No of Dwellings: 180 <i>Survey date: THURSDAY 19/04/18</i>		
	<i>Survey Type: MANUAL</i>		

LIST OF SITES relevant to selection parameters (Cont.)

8	WS-03-A-13	MIXED HOUSES & FLATS	WEST SUSSEX
	LITTLEHAMPTON ROAD		
	WORTHING		
	WEST DURRINGTON		
	Edge of Town		
	Residential Zone		
	Total No of Dwellings:	197	
	Survey date: WEDNESDAY	23/06/21	Survey Type: MANUAL
9	WS-03-A-14	MIXED HOUSES	WEST SUSSEX
	TODDINGTON LANE		
	LITTLEHAMPTON		
	WICK		
	Edge of Town		
	Residential Zone		
	Total No of Dwellings:	117	
	Survey date: WEDNESDAY	20/10/21	Survey Type: MANUAL

This section provides a list of all survey sites and days in the selected set. For each individual survey site, it displays a unique site reference code and site address, the selected trip rate calculation parameter and its value, the day of the week and date of each survey, and whether the survey was a manual classified count or an ATC count.

TRIP RATE for Land Use 03 - RESIDENTIAL/A - HOUSES PRIVATELY OWNED

MULTI-MODAL TOTAL VEHICLES

Calculation factor: 1 DWELLS

BOLD print indicates peak (busiest) period

Total People to Total Vehicles ratio (all time periods and directions): 1.82

Time Range	ARRIVALS			DEPARTURES			TOTALS		
	No. Days	Ave. DWELLS	Trip Rate	No. Days	Ave. DWELLS	Trip Rate	No. Days	Ave. DWELLS	Trip Rate
00:00 - 01:00									
01:00 - 02:00									
02:00 - 03:00									
03:00 - 04:00									
04:00 - 05:00									
05:00 - 06:00									
06:00 - 07:00									
07:00 - 08:00	9	151	0.073	9	151	0.271	9	151	0.344
08:00 - 09:00	9	151	0.133	9	151	0.307	9	151	0.440
09:00 - 10:00	9	151	0.142	9	151	0.149	9	151	0.291
10:00 - 11:00	9	151	0.153	9	151	0.175	9	151	0.328
11:00 - 12:00	9	151	0.139	9	151	0.145	9	151	0.284
12:00 - 13:00	9	151	0.147	9	151	0.145	9	151	0.292
13:00 - 14:00	9	151	0.165	9	151	0.149	9	151	0.314
14:00 - 15:00	9	151	0.148	9	151	0.213	9	151	0.361
15:00 - 16:00	9	151	0.250	9	151	0.158	9	151	0.408
16:00 - 17:00	9	151	0.237	9	151	0.161	9	151	0.398
17:00 - 18:00	9	151	0.296	9	151	0.171	9	151	0.467
18:00 - 19:00	9	151	0.235	9	151	0.161	9	151	0.396
19:00 - 20:00									
20:00 - 21:00									
21:00 - 22:00									
22:00 - 23:00									
23:00 - 24:00									
Total Rates:			2.118			2.205			4.323

This section displays the trip rate results based on the selected set of surveys and the selected count type (shown just above the table). It is split by three main columns, representing arrivals trips, departures trips, and total trips (arrivals plus departures). Within each of these main columns are three sub-columns. These display the number of survey days where count data is included (per time period), the average value of the selected trip rate calculation parameter (per time period), and the trip rate result (per time period). Total trip rates (the sum of the column) are also displayed at the foot of the table.

*To obtain a trip rate, the average (mean) trip rate parameter value (TRP) is first calculated for all selected survey days that have count data available for the stated time period. The average (mean) number of arrivals, departures or totals (whichever applies) is also calculated (COUNT) for all selected survey days that have count data available for the stated time period. Then, the average count is divided by the average trip rate parameter value, and multiplied by the stated calculation factor (shown just above the table and abbreviated here as FACT). So, the method is: COUNT/TRP*FACT. Trip rates are then rounded to 3 decimal places.*

The survey data, graphs and all associated supporting information, contained within the TRICS Database are published by TRICS Consortium Limited ("the Company") and the Company claims copyright and database rights in this published work. The Company authorises those who possess a current TRICS licence to access the TRICS Database and copy the data contained within the TRICS Database for the licence holders' use only. Any resulting copy must retain all copyrights and other proprietary notices, and any disclaimer contained thereon.

The Company accepts no responsibility for loss which may arise from reliance on data contained in the TRICS Database. [No warranty of any kind, express or implied, is made as to the data contained in the TRICS Database.]

Parameter summary

Trip rate parameter range selected:	116 - 197 (units:)
Survey date date range:	01/01/14 - 08/11/21
Number of weekdays (Monday-Friday):	9
Number of Saturdays:	0
Number of Sundays:	0
Surveys automatically removed from selection:	1
Surveys manually removed from selection:	0

This section displays a quick summary of some of the data filtering selections made by the TRICS® user. The trip rate calculation parameter range of all selected surveys is displayed first, followed by the range of minimum and maximum survey dates selected by the user. Then, the total number of selected weekdays and weekend days in the selected set of surveys are show. Finally, the number of survey days that have been manually removed from the selected set outside of the standard filtering procedure are displayed.

TRIP RATE for Land Use 03 - RESIDENTIAL/A - HOUSES PRIVATELY OWNED

MULTI-MODAL TAXIS

Calculation factor: 1 DWELLS

BOLD print indicates peak (busiest) period

Time Range	ARRIVALS			DEPARTURES			TOTALS		
	No. Days	Ave. DWELLS	Trip Rate	No. Days	Ave. DWELLS	Trip Rate	No. Days	Ave. DWELLS	Trip Rate
00:00 - 01:00									
01:00 - 02:00									
02:00 - 03:00									
03:00 - 04:00									
04:00 - 05:00									
05:00 - 06:00									
06:00 - 07:00									
07:00 - 08:00	9	151	0.002	9	151	0.002	9	151	0.004
08:00 - 09:00	9	151	0.004	9	151	0.004	9	151	0.008
09:00 - 10:00	9	151	0.003	9	151	0.003	9	151	0.006
10:00 - 11:00	9	151	0.004	9	151	0.004	9	151	0.008
11:00 - 12:00	9	151	0.002	9	151	0.001	9	151	0.003
12:00 - 13:00	9	151	0.001	9	151	0.001	9	151	0.002
13:00 - 14:00	9	151	0.001	9	151	0.001	9	151	0.002
14:00 - 15:00	9	151	0.001	9	151	0.001	9	151	0.002
15:00 - 16:00	9	151	0.009	9	151	0.008	9	151	0.017
16:00 - 17:00	9	151	0.002	9	151	0.003	9	151	0.005
17:00 - 18:00	9	151	0.001	9	151	0.001	9	151	0.002
18:00 - 19:00	9	151	0.001	9	151	0.000	9	151	0.001
19:00 - 20:00									
20:00 - 21:00									
21:00 - 22:00									
22:00 - 23:00									
23:00 - 24:00									
Total Rates:			0.031			0.029			0.060

This section displays the trip rate results based on the selected set of surveys and the selected count type (shown just above the table). It is split by three main columns, representing arrivals trips, departures trips, and total trips (arrivals plus departures). Within each of these main columns are three sub-columns. These display the number of survey days where count data is included (per time period), the average value of the selected trip rate calculation parameter (per time period), and the trip rate result (per time period). Total trip rates (the sum of the column) are also displayed at the foot of the table.

To obtain a trip rate, the average (mean) trip rate parameter value (TRP) is first calculated for all selected survey days that have count data available for the stated time period. The average (mean) number of arrivals, departures or totals (whichever applies) is also calculated (COUNT) for all selected survey days that have count data available for the stated time period. Then, the average count is divided by the average trip rate parameter value, and multiplied by the stated calculation factor (shown just above the table and abbreviated here as FACT). So, the method is: $COUNT/TRP*FACT$. Trip rates are then rounded to 3 decimal places.

TRIP RATE for Land Use 03 - RESIDENTIAL/A - HOUSES PRIVATELY OWNED

MULTI-MODAL OGVS

Calculation factor: 1 DWELLS

BOLD print indicates peak (busiest) period

Time Range	ARRIVALS			DEPARTURES			TOTALS		
	No. Days	Ave. DWELLS	Trip Rate	No. Days	Ave. DWELLS	Trip Rate	No. Days	Ave. DWELLS	Trip Rate
00:00 - 01:00									
01:00 - 02:00									
02:00 - 03:00									
03:00 - 04:00									
04:00 - 05:00									
05:00 - 06:00									
06:00 - 07:00									
07:00 - 08:00	9	151	0.002	9	151	0.003	9	151	0.005
08:00 - 09:00	9	151	0.003	9	151	0.002	9	151	0.005
09:00 - 10:00	9	151	0.001	9	151	0.001	9	151	0.002
10:00 - 11:00	9	151	0.002	9	151	0.001	9	151	0.003
11:00 - 12:00	9	151	0.001	9	151	0.001	9	151	0.002
12:00 - 13:00	9	151	0.001	9	151	0.002	9	151	0.003
13:00 - 14:00	9	151	0.001	9	151	0.001	9	151	0.002
14:00 - 15:00	9	151	0.001	9	151	0.002	9	151	0.003
15:00 - 16:00	9	151	0.001	9	151	0.001	9	151	0.002
16:00 - 17:00	9	151	0.000	9	151	0.001	9	151	0.001
17:00 - 18:00	9	151	0.001	9	151	0.000	9	151	0.001
18:00 - 19:00	9	151	0.000	9	151	0.000	9	151	0.000
19:00 - 20:00									
20:00 - 21:00									
21:00 - 22:00									
22:00 - 23:00									
23:00 - 24:00									
Total Rates:			0.014			0.015			0.029

This section displays the trip rate results based on the selected set of surveys and the selected count type (shown just above the table). It is split by three main columns, representing arrivals trips, departures trips, and total trips (arrivals plus departures). Within each of these main columns are three sub-columns. These display the number of survey days where count data is included (per time period), the average value of the selected trip rate calculation parameter (per time period), and the trip rate result (per time period). Total trip rates (the sum of the column) are also displayed at the foot of the table.

To obtain a trip rate, the average (mean) trip rate parameter value (TRP) is first calculated for all selected survey days that have count data available for the stated time period. The average (mean) number of arrivals, departures or totals (whichever applies) is also calculated (COUNT) for all selected survey days that have count data available for the stated time period. Then, the average count is divided by the average trip rate parameter value, and multiplied by the stated calculation factor (shown just above the table and abbreviated here as FACT). So, the method is: $COUNT/TRP*FACT$. Trip rates are then rounded to 3 decimal places.

TRIP RATE for Land Use 03 - RESIDENTIAL/A - HOUSES PRIVATELY OWNED

MULTI-MODAL PSVS

Calculation factor: 1 DWELLS

BOLD print indicates peak (busiest) period

Time Range	ARRIVALS			DEPARTURES			TOTALS		
	No. Days	Ave. DWELLS	Trip Rate	No. Days	Ave. DWELLS	Trip Rate	No. Days	Ave. DWELLS	Trip Rate
00:00 - 01:00									
01:00 - 02:00									
02:00 - 03:00									
03:00 - 04:00									
04:00 - 05:00									
05:00 - 06:00									
06:00 - 07:00									
07:00 - 08:00	9	151	0.001	9	151	0.000	9	151	0.001
08:00 - 09:00	9	151	0.000	9	151	0.001	9	151	0.001
09:00 - 10:00	9	151	0.000	9	151	0.000	9	151	0.000
10:00 - 11:00	9	151	0.000	9	151	0.000	9	151	0.000
11:00 - 12:00	9	151	0.000	9	151	0.000	9	151	0.000
12:00 - 13:00	9	151	0.000	9	151	0.000	9	151	0.000
13:00 - 14:00	9	151	0.000	9	151	0.000	9	151	0.000
14:00 - 15:00	9	151	0.000	9	151	0.000	9	151	0.000
15:00 - 16:00	9	151	0.001	9	151	0.001	9	151	0.002
16:00 - 17:00	9	151	0.000	9	151	0.000	9	151	0.000
17:00 - 18:00	9	151	0.000	9	151	0.000	9	151	0.000
18:00 - 19:00	9	151	0.000	9	151	0.000	9	151	0.000
19:00 - 20:00									
20:00 - 21:00									
21:00 - 22:00									
22:00 - 23:00									
23:00 - 24:00									
Total Rates:			0.002			0.002			0.004

This section displays the trip rate results based on the selected set of surveys and the selected count type (shown just above the table). It is split by three main columns, representing arrivals trips, departures trips, and total trips (arrivals plus departures). Within each of these main columns are three sub-columns. These display the number of survey days where count data is included (per time period), the average value of the selected trip rate calculation parameter (per time period), and the trip rate result (per time period). Total trip rates (the sum of the column) are also displayed at the foot of the table.

To obtain a trip rate, the average (mean) trip rate parameter value (TRP) is first calculated for all selected survey days that have count data available for the stated time period. The average (mean) number of arrivals, departures or totals (whichever applies) is also calculated (COUNT) for all selected survey days that have count data available for the stated time period. Then, the average count is divided by the average trip rate parameter value, and multiplied by the stated calculation factor (shown just above the table and abbreviated here as FACT). So, the method is: $COUNT/TRP*FACT$. Trip rates are then rounded to 3 decimal places.

TRIP RATE for Land Use 03 - RESIDENTIAL/A - HOUSES PRIVATELY OWNED

MULTI-MODAL CYCLISTS

Calculation factor: 1 DWELLS

BOLD print indicates peak (busiest) period

Time Range	ARRIVALS			DEPARTURES			TOTALS		
	No. Days	Ave. DWELLS	Trip Rate	No. Days	Ave. DWELLS	Trip Rate	No. Days	Ave. DWELLS	Trip Rate
00:00 - 01:00									
01:00 - 02:00									
02:00 - 03:00									
03:00 - 04:00									
04:00 - 05:00									
05:00 - 06:00									
06:00 - 07:00									
07:00 - 08:00	9	151	0.004	9	151	0.013	9	151	0.017
08:00 - 09:00	9	151	0.006	9	151	0.021	9	151	0.027
09:00 - 10:00	9	151	0.001	9	151	0.001	9	151	0.002
10:00 - 11:00	9	151	0.004	9	151	0.006	9	151	0.010
11:00 - 12:00	9	151	0.005	9	151	0.001	9	151	0.006
12:00 - 13:00	9	151	0.003	9	151	0.007	9	151	0.010
13:00 - 14:00	9	151	0.002	9	151	0.006	9	151	0.008
14:00 - 15:00	9	151	0.005	9	151	0.007	9	151	0.012
15:00 - 16:00	9	151	0.024	9	151	0.013	9	151	0.037
16:00 - 17:00	9	151	0.025	9	151	0.018	9	151	0.043
17:00 - 18:00	9	151	0.016	9	151	0.010	9	151	0.026
18:00 - 19:00	9	151	0.013	9	151	0.007	9	151	0.020
19:00 - 20:00									
20:00 - 21:00									
21:00 - 22:00									
22:00 - 23:00									
23:00 - 24:00									
Total Rates:			0.108			0.110			0.218

This section displays the trip rate results based on the selected set of surveys and the selected count type (shown just above the table). It is split by three main columns, representing arrivals trips, departures trips, and total trips (arrivals plus departures). Within each of these main columns are three sub-columns. These display the number of survey days where count data is included (per time period), the average value of the selected trip rate calculation parameter (per time period), and the trip rate result (per time period). Total trip rates (the sum of the column) are also displayed at the foot of the table.

To obtain a trip rate, the average (mean) trip rate parameter value (TRP) is first calculated for all selected survey days that have count data available for the stated time period. The average (mean) number of arrivals, departures or totals (whichever applies) is also calculated (COUNT) for all selected survey days that have count data available for the stated time period. Then, the average count is divided by the average trip rate parameter value, and multiplied by the stated calculation factor (shown just above the table and abbreviated here as FACT). So, the method is: $COUNT/TRP*FACT$. Trip rates are then rounded to 3 decimal places.

TRIP RATE for Land Use 03 - RESIDENTIAL/A - HOUSES PRIVATELY OWNED
 MULTI-MODAL VEHICLE OCCUPANTS
 Calculation factor: 1 DWELLS
 BOLD print indicates peak (busiest) period

Time Range	ARRIVALS			DEPARTURES			TOTALS		
	No. Days	Ave. DWELLS	Trip Rate	No. Days	Ave. DWELLS	Trip Rate	No. Days	Ave. DWELLS	Trip Rate
00:00 - 01:00									
01:00 - 02:00									
02:00 - 03:00									
03:00 - 04:00									
04:00 - 05:00									
05:00 - 06:00									
06:00 - 07:00									
07:00 - 08:00	9	151	0.082	9	151	0.378	9	151	0.460
08:00 - 09:00	9	151	0.148	9	151	0.529	9	151	0.677
09:00 - 10:00	9	151	0.166	9	151	0.203	9	151	0.369
10:00 - 11:00	9	151	0.191	9	151	0.240	9	151	0.431
11:00 - 12:00	9	151	0.177	9	151	0.207	9	151	0.384
12:00 - 13:00	9	151	0.189	9	151	0.194	9	151	0.383
13:00 - 14:00	9	151	0.241	9	151	0.203	9	151	0.444
14:00 - 15:00	9	151	0.193	9	151	0.295	9	151	0.488
15:00 - 16:00	9	151	0.427	9	151	0.214	9	151	0.641
16:00 - 17:00	9	151	0.383	9	151	0.227	9	151	0.610
17:00 - 18:00	9	151	0.415	9	151	0.240	9	151	0.655
18:00 - 19:00	9	151	0.353	9	151	0.225	9	151	0.578
19:00 - 20:00									
20:00 - 21:00									
21:00 - 22:00									
22:00 - 23:00									
23:00 - 24:00									
Total Rates:			2.965			3.155			6.120

This section displays the trip rate results based on the selected set of surveys and the selected count type (shown just above the table). It is split by three main columns, representing arrivals trips, departures trips, and total trips (arrivals plus departures). Within each of these main columns are three sub-columns. These display the number of survey days where count data is included (per time period), the average value of the selected trip rate calculation parameter (per time period), and the trip rate result (per time period). Total trip rates (the sum of the column) are also displayed at the foot of the table.

*To obtain a trip rate, the average (mean) trip rate parameter value (TRP) is first calculated for all selected survey days that have count data available for the stated time period. The average (mean) number of arrivals, departures or totals (whichever applies) is also calculated (COUNT) for all selected survey days that have count data available for the stated time period. Then, the average count is divided by the average trip rate parameter value, and multiplied by the stated calculation factor (shown just above the table and abbreviated here as FACT). So, the method is: COUNT/TRP*FACT. Trip rates are then rounded to 3 decimal places.*

TRIP RATE for Land Use 03 - RESIDENTIAL/A - HOUSES PRIVATELY OWNED

MULTI-MODAL PEDESTRIANS

Calculation factor: 1 DWELLS

BOLD print indicates peak (busiest) period

Time Range	ARRIVALS			DEPARTURES			TOTALS		
	No. Days	Ave. DWELLS	Trip Rate	No. Days	Ave. DWELLS	Trip Rate	No. Days	Ave. DWELLS	Trip Rate
00:00 - 01:00									
01:00 - 02:00									
02:00 - 03:00									
03:00 - 04:00									
04:00 - 05:00									
05:00 - 06:00									
06:00 - 07:00									
07:00 - 08:00	9	151	0.022	9	151	0.039	9	151	0.061
08:00 - 09:00	9	151	0.046	9	151	0.134	9	151	0.180
09:00 - 10:00	9	151	0.047	9	151	0.053	9	151	0.100
10:00 - 11:00	9	151	0.054	9	151	0.059	9	151	0.113
11:00 - 12:00	9	151	0.045	9	151	0.049	9	151	0.094
12:00 - 13:00	9	151	0.045	9	151	0.045	9	151	0.090
13:00 - 14:00	9	151	0.046	9	151	0.038	9	151	0.084
14:00 - 15:00	9	151	0.040	9	151	0.055	9	151	0.095
15:00 - 16:00	9	151	0.135	9	151	0.061	9	151	0.196
16:00 - 17:00	9	151	0.100	9	151	0.060	9	151	0.160
17:00 - 18:00	9	151	0.075	9	151	0.029	9	151	0.104
18:00 - 19:00	9	151	0.052	9	151	0.050	9	151	0.102
19:00 - 20:00									
20:00 - 21:00									
21:00 - 22:00									
22:00 - 23:00									
23:00 - 24:00									
Total Rates:			0.707			0.672			1.379

This section displays the trip rate results based on the selected set of surveys and the selected count type (shown just above the table). It is split by three main columns, representing arrivals trips, departures trips, and total trips (arrivals plus departures). Within each of these main columns are three sub-columns. These display the number of survey days where count data is included (per time period), the average value of the selected trip rate calculation parameter (per time period), and the trip rate result (per time period). Total trip rates (the sum of the column) are also displayed at the foot of the table.

To obtain a trip rate, the average (mean) trip rate parameter value (TRP) is first calculated for all selected survey days that have count data available for the stated time period. The average (mean) number of arrivals, departures or totals (whichever applies) is also calculated (COUNT) for all selected survey days that have count data available for the stated time period. Then, the average count is divided by the average trip rate parameter value, and multiplied by the stated calculation factor (shown just above the table and abbreviated here as FACT). So, the method is: $COUNT/TRP*FACT$. Trip rates are then rounded to 3 decimal places.

TRIP RATE for Land Use 03 - RESIDENTIAL/A - HOUSES PRIVATELY OWNED

MULTI-MODAL BUS/TRAM PASSENGERS

Calculation factor: 1 DWELLS

BOLD print indicates peak (busiest) period

Time Range	ARRIVALS			DEPARTURES			TOTALS		
	No. Days	Ave. DWELLS	Trip Rate	No. Days	Ave. DWELLS	Trip Rate	No. Days	Ave. DWELLS	Trip Rate
00:00 - 01:00									
01:00 - 02:00									
02:00 - 03:00									
03:00 - 04:00									
04:00 - 05:00									
05:00 - 06:00									
06:00 - 07:00									
07:00 - 08:00	9	151	0.000	9	151	0.013	9	151	0.013
08:00 - 09:00	9	151	0.000	9	151	0.015	9	151	0.015
09:00 - 10:00	9	151	0.001	9	151	0.009	9	151	0.010
10:00 - 11:00	9	151	0.004	9	151	0.002	9	151	0.006
11:00 - 12:00	9	151	0.003	9	151	0.005	9	151	0.008
12:00 - 13:00	9	151	0.004	9	151	0.005	9	151	0.009
13:00 - 14:00	9	151	0.002	9	151	0.004	9	151	0.006
14:00 - 15:00	9	151	0.006	9	151	0.005	9	151	0.011
15:00 - 16:00	9	151	0.007	9	151	0.003	9	151	0.010
16:00 - 17:00	9	151	0.011	9	151	0.006	9	151	0.017
17:00 - 18:00	9	151	0.013	9	151	0.001	9	151	0.014
18:00 - 19:00	9	151	0.004	9	151	0.000	9	151	0.004
19:00 - 20:00									
20:00 - 21:00									
21:00 - 22:00									
22:00 - 23:00									
23:00 - 24:00									
Total Rates:			0.055			0.068			0.123

This section displays the trip rate results based on the selected set of surveys and the selected count type (shown just above the table). It is split by three main columns, representing arrivals trips, departures trips, and total trips (arrivals plus departures). Within each of these main columns are three sub-columns. These display the number of survey days where count data is included (per time period), the average value of the selected trip rate calculation parameter (per time period), and the trip rate result (per time period). Total trip rates (the sum of the column) are also displayed at the foot of the table.

To obtain a trip rate, the average (mean) trip rate parameter value (TRP) is first calculated for all selected survey days that have count data available for the stated time period. The average (mean) number of arrivals, departures or totals (whichever applies) is also calculated (COUNT) for all selected survey days that have count data available for the stated time period. Then, the average count is divided by the average trip rate parameter value, and multiplied by the stated calculation factor (shown just above the table and abbreviated here as FACT). So, the method is: $COUNT/TRP*FACT$. Trip rates are then rounded to 3 decimal places.

TRIP RATE for Land Use 03 - RESIDENTIAL/A - HOUSES PRIVATELY OWNED

MULTI-MODAL TOTAL RAIL PASSENGERS

Calculation factor: 1 DWELLS

BOLD print indicates peak (busiest) period

Time Range	ARRIVALS			DEPARTURES			TOTALS		
	No. Days	Ave. DWELLS	Trip Rate	No. Days	Ave. DWELLS	Trip Rate	No. Days	Ave. DWELLS	Trip Rate
00:00 - 01:00									
01:00 - 02:00									
02:00 - 03:00									
03:00 - 04:00									
04:00 - 05:00									
05:00 - 06:00									
06:00 - 07:00									
07:00 - 08:00	9	151	0.004	9	151	0.003	9	151	0.007
08:00 - 09:00	9	151	0.000	9	151	0.001	9	151	0.001
09:00 - 10:00	9	151	0.000	9	151	0.000	9	151	0.000
10:00 - 11:00	9	151	0.000	9	151	0.000	9	151	0.000
11:00 - 12:00	9	151	0.000	9	151	0.000	9	151	0.000
12:00 - 13:00	9	151	0.000	9	151	0.003	9	151	0.003
13:00 - 14:00	9	151	0.000	9	151	0.001	9	151	0.001
14:00 - 15:00	9	151	0.000	9	151	0.000	9	151	0.000
15:00 - 16:00	9	151	0.001	9	151	0.000	9	151	0.001
16:00 - 17:00	9	151	0.000	9	151	0.000	9	151	0.000
17:00 - 18:00	9	151	0.000	9	151	0.000	9	151	0.000
18:00 - 19:00	9	151	0.001	9	151	0.000	9	151	0.001
19:00 - 20:00									
20:00 - 21:00									
21:00 - 22:00									
22:00 - 23:00									
23:00 - 24:00									
Total Rates:			0.006			0.008			0.014

This section displays the trip rate results based on the selected set of surveys and the selected count type (shown just above the table). It is split by three main columns, representing arrivals trips, departures trips, and total trips (arrivals plus departures). Within each of these main columns are three sub-columns. These display the number of survey days where count data is included (per time period), the average value of the selected trip rate calculation parameter (per time period), and the trip rate result (per time period). Total trip rates (the sum of the column) are also displayed at the foot of the table.

To obtain a trip rate, the average (mean) trip rate parameter value (TRP) is first calculated for all selected survey days that have count data available for the stated time period. The average (mean) number of arrivals, departures or totals (whichever applies) is also calculated (COUNT) for all selected survey days that have count data available for the stated time period. Then, the average count is divided by the average trip rate parameter value, and multiplied by the stated calculation factor (shown just above the table and abbreviated here as FACT). So, the method is: $COUNT/TRP*FACT$. Trip rates are then rounded to 3 decimal places.

TRIP RATE for Land Use 03 - RESIDENTIAL/A - HOUSES PRIVATELY OWNED

MULTI-MODAL COACH PASSENGERS

Calculation factor: 1 DWELLS

BOLD print indicates peak (busiest) period

Time Range	ARRIVALS			DEPARTURES			TOTALS		
	No. Days	Ave. DWELLS	Trip Rate	No. Days	Ave. DWELLS	Trip Rate	No. Days	Ave. DWELLS	Trip Rate
00:00 - 01:00									
01:00 - 02:00									
02:00 - 03:00									
03:00 - 04:00									
04:00 - 05:00									
05:00 - 06:00									
06:00 - 07:00									
07:00 - 08:00	9	151	0.000	9	151	0.000	9	151	0.000
08:00 - 09:00	9	151	0.000	9	151	0.000	9	151	0.000
09:00 - 10:00	9	151	0.000	9	151	0.000	9	151	0.000
10:00 - 11:00	9	151	0.000	9	151	0.000	9	151	0.000
11:00 - 12:00	9	151	0.000	9	151	0.000	9	151	0.000
12:00 - 13:00	9	151	0.000	9	151	0.000	9	151	0.000
13:00 - 14:00	9	151	0.000	9	151	0.000	9	151	0.000
14:00 - 15:00	9	151	0.000	9	151	0.000	9	151	0.000
15:00 - 16:00	9	151	0.001	9	151	0.001	9	151	0.002
16:00 - 17:00	9	151	0.000	9	151	0.000	9	151	0.000
17:00 - 18:00	9	151	0.000	9	151	0.000	9	151	0.000
18:00 - 19:00	9	151	0.000	9	151	0.000	9	151	0.000
19:00 - 20:00									
20:00 - 21:00									
21:00 - 22:00									
22:00 - 23:00									
23:00 - 24:00									
Total Rates:			0.001			0.001			0.002

This section displays the trip rate results based on the selected set of surveys and the selected count type (shown just above the table). It is split by three main columns, representing arrivals trips, departures trips, and total trips (arrivals plus departures). Within each of these main columns are three sub-columns. These display the number of survey days where count data is included (per time period), the average value of the selected trip rate calculation parameter (per time period), and the trip rate result (per time period). Total trip rates (the sum of the column) are also displayed at the foot of the table.

To obtain a trip rate, the average (mean) trip rate parameter value (TRP) is first calculated for all selected survey days that have count data available for the stated time period. The average (mean) number of arrivals, departures or totals (whichever applies) is also calculated (COUNT) for all selected survey days that have count data available for the stated time period. Then, the average count is divided by the average trip rate parameter value, and multiplied by the stated calculation factor (shown just above the table and abbreviated here as FACT). So, the method is: $COUNT/TRP*FACT$. Trip rates are then rounded to 3 decimal places.

TRIP RATE for Land Use 03 - RESIDENTIAL/A - HOUSES PRIVATELY OWNED

MULTI-MODAL PUBLIC TRANSPORT USERS

Calculation factor: 1 DWELLS

BOLD print indicates peak (busiest) period

Time Range	ARRIVALS			DEPARTURES			TOTALS		
	No. Days	Ave. DWELLS	Trip Rate	No. Days	Ave. DWELLS	Trip Rate	No. Days	Ave. DWELLS	Trip Rate
00:00 - 01:00									
01:00 - 02:00									
02:00 - 03:00									
03:00 - 04:00									
04:00 - 05:00									
05:00 - 06:00									
06:00 - 07:00									
07:00 - 08:00	9	151	0.004	9	151	0.015	9	151	0.019
08:00 - 09:00	9	151	0.000	9	151	0.016	9	151	0.016
09:00 - 10:00	9	151	0.001	9	151	0.009	9	151	0.010
10:00 - 11:00	9	151	0.004	9	151	0.002	9	151	0.006
11:00 - 12:00	9	151	0.003	9	151	0.005	9	151	0.008
12:00 - 13:00	9	151	0.004	9	151	0.008	9	151	0.012
13:00 - 14:00	9	151	0.002	9	151	0.005	9	151	0.007
14:00 - 15:00	9	151	0.006	9	151	0.005	9	151	0.011
15:00 - 16:00	9	151	0.009	9	151	0.004	9	151	0.013
16:00 - 17:00	9	151	0.011	9	151	0.006	9	151	0.017
17:00 - 18:00	9	151	0.013	9	151	0.001	9	151	0.014
18:00 - 19:00	9	151	0.004	9	151	0.000	9	151	0.004
19:00 - 20:00									
20:00 - 21:00									
21:00 - 22:00									
22:00 - 23:00									
23:00 - 24:00									
Total Rates:			0.061			0.076			0.137

This section displays the trip rate results based on the selected set of surveys and the selected count type (shown just above the table). It is split by three main columns, representing arrivals trips, departures trips, and total trips (arrivals plus departures). Within each of these main columns are three sub-columns. These display the number of survey days where count data is included (per time period), the average value of the selected trip rate calculation parameter (per time period), and the trip rate result (per time period). Total trip rates (the sum of the column) are also displayed at the foot of the table.

To obtain a trip rate, the average (mean) trip rate parameter value (TRP) is first calculated for all selected survey days that have count data available for the stated time period. The average (mean) number of arrivals, departures or totals (whichever applies) is also calculated (COUNT) for all selected survey days that have count data available for the stated time period. Then, the average count is divided by the average trip rate parameter value, and multiplied by the stated calculation factor (shown just above the table and abbreviated here as FACT). So, the method is: $COUNT/TRP*FACT$. Trip rates are then rounded to 3 decimal places.

TRIP RATE for Land Use 03 - RESIDENTIAL/A - HOUSES PRIVATELY OWNED

MULTI-MODAL TOTAL PEOPLE

Calculation factor: 1 DWELLS

BOLD print indicates peak (busiest) period

Total People to Total Vehicles ratio (all time periods and directions): 1.82

Time Range	ARRIVALS			DEPARTURES			TOTALS		
	No. Days	Ave. DWELLS	Trip Rate	No. Days	Ave. DWELLS	Trip Rate	No. Days	Ave. DWELLS	Trip Rate
00:00 - 01:00									
01:00 - 02:00									
02:00 - 03:00									
03:00 - 04:00									
04:00 - 05:00									
05:00 - 06:00									
06:00 - 07:00									
07:00 - 08:00	9	151	0.111	9	151	0.445	9	151	0.556
08:00 - 09:00	9	151	0.200	9	151	0.700	9	151	0.900
09:00 - 10:00	9	151	0.215	9	151	0.267	9	151	0.482
10:00 - 11:00	9	151	0.253	9	151	0.307	9	151	0.560
11:00 - 12:00	9	151	0.230	9	151	0.262	9	151	0.492
12:00 - 13:00	9	151	0.242	9	151	0.254	9	151	0.496
13:00 - 14:00	9	151	0.291	9	151	0.252	9	151	0.543
14:00 - 15:00	9	151	0.244	9	151	0.363	9	151	0.607
15:00 - 16:00	9	151	0.595	9	151	0.292	9	151	0.887
16:00 - 17:00	9	151	0.519	9	151	0.311	9	151	0.830
17:00 - 18:00	9	151	0.519	9	151	0.279	9	151	0.798
18:00 - 19:00	9	151	0.421	9	151	0.282	9	151	0.703
19:00 - 20:00									
20:00 - 21:00									
21:00 - 22:00									
22:00 - 23:00									
23:00 - 24:00									
Total Rates:			3.840			4.014			7.854

This section displays the trip rate results based on the selected set of surveys and the selected count type (shown just above the table). It is split by three main columns, representing arrivals trips, departures trips, and total trips (arrivals plus departures). Within each of these main columns are three sub-columns. These display the number of survey days where count data is included (per time period), the average value of the selected trip rate calculation parameter (per time period), and the trip rate result (per time period). Total trip rates (the sum of the column) are also displayed at the foot of the table.

To obtain a trip rate, the average (mean) trip rate parameter value (TRP) is first calculated for all selected survey days that have count data available for the stated time period. The average (mean) number of arrivals, departures or totals (whichever applies) is also calculated (COUNT) for all selected survey days that have count data available for the stated time period. Then, the average count is divided by the average trip rate parameter value, and multiplied by the stated calculation factor (shown just above the table and abbreviated here as FACT). So, the method is: $COUNT/TRP*FACT$. Trip rates are then rounded to 3 decimal places.

TRIP RATE for Land Use 03 - RESIDENTIAL/A - HOUSES PRIVATELY OWNED

MULTI-MODAL CARS

Calculation factor: 1 DWELLS

BOLD print indicates peak (busiest) period

Time Range	ARRIVALS			DEPARTURES			TOTALS		
	No. Days	Ave. DWELLS	Trip Rate	No. Days	Ave. DWELLS	Trip Rate	No. Days	Ave. DWELLS	Trip Rate
00:00 - 01:00									
01:00 - 02:00									
02:00 - 03:00									
03:00 - 04:00									
04:00 - 05:00									
05:00 - 06:00									
06:00 - 07:00									
07:00 - 08:00	9	151	0.051	9	151	0.226	9	151	0.277
08:00 - 09:00	9	151	0.109	9	151	0.276	9	151	0.385
09:00 - 10:00	9	151	0.119	9	151	0.133	9	151	0.252
10:00 - 11:00	9	151	0.113	9	151	0.138	9	151	0.251
11:00 - 12:00	9	151	0.112	9	151	0.111	9	151	0.223
12:00 - 13:00	9	151	0.118	9	151	0.119	9	151	0.237
13:00 - 14:00	9	151	0.129	9	151	0.116	9	151	0.245
14:00 - 15:00	9	151	0.130	9	151	0.184	9	151	0.314
15:00 - 16:00	9	151	0.214	9	151	0.127	9	151	0.341
16:00 - 17:00	9	151	0.214	9	151	0.132	9	151	0.346
17:00 - 18:00	9	151	0.253	9	151	0.148	9	151	0.401
18:00 - 19:00	9	151	0.210	9	151	0.147	9	151	0.357
19:00 - 20:00									
20:00 - 21:00									
21:00 - 22:00									
22:00 - 23:00									
23:00 - 24:00									
Total Rates:			1.772			1.857			3.629

This section displays the trip rate results based on the selected set of surveys and the selected count type (shown just above the table). It is split by three main columns, representing arrivals trips, departures trips, and total trips (arrivals plus departures). Within each of these main columns are three sub-columns. These display the number of survey days where count data is included (per time period), the average value of the selected trip rate calculation parameter (per time period), and the trip rate result (per time period). Total trip rates (the sum of the column) are also displayed at the foot of the table.

To obtain a trip rate, the average (mean) trip rate parameter value (TRP) is first calculated for all selected survey days that have count data available for the stated time period. The average (mean) number of arrivals, departures or totals (whichever applies) is also calculated (COUNT) for all selected survey days that have count data available for the stated time period. Then, the average count is divided by the average trip rate parameter value, and multiplied by the stated calculation factor (shown just above the table and abbreviated here as FACT). So, the method is: $COUNT/TRP*FACT$. Trip rates are then rounded to 3 decimal places.

TRIP RATE for Land Use 03 - RESIDENTIAL/A - HOUSES PRIVATELY OWNED

MULTI-MODAL LGVS

Calculation factor: 1 DWELLS

BOLD print indicates peak (busiest) period

Time Range	ARRIVALS			DEPARTURES			TOTALS		
	No. Days	Ave. DWELLS	Trip Rate	No. Days	Ave. DWELLS	Trip Rate	No. Days	Ave. DWELLS	Trip Rate
00:00 - 01:00									
01:00 - 02:00									
02:00 - 03:00									
03:00 - 04:00									
04:00 - 05:00									
05:00 - 06:00									
06:00 - 07:00									
07:00 - 08:00	9	151	0.017	9	151	0.038	9	151	0.055
08:00 - 09:00	9	151	0.017	9	151	0.022	9	151	0.039
09:00 - 10:00	9	151	0.019	9	151	0.012	9	151	0.031
10:00 - 11:00	9	151	0.032	9	151	0.030	9	151	0.062
11:00 - 12:00	9	151	0.023	9	151	0.029	9	151	0.052
12:00 - 13:00	9	151	0.026	9	151	0.021	9	151	0.047
13:00 - 14:00	9	151	0.034	9	151	0.031	9	151	0.065
14:00 - 15:00	9	151	0.015	9	151	0.026	9	151	0.041
15:00 - 16:00	9	151	0.023	9	151	0.021	9	151	0.044
16:00 - 17:00	9	151	0.018	9	151	0.024	9	151	0.042
17:00 - 18:00	9	151	0.041	9	151	0.020	9	151	0.061
18:00 - 19:00	9	151	0.023	9	151	0.013	9	151	0.036
19:00 - 20:00									
20:00 - 21:00									
21:00 - 22:00									
22:00 - 23:00									
23:00 - 24:00									
Total Rates:			0.288			0.287			0.575

This section displays the trip rate results based on the selected set of surveys and the selected count type (shown just above the table). It is split by three main columns, representing arrivals trips, departures trips, and total trips (arrivals plus departures). Within each of these main columns are three sub-columns. These display the number of survey days where count data is included (per time period), the average value of the selected trip rate calculation parameter (per time period), and the trip rate result (per time period). Total trip rates (the sum of the column) are also displayed at the foot of the table.

To obtain a trip rate, the average (mean) trip rate parameter value (TRP) is first calculated for all selected survey days that have count data available for the stated time period. The average (mean) number of arrivals, departures or totals (whichever applies) is also calculated (COUNT) for all selected survey days that have count data available for the stated time period. Then, the average count is divided by the average trip rate parameter value, and multiplied by the stated calculation factor (shown just above the table and abbreviated here as FACT). So, the method is: $COUNT/TRP*FACT$. Trip rates are then rounded to 3 decimal places.

TRIP RATE for Land Use 03 - RESIDENTIAL/A - HOUSES PRIVATELY OWNED

MULTI-MODAL MOTOR CYCLES

Calculation factor: 1 DWELLS

BOLD print indicates peak (busiest) period

Time Range	ARRIVALS			DEPARTURES			TOTALS		
	No. Days	Ave. DWELLS	Trip Rate	No. Days	Ave. DWELLS	Trip Rate	No. Days	Ave. DWELLS	Trip Rate
00:00 - 01:00									
01:00 - 02:00									
02:00 - 03:00									
03:00 - 04:00									
04:00 - 05:00									
05:00 - 06:00									
06:00 - 07:00									
07:00 - 08:00	9	151	0.000	9	151	0.001	9	151	0.001
08:00 - 09:00	9	151	0.000	9	151	0.001	9	151	0.001
09:00 - 10:00	9	151	0.000	9	151	0.000	9	151	0.000
10:00 - 11:00	9	151	0.001	9	151	0.001	9	151	0.002
11:00 - 12:00	9	151	0.001	9	151	0.001	9	151	0.002
12:00 - 13:00	9	151	0.001	9	151	0.001	9	151	0.002
13:00 - 14:00	9	151	0.001	9	151	0.001	9	151	0.002
14:00 - 15:00	9	151	0.001	9	151	0.000	9	151	0.001
15:00 - 16:00	9	151	0.001	9	151	0.001	9	151	0.002
16:00 - 17:00	9	151	0.002	9	151	0.001	9	151	0.003
17:00 - 18:00	9	151	0.001	9	151	0.002	9	151	0.003
18:00 - 19:00	9	151	0.001	9	151	0.001	9	151	0.002
19:00 - 20:00									
20:00 - 21:00									
21:00 - 22:00									
22:00 - 23:00									
23:00 - 24:00									
Total Rates:			0.010			0.011			0.021

This section displays the trip rate results based on the selected set of surveys and the selected count type (shown just above the table). It is split by three main columns, representing arrivals trips, departures trips, and total trips (arrivals plus departures). Within each of these main columns are three sub-columns. These display the number of survey days where count data is included (per time period), the average value of the selected trip rate calculation parameter (per time period), and the trip rate result (per time period). Total trip rates (the sum of the column) are also displayed at the foot of the table.

To obtain a trip rate, the average (mean) trip rate parameter value (TRP) is first calculated for all selected survey days that have count data available for the stated time period. The average (mean) number of arrivals, departures or totals (whichever applies) is also calculated (COUNT) for all selected survey days that have count data available for the stated time period. Then, the average count is divided by the average trip rate parameter value, and multiplied by the stated calculation factor (shown just above the table and abbreviated here as FACT). So, the method is: $COUNT/TRP*FACT$. Trip rates are then rounded to 3 decimal places.

Appendix 13 – Traffic Flow Diagrams

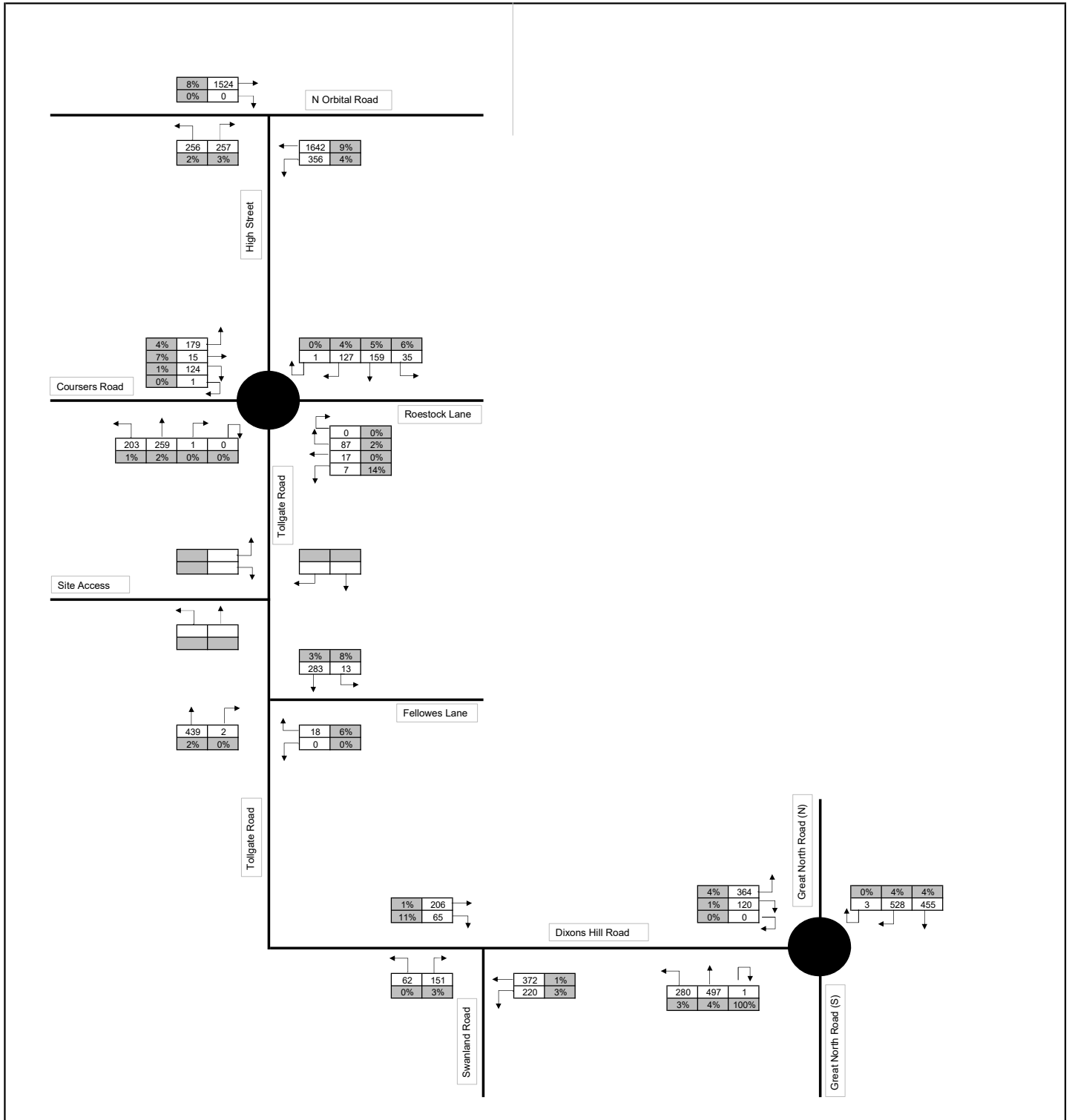

Notes

Project Name: Colney Heath
 Job Number: JNY11289
 Title
 2022 Baseline AM Peak Flows (08:00-09:00)

Total Vehicles
 HGVs (%)

Figure No. 1

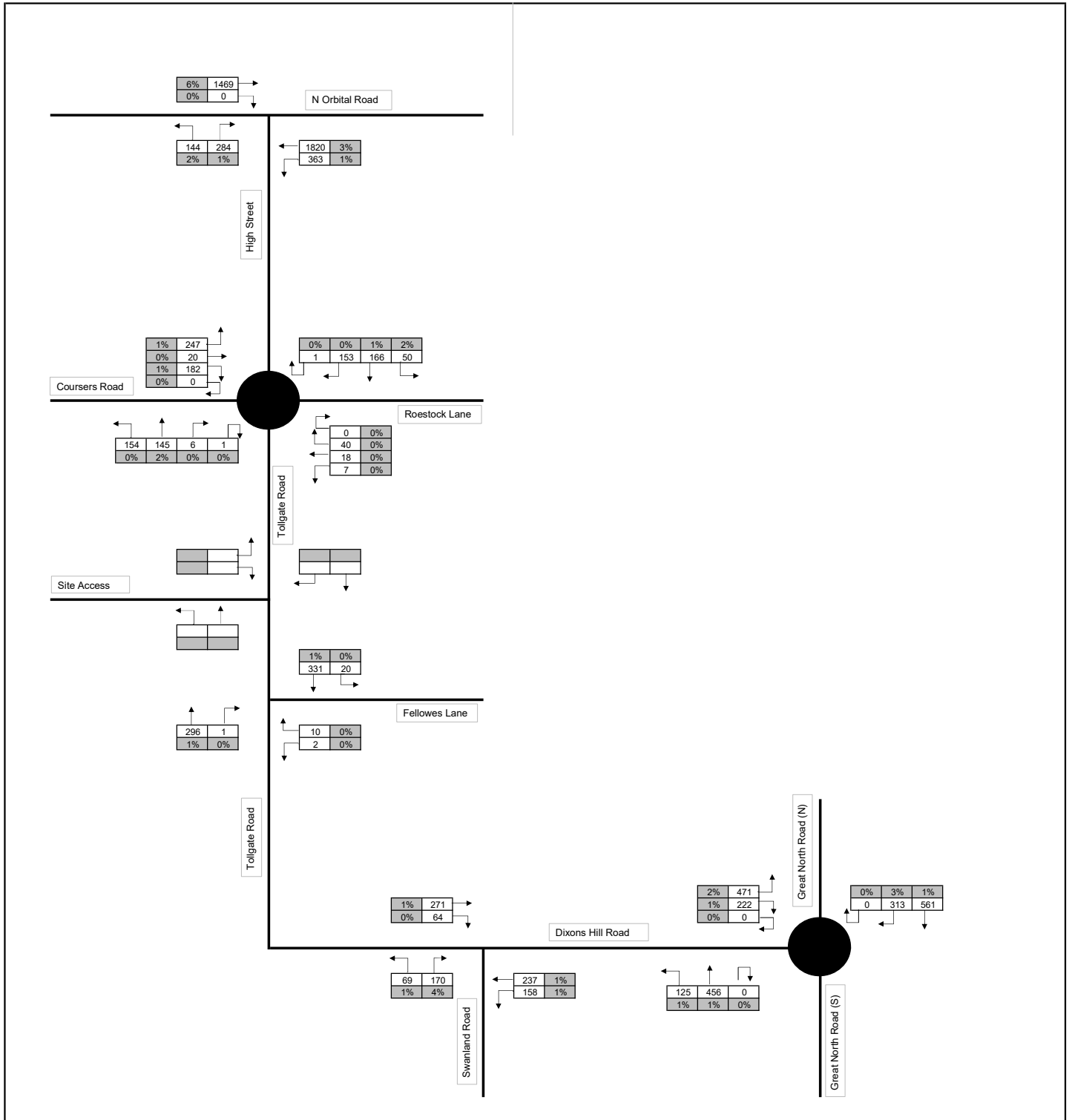

Notes

Project Name: Colney Heath
 Job Number: JNY11289
 Title
 2022 Baseline PM Peak Flows (17:00-18:00)

Total Vehicles
 HGVs (%)

Figure No. 2

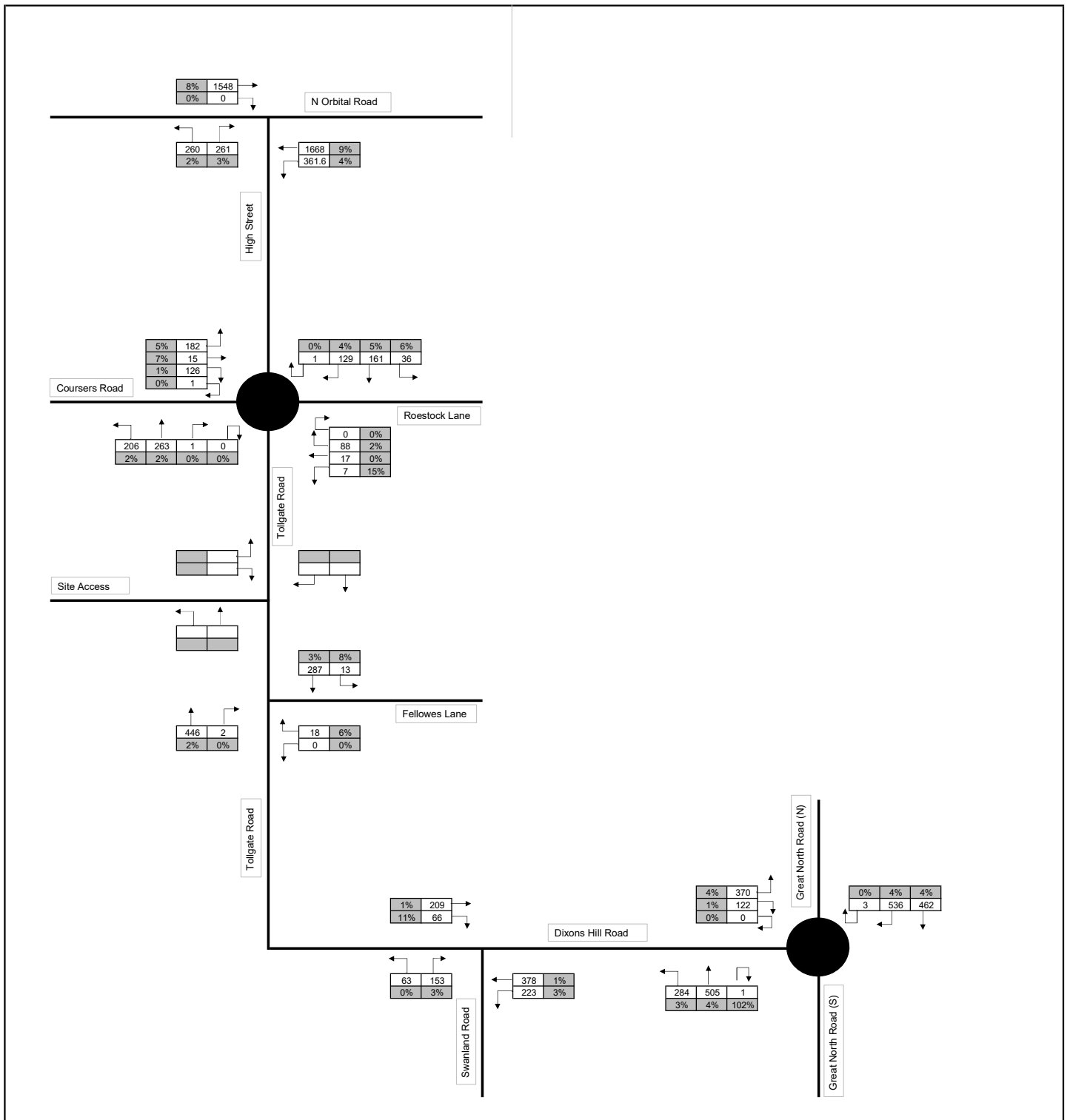

Notes

Project Name: Colney Heath
 Job Number: JNY11289
 Title
 2027 Baseline AM Peak Flows (08:00-09:00)

Total Vehicles
 HGVs (%)

Figure No. 3

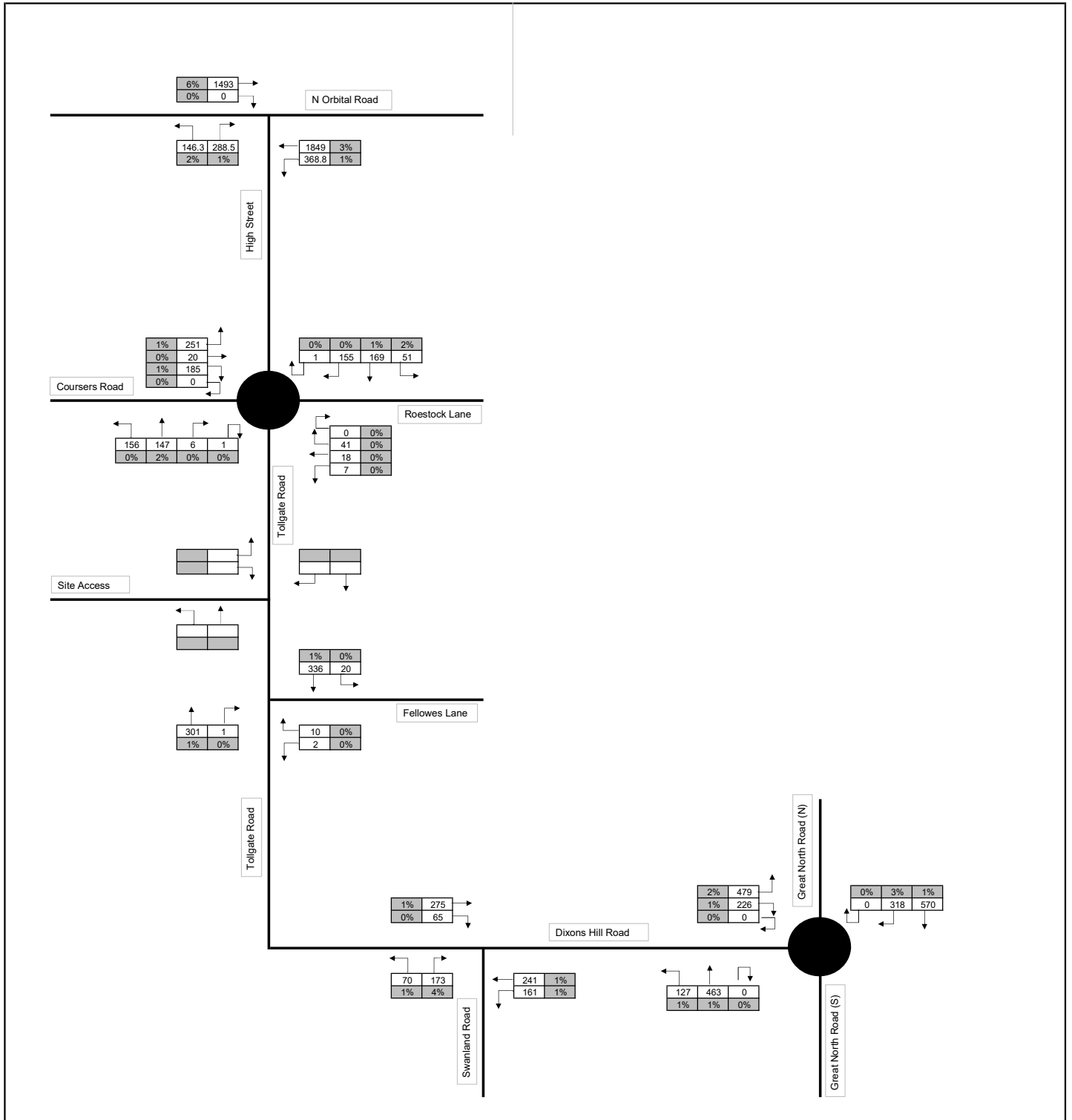

Notes

Project Name: Colney Heath
 Job Number: JNY11289
 Title
 2027 Baseline PM Peak Flows (17:00-18:00)

Total Vehicles
 HGVs (%)

Figure No. 4

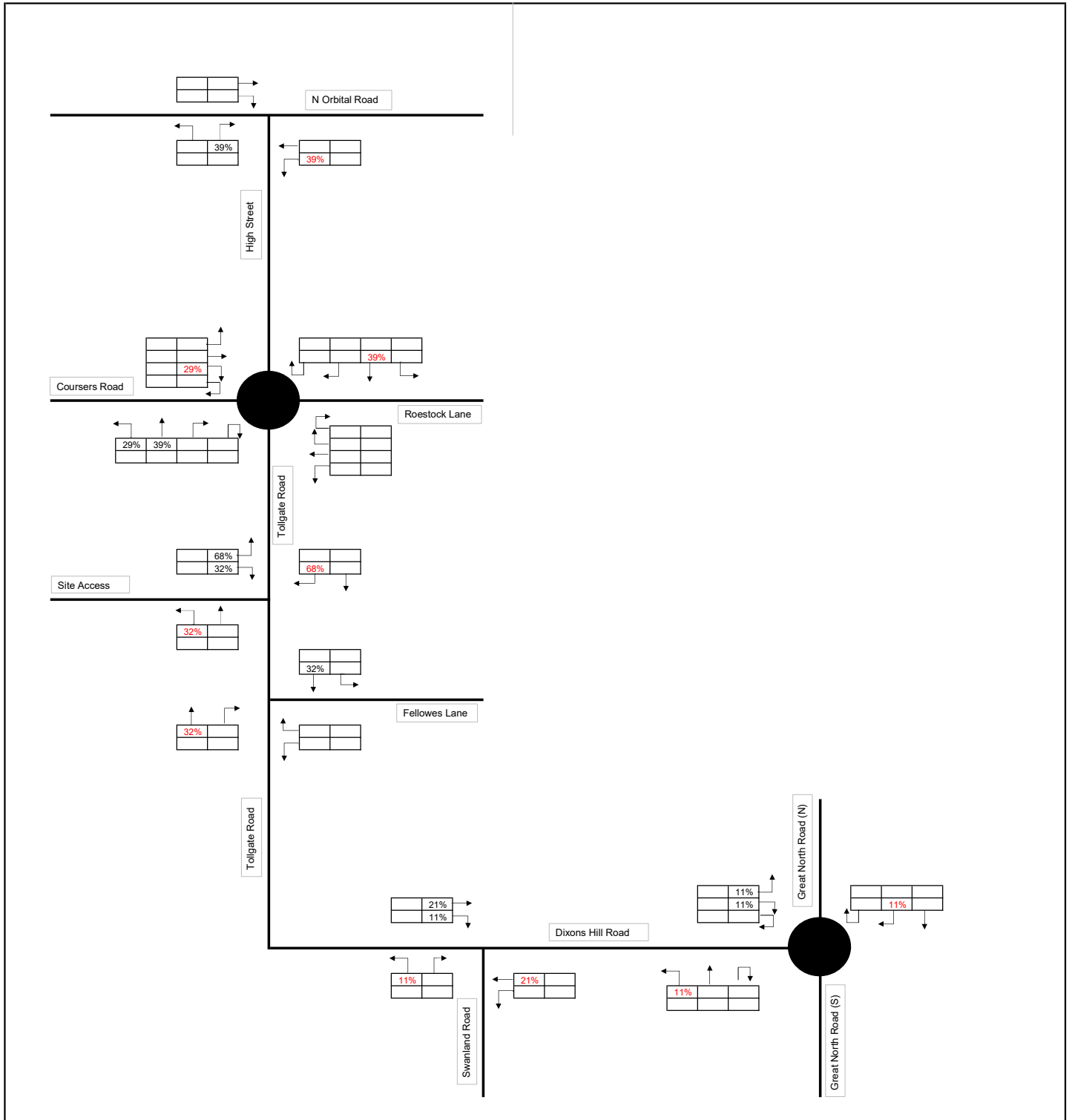

Notes

Project Name: Colney Heath
 Job Number: JNY11289
 Title
 Residential Trip Distribution

(%) Departures
 (%) Arrivals

Figure No. 5

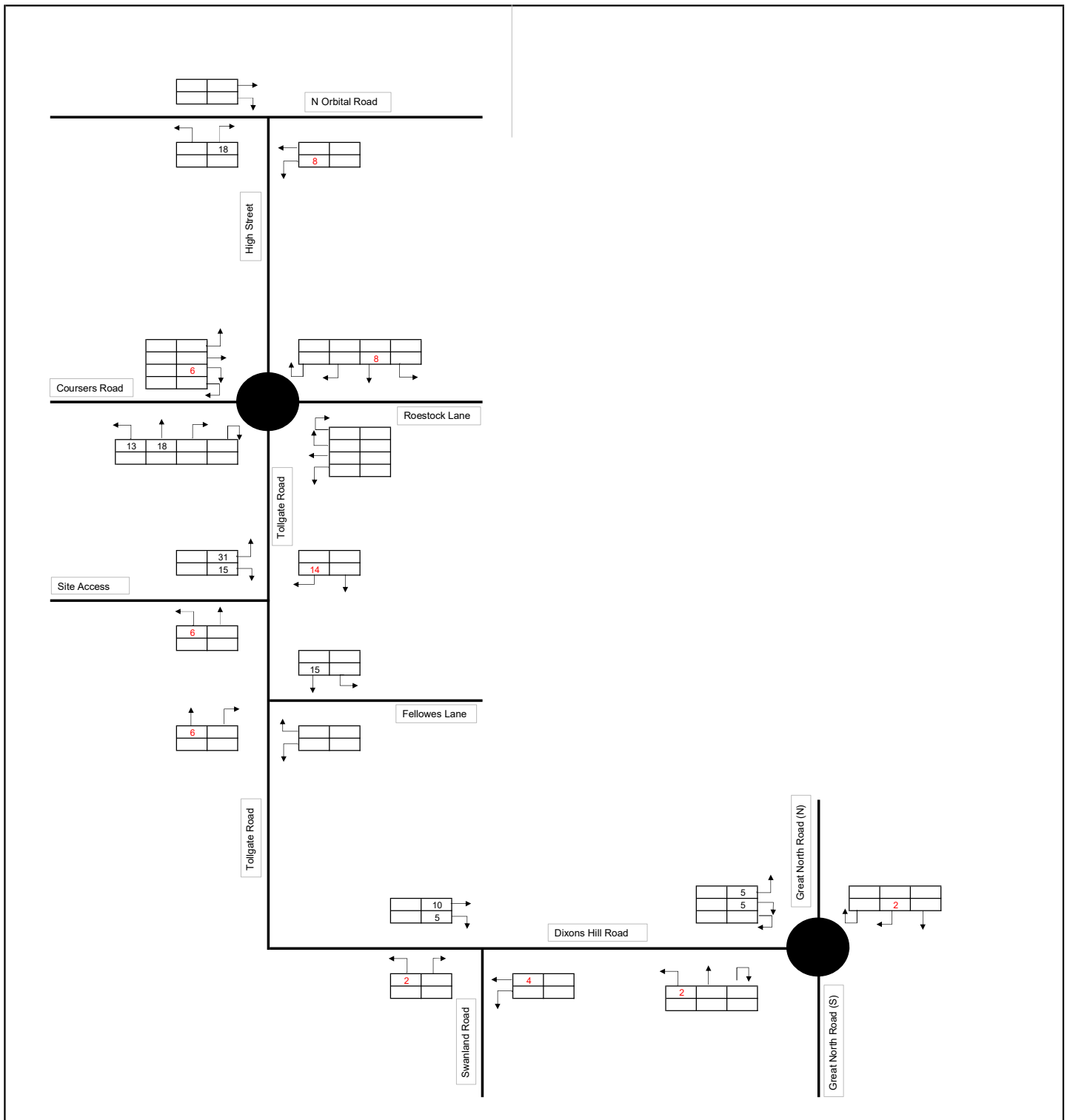

Notes

Project Name: Colney Heath
 Job Number: JNY11289
 Title
 Residential Trip Generation
 AM Peak (08:00-09:00)
 Figure No. 6

(x) Departures
 (x) Arrivals

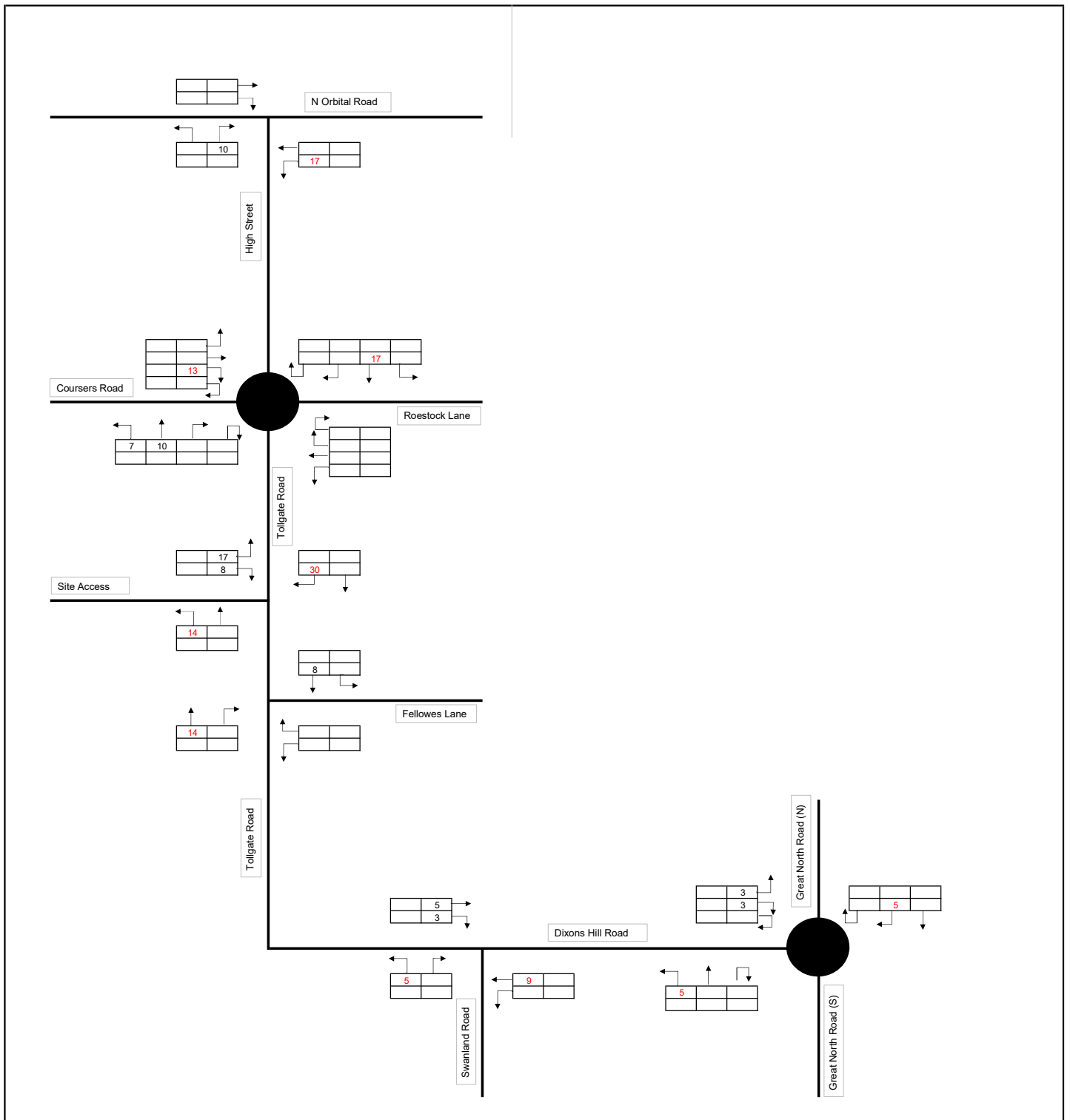

Notes

Project Name: Colney Heath
 Job Number: JNY11289
 Title
 Residential Trip Generation
 PM Peak (17:00-18:00)
 Figure No. 7

(x) Departures
 (x) Arrivals

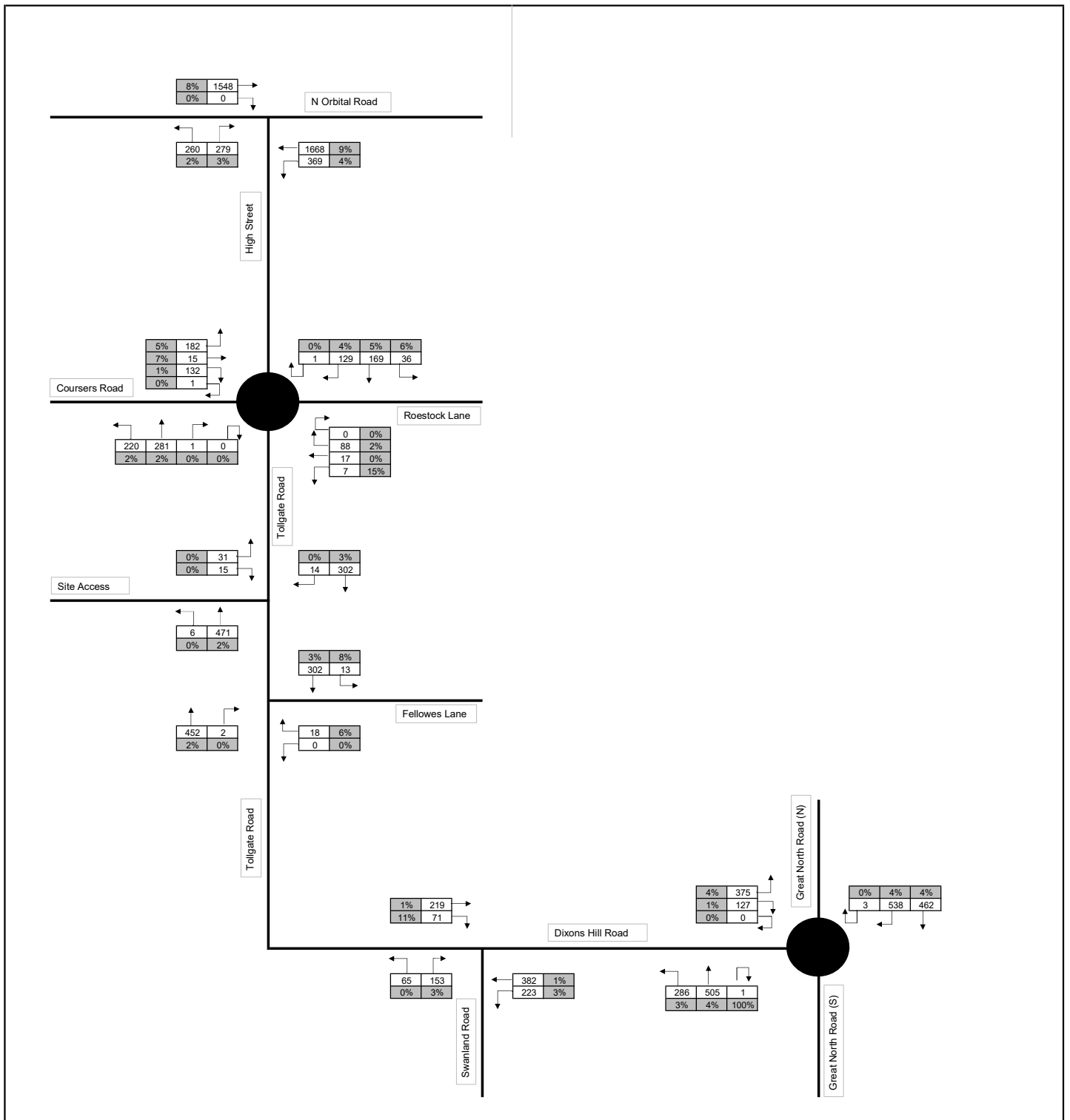

Notes

Project Name: Colney Heath
 Job Number: JNY11289
 Title
 2027 Base + Development Flows
 AM Peak (08:00-09:00)
 Figure No. 8

Total Vehicles
 HGVs (%)

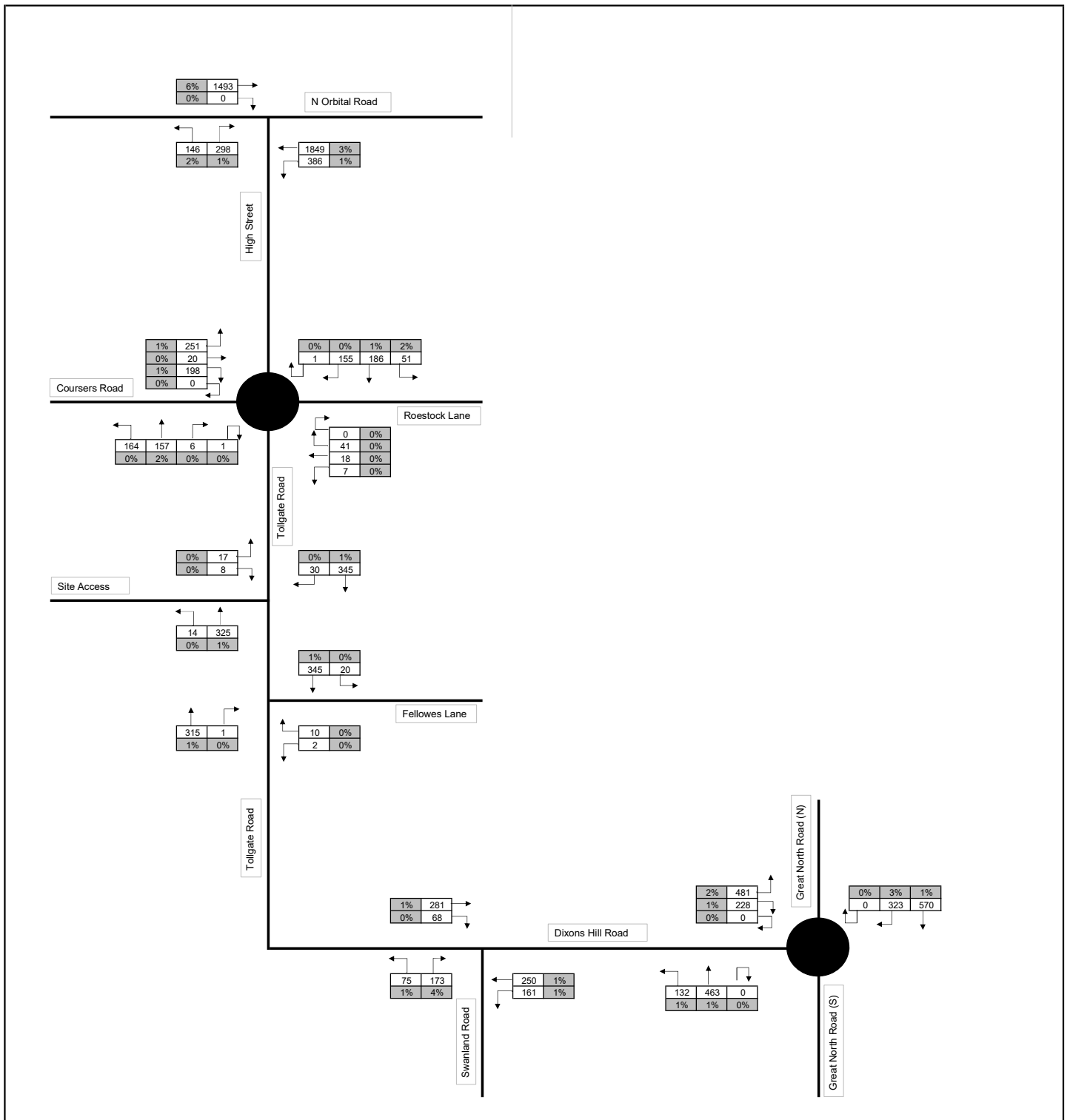

Notes

Project Name: Colney Heath
 Job Number: JNY11289
 Title
 2027 Base + Development Flows
 PM Peak (17:00-18:00)
 Figure No. 9

Total Vehicles
 HGVs (%)

Appendix 14 – LINSIG Outputs

Full Input Data And Results
Full Input Data And Results

User and Project Details

Project:	JNY11289 - Colney Heath
Title:	A414 N Orbital Rd_High Street Signalised Junction
Location:	
Additional detail:	
File name:	A414 N Orbital Rd_High Street Signalised Junction.lsg3x
Author:	George Magnisalis
Company:	RPS Group
Address:	

Network Layout Diagram

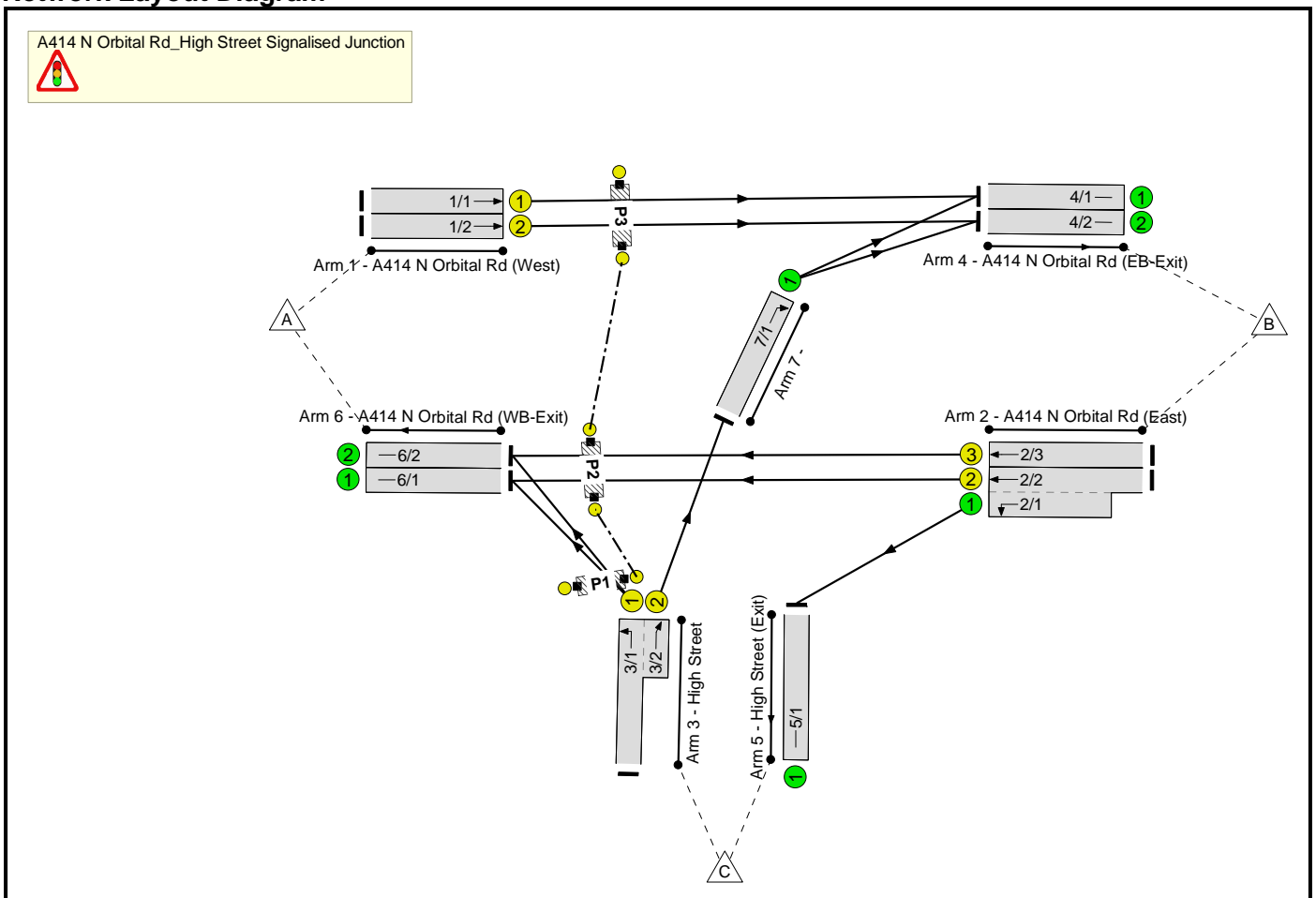

Phase Diagram

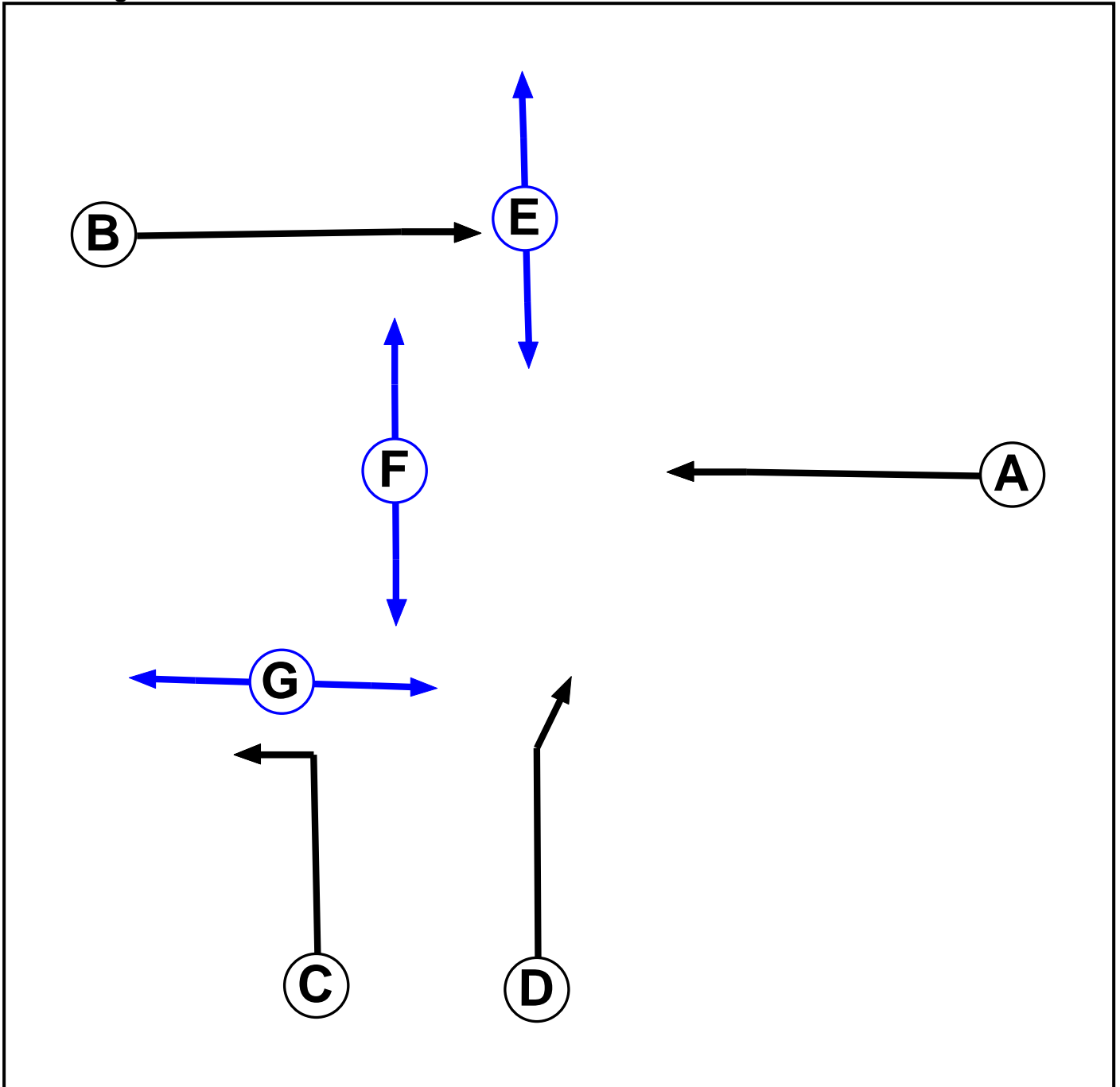

Phase Input Data

Phase Name	Phase Type	Assoc. Phase	Street Min	Cont Min
A	Traffic		7	7
B	Traffic		7	7
C	Traffic		7	7
D	Traffic		7	7
E	Pedestrian		5	5
F	Pedestrian		5	5
G	Pedestrian		5	5

Full Input Data And Results

Phase Intergrens Matrix

		Starting Phase						
		A	B	C	D	E	F	G
Terminating Phase	A	-	-	7	5	-	7	-
	B	-	-	-	5	5	-	-
	C	5	-	-	-	-	-	5
	D	5	6	-	-	-	-	-
	E	-	11	-	-	-	-	-
	F	10	-	-	-	-	-	-
	G	-	-	10	-	-	-	-

Phases in Stage

Stage No.	Phases in Stage
1	A B G
2	B C F
3	C D E F

Stage Diagram

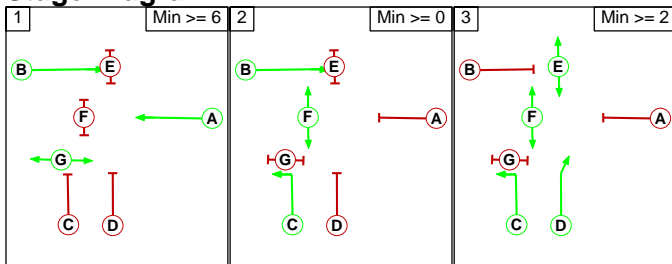

Phase Delays

Term. Stage	Start Stage	Phase	Type	Value	Cont value
There are no Phase Delays defined					

Prohibited Stage Change

		To Stage		
		1	2	3
From Stage	1	-	10	10
	2	10	-	5
	3	11	11	-

Full Input Data And Results

Give-Way Lane Input Data

Junction: A414 N Orbital Rd_High Street Signalised Junction

There are no Opposed Lanes in this Junction

Full Input Data And Results

Lane Input Data

Junction: A414 N Orbital Rd_High Street Signalised Junction												
Lane	Lane Type	Phases	Start Disp.	End Disp.	Physical Length (PCU)	Sat Flow Type	Def User Saturation Flow (PCU/Hr)	Lane Width (m)	Gradient	Nearside Lane	Turns	Turning Radius (m)
1/1 (A414 N Orbital Rd (West))	U	B	2	3	27.8	Geom	-	3.65	0.00	Y	Arm 4 Ahead	Inf
1/2 (A414 N Orbital Rd (West))	U	B	2	3	27.8	Geom	-	3.65	0.00	Y	Arm 4 Ahead	Inf
2/1 (A414 N Orbital Rd (East))	U		2	3	13.2	Geom	-	3.50	0.00	Y	Arm 5 Left	Inf
2/2 (A414 N Orbital Rd (East))	U	A	2	3	26.1	Geom	-	3.50	0.00	N	Arm 6 Ahead	Inf
2/3 (A414 N Orbital Rd (East))	U	A	2	3	26.1	Geom	-	3.50	0.00	Y	Arm 6 Ahead	Inf
3/1 (High Street)	U	C	2	3	60.0	Geom	-	3.50	0.00	Y	Arm 6 Left	Inf
3/2 (High Street)	U	D	2	3	3.5	Geom	-	4.00	0.00	Y	Arm 7 Ahead	Inf
4/1 (A414 N Orbital Rd (EB-Exit))	U		2	3	60.0	Inf	-	-	-	-	-	-
4/2 (A414 N Orbital Rd (EB-Exit))	U		2	3	60.0	Inf	-	-	-	-	-	-
5/1 (High Street (Exit))	U		2	3	60.0	Inf	-	-	-	-	-	-
6/1 (A414 N Orbital Rd (WB-Exit))	U		2	3	60.0	Inf	-	-	-	-	-	-
6/2 (A414 N Orbital Rd (WB-Exit))	U		2	3	60.0	Inf	-	-	-	-	-	-
7/1	U		2	3	1.9	Geom	-	4.20	0.00	Y	Arm 4 Right	Inf

Full Input Data And Results

Traffic Flow Groups

Flow Group	Start Time	End Time	Duration	Formula
1: '2022 Base AM Peak'	08:00	09:00	01:00	
2: '2022 Base PM Peak'	17:00	18:00	01:00	
3: '2027 Base AM Peak'	08:00	09:00	01:00	
4: '2027 Base PM Peak'	17:00	18:00	01:00	
5: '2027 Base + Dev AM Peak'	08:00	09:00	01:00	
6: '2027 Base + Dev PM Peak'	17:00	18:00	01:00	

Scenario 1: '2022 Base AM Peak' (FG1: '2022 Base AM Peak', Plan 1: 'Network Control Plan 1')

Traffic Flows, Desired

Desired Flow :

	Destination				
		A	B	C	Tot.
Origin	A	0	1681	0	1681
	B	1824	0	374	2198
	C	262	266	0	528
	Tot.	2086	1947	374	4407

Traffic Lane Flows

Lane	Scenario 1: 2022 Base AM Peak
Junction: A414 N Orbital Rd_High Street Signalised Junction	
1/1	841
1/2	840
2/1 (short)	374
2/2 (with short)	1254(In) 880(Out)
2/3	944
3/1 (with short)	528(In) 262(Out)
3/2 (short)	266
4/1	1107
4/2	840
5/1	374
6/1	1011
6/2	1075
7/1	266

Lane Saturation Flows

Junction: A414 N Orbital Rd_High Street Signalised Junction								
Lane	Lane Width (m)	Gradient	Nearside Lane	Allowed Turns	Turning Radius (m)	Turning Prop.	Sat Flow (PCU/Hr)	Flared Sat Flow (PCU/Hr)
1/1 (A414 N Orbital Rd (West))	3.65	0.00	Y	Arm 4 Ahead	Inf	100.0 %	1980	1980
1/2 (A414 N Orbital Rd (West))	3.65	0.00	Y	Arm 4 Ahead	Inf	100.0 %	1980	1980
2/1 (A414 N Orbital Rd (East))	3.50	0.00	Y	Arm 5 Left	Inf	100.0 %	1965	1965
2/2 (A414 N Orbital Rd (East))	3.50	0.00	N	Arm 6 Ahead	Inf	100.0 %	2105	2105
2/3 (A414 N Orbital Rd (East))	3.50	0.00	Y	Arm 6 Ahead	Inf	100.0 %	1965	1965
3/1 (High Street)	3.50	0.00	Y	Arm 6 Left	Inf	100.0 %	1965	1965
3/2 (High Street)	4.00	0.00	Y	Arm 7 Ahead	Inf	100.0 %	2015	2015
4/1 (A414 N Orbital Rd (EB-Exit) Lane 1)				Infinite Saturation Flow			Inf	Inf
4/2 (A414 N Orbital Rd (EB-Exit) Lane 2)				Infinite Saturation Flow			Inf	Inf
5/1 (High Street (Exit) Lane 1)				Infinite Saturation Flow			Inf	Inf
6/1 (A414 N Orbital Rd (WB-Exit) Lane 1)				Infinite Saturation Flow			Inf	Inf
6/2 (A414 N Orbital Rd (WB-Exit) Lane 2)				Infinite Saturation Flow			Inf	Inf
7/1	4.20	0.00	Y	Arm 4 Right	Inf	100.0 %	2035	2035

Scenario 2: '2022 Base PM Peak' (FG2: '2022 Base PM Peak', Plan 1: 'Network Control Plan 1')

Traffic Flows, Desired

Desired Flow :

	Destination				
		A	B	C	Tot.
Origin	A	0	1579	0	1579
	B	1894	0	365	2259
	C	148	288	0	436
	Tot.	2042	1867	365	4274

Full Input Data And Results

Traffic Lane Flows

Lane	Scenario 2: 2022 Base PM Peak
Junction: A414 N Orbital Rd_High Street Signalised Junction	
1/1	790
1/2	789
2/1 (short)	365
2/2 (with short)	1280(In) 915(Out)
2/3	979
3/1 (with short)	436(In) 148(Out)
3/2 (short)	288
4/1	1078
4/2	789
5/1	365
6/1	989
6/2	1053
7/1	288

Lane Saturation Flows

Junction: A414 N Orbital Rd_High Street Signalised Junction								
Lane	Lane Width (m)	Gradient	Nearside Lane	Allowed Turns	Turning Radius (m)	Turning Prop.	Sat Flow (PCU/Hr)	Flared Sat Flow (PCU/Hr)
1/1 (A414 N Orbital Rd (West))	3.65	0.00	Y	Arm 4 Ahead	Inf	100.0 %	1980	1980
1/2 (A414 N Orbital Rd (West))	3.65	0.00	Y	Arm 4 Ahead	Inf	100.0 %	1980	1980
2/1 (A414 N Orbital Rd (East))	3.50	0.00	Y	Arm 5 Left	Inf	100.0 %	1965	1965
2/2 (A414 N Orbital Rd (East))	3.50	0.00	N	Arm 6 Ahead	Inf	100.0 %	2105	2105
2/3 (A414 N Orbital Rd (East))	3.50	0.00	Y	Arm 6 Ahead	Inf	100.0 %	1965	1965
3/1 (High Street)	3.50	0.00	Y	Arm 6 Left	Inf	100.0 %	1965	1965
3/2 (High Street)	4.00	0.00	Y	Arm 7 Ahead	Inf	100.0 %	2015	2015
4/1 (A414 N Orbital Rd (EB-Exit) Lane 1)				Infinite Saturation Flow			Inf	Inf
4/2 (A414 N Orbital Rd (EB-Exit) Lane 2)				Infinite Saturation Flow			Inf	Inf
5/1 (High Street (Exit) Lane 1)				Infinite Saturation Flow			Inf	Inf
6/1 (A414 N Orbital Rd (WB-Exit) Lane 1)				Infinite Saturation Flow			Inf	Inf
6/2 (A414 N Orbital Rd (WB-Exit) Lane 2)				Infinite Saturation Flow			Inf	Inf
7/1	4.20	0.00	Y	Arm 4 Right	Inf	100.0 %	2035	2035

Scenario 3: '2027 Base AM Peak' (FG3: '2027 Base AM Peak', Plan 1: 'Network Control Plan 1')

Traffic Flows, Desired

Desired Flow :

	Destination				
		A	B	C	Tot.
Origin	A	0	1707	0	1707
	B	1853	0	380	2233
	C	266	270	0	536
	Tot.	2119	1977	380	4476

Full Input Data And Results

Traffic Lane Flows

Lane	Scenario 3: 2027 Base AM Peak
Junction: A414 N Orbital Rd_High Street Signalised Junction	
1/1	854
1/2	853
2/1 (short)	380
2/2 (with short)	1271(In) 891(Out)
2/3	962
3/1 (with short)	536(In) 266(Out)
3/2 (short)	270
4/1	1124
4/2	853
5/1	380
6/1	1024
6/2	1095
7/1	270

Lane Saturation Flows

Junction: A414 N Orbital Rd_High Street Signalised Junction								
Lane	Lane Width (m)	Gradient	Nearside Lane	Allowed Turns	Turning Radius (m)	Turning Prop.	Sat Flow (PCU/Hr)	Flared Sat Flow (PCU/Hr)
1/1 (A414 N Orbital Rd (West))	3.65	0.00	Y	Arm 4 Ahead	Inf	100.0 %	1980	1980
1/2 (A414 N Orbital Rd (West))	3.65	0.00	Y	Arm 4 Ahead	Inf	100.0 %	1980	1980
2/1 (A414 N Orbital Rd (East))	3.50	0.00	Y	Arm 5 Left	Inf	100.0 %	1965	1965
2/2 (A414 N Orbital Rd (East))	3.50	0.00	N	Arm 6 Ahead	Inf	100.0 %	2105	2105
2/3 (A414 N Orbital Rd (East))	3.50	0.00	Y	Arm 6 Ahead	Inf	100.0 %	1965	1965
3/1 (High Street)	3.50	0.00	Y	Arm 6 Left	Inf	100.0 %	1965	1965
3/2 (High Street)	4.00	0.00	Y	Arm 7 Ahead	Inf	100.0 %	2015	2015
4/1 (A414 N Orbital Rd (EB-Exit) Lane 1)				Infinite Saturation Flow			Inf	Inf
4/2 (A414 N Orbital Rd (EB-Exit) Lane 2)				Infinite Saturation Flow			Inf	Inf
5/1 (High Street (Exit) Lane 1)				Infinite Saturation Flow			Inf	Inf
6/1 (A414 N Orbital Rd (WB-Exit) Lane 1)				Infinite Saturation Flow			Inf	Inf
6/2 (A414 N Orbital Rd (WB-Exit) Lane 2)				Infinite Saturation Flow			Inf	Inf
7/1	4.20	0.00	Y	Arm 4 Right	Inf	100.0 %	2035	2035

Scenario 4: '2027 Base PM Peak' (FG4: '2027 Base PM Peak', Plan 1: 'Network Control Plan 1')

Traffic Flows, Desired

Desired Flow :

	Destination				
		A	B	C	Tot.
Origin	A	0	1604	0	1604
	B	1924	0	371	2295
	C	150	293	0	443
	Tot.	2074	1897	371	4342

Full Input Data And Results

Traffic Lane Flows

Lane	Scenario 4: 2027 Base PM Peak
Junction: A414 N Orbital Rd_High Street Signalised Junction	
1/1	802
1/2	802
2/1 (short)	371
2/2 (with short)	1297(In) 926(Out)
2/3	998
3/1 (with short)	443(In) 150(Out)
3/2 (short)	293
4/1	1095
4/2	802
5/1	371
6/1	1001
6/2	1073
7/1	293

Lane Saturation Flows

Junction: A414 N Orbital Rd_High Street Signalised Junction								
Lane	Lane Width (m)	Gradient	Nearside Lane	Allowed Turns	Turning Radius (m)	Turning Prop.	Sat Flow (PCU/Hr)	Flared Sat Flow (PCU/Hr)
1/1 (A414 N Orbital Rd (West))	3.65	0.00	Y	Arm 4 Ahead	Inf	100.0 %	1980	1980
1/2 (A414 N Orbital Rd (West))	3.65	0.00	Y	Arm 4 Ahead	Inf	100.0 %	1980	1980
2/1 (A414 N Orbital Rd (East))	3.50	0.00	Y	Arm 5 Left	Inf	100.0 %	1965	1965
2/2 (A414 N Orbital Rd (East))	3.50	0.00	N	Arm 6 Ahead	Inf	100.0 %	2105	2105
2/3 (A414 N Orbital Rd (East))	3.50	0.00	Y	Arm 6 Ahead	Inf	100.0 %	1965	1965
3/1 (High Street)	3.50	0.00	Y	Arm 6 Left	Inf	100.0 %	1965	1965
3/2 (High Street)	4.00	0.00	Y	Arm 7 Ahead	Inf	100.0 %	2015	2015
4/1 (A414 N Orbital Rd (EB-Exit) Lane 1)				Infinite Saturation Flow			Inf	Inf
4/2 (A414 N Orbital Rd (EB-Exit) Lane 2)				Infinite Saturation Flow			Inf	Inf
5/1 (High Street (Exit) Lane 1)				Infinite Saturation Flow			Inf	Inf
6/1 (A414 N Orbital Rd (WB-Exit) Lane 1)				Infinite Saturation Flow			Inf	Inf
6/2 (A414 N Orbital Rd (WB-Exit) Lane 2)				Infinite Saturation Flow			Inf	Inf
7/1	4.20	0.00	Y	Arm 4 Right	Inf	100.0 %	2035	2035

Scenario 5: '2027 Base + Dev AM Peak' (FG5: '2027 Base + Dev AM Peak', Plan 1: 'Network Control Plan 1')

Traffic Flows, Desired

Desired Flow :

	Destination				
		A	B	C	Tot.
Origin	A	0	1707	0	1707
	B	1853	0	388	2241
	C	266	288	0	554
	Tot.	2119	1995	388	4502

Full Input Data And Results

Traffic Lane Flows

Lane	Scenario 5: 2027 Base + Dev AM Peak
Junction: A414 N Orbital Rd_High Street Signalised Junction	
1/1	854
1/2	853
2/1 (short)	388
2/2 (with short)	1278(In) 890(Out)
2/3	963
3/1 (with short)	554(In) 266(Out)
3/2 (short)	288
4/1	1142
4/2	853
5/1	388
6/1	1023
6/2	1096
7/1	288

Lane Saturation Flows

Junction: A414 N Orbital Rd_High Street Signalised Junction								
Lane	Lane Width (m)	Gradient	Nearside Lane	Allowed Turns	Turning Radius (m)	Turning Prop.	Sat Flow (PCU/Hr)	Flared Sat Flow (PCU/Hr)
1/1 (A414 N Orbital Rd (West))	3.65	0.00	Y	Arm 4 Ahead	Inf	100.0 %	1980	1980
1/2 (A414 N Orbital Rd (West))	3.65	0.00	Y	Arm 4 Ahead	Inf	100.0 %	1980	1980
2/1 (A414 N Orbital Rd (East))	3.50	0.00	Y	Arm 5 Left	Inf	100.0 %	1965	1965
2/2 (A414 N Orbital Rd (East))	3.50	0.00	N	Arm 6 Ahead	Inf	100.0 %	2105	2105
2/3 (A414 N Orbital Rd (East))	3.50	0.00	Y	Arm 6 Ahead	Inf	100.0 %	1965	1965
3/1 (High Street)	3.50	0.00	Y	Arm 6 Left	Inf	100.0 %	1965	1965
3/2 (High Street)	4.00	0.00	Y	Arm 7 Ahead	Inf	100.0 %	2015	2015
4/1 (A414 N Orbital Rd (EB-Exit) Lane 1)				Infinite Saturation Flow			Inf	Inf
4/2 (A414 N Orbital Rd (EB-Exit) Lane 2)				Infinite Saturation Flow			Inf	Inf
5/1 (High Street (Exit) Lane 1)				Infinite Saturation Flow			Inf	Inf
6/1 (A414 N Orbital Rd (WB-Exit) Lane 1)				Infinite Saturation Flow			Inf	Inf
6/2 (A414 N Orbital Rd (WB-Exit) Lane 2)				Infinite Saturation Flow			Inf	Inf
7/1	4.20	0.00	Y	Arm 4 Right	Inf	100.0 %	2035	2035

Scenario 6: '2027 Base + Dev PM Peak' (FG6: '2027 Base + Dev PM Peak', Plan 1: 'Network Control Plan 1')

Traffic Flows, Desired

Desired Flow :

	Destination				
		A	B	C	Tot.
Origin	A	0	1604	0	1604
	B	1924	0	388	2312
	C	150	303	0	453
	Tot.	2074	1907	388	4369

Full Input Data And Results

Traffic Lane Flows

Lane	Scenario 6: 2027 Base + Dev PM Peak
Junction: A414 N Orbital Rd_High Street Signalised Junction	
1/1	802
1/2	802
2/1 (short)	388
2/2 (with short)	1309(In) 921(Out)
2/3	1003
3/1 (with short)	453(In) 150(Out)
3/2 (short)	303
4/1	1105
4/2	802
5/1	388
6/1	996
6/2	1078
7/1	303

Lane Saturation Flows

Junction: A414 N Orbital Rd_High Street Signalised Junction								
Lane	Lane Width (m)	Gradient	Nearside Lane	Allowed Turns	Turning Radius (m)	Turning Prop.	Sat Flow (PCU/Hr)	Flared Sat Flow (PCU/Hr)
1/1 (A414 N Orbital Rd (West))	3.65	0.00	Y	Arm 4 Ahead	Inf	100.0 %	1980	1980
1/2 (A414 N Orbital Rd (West))	3.65	0.00	Y	Arm 4 Ahead	Inf	100.0 %	1980	1980
2/1 (A414 N Orbital Rd (East))	3.50	0.00	Y	Arm 5 Left	Inf	100.0 %	1965	1965
2/2 (A414 N Orbital Rd (East))	3.50	0.00	N	Arm 6 Ahead	Inf	100.0 %	2105	2105
2/3 (A414 N Orbital Rd (East))	3.50	0.00	Y	Arm 6 Ahead	Inf	100.0 %	1965	1965
3/1 (High Street)	3.50	0.00	Y	Arm 6 Left	Inf	100.0 %	1965	1965
3/2 (High Street)	4.00	0.00	Y	Arm 7 Ahead	Inf	100.0 %	2015	2015
4/1 (A414 N Orbital Rd (EB-Exit) Lane 1)				Infinite Saturation Flow			Inf	Inf
4/2 (A414 N Orbital Rd (EB-Exit) Lane 2)				Infinite Saturation Flow			Inf	Inf
5/1 (High Street (Exit) Lane 1)				Infinite Saturation Flow			Inf	Inf
6/1 (A414 N Orbital Rd (WB-Exit) Lane 1)				Infinite Saturation Flow			Inf	Inf
6/2 (A414 N Orbital Rd (WB-Exit) Lane 2)				Infinite Saturation Flow			Inf	Inf
7/1	4.20	0.00	Y	Arm 4 Right	Inf	100.0 %	2035	2035

Scenario 1: '2022 Base AM Peak' (FG1: '2022 Base AM Peak', Plan 1: 'Network Control Plan 1')

Stage Sequence Diagram

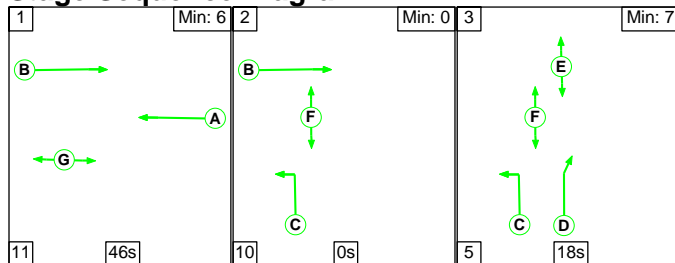

Stage Timings

Stage	1	2	3
Duration	46	0	18
Change Point	0	57	67

Signal Timings Diagram

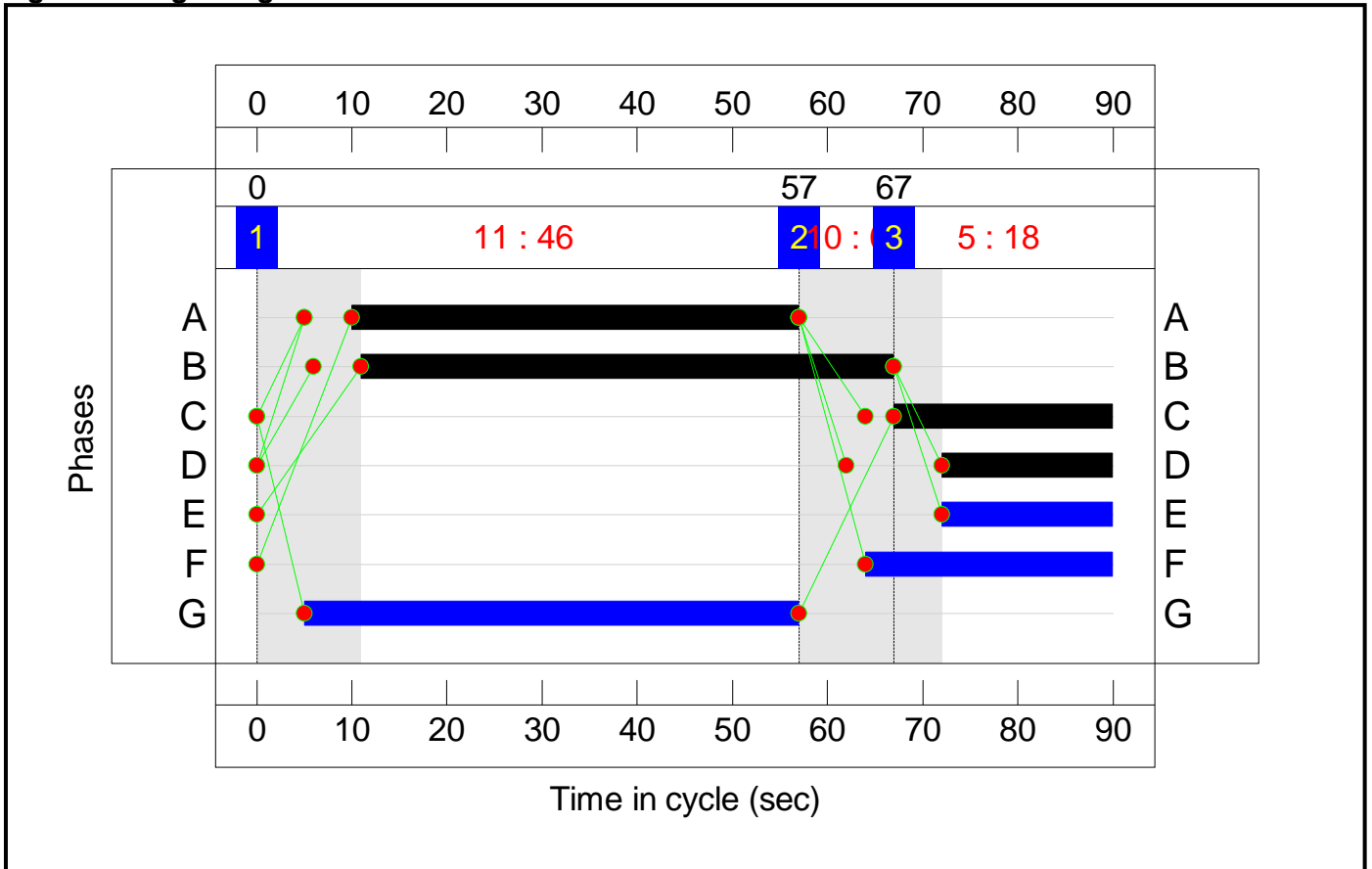

Full Input Data And Results
Network Layout Diagram

Full Input Data And Results

A414 N Orbital Rd_High Street Signalised Junction

PRC: -3.6 %
 Total Traffic Delay: 35.6 pcuHr
 Ave. Route Delay Per Ped: 0.0 s/Ped

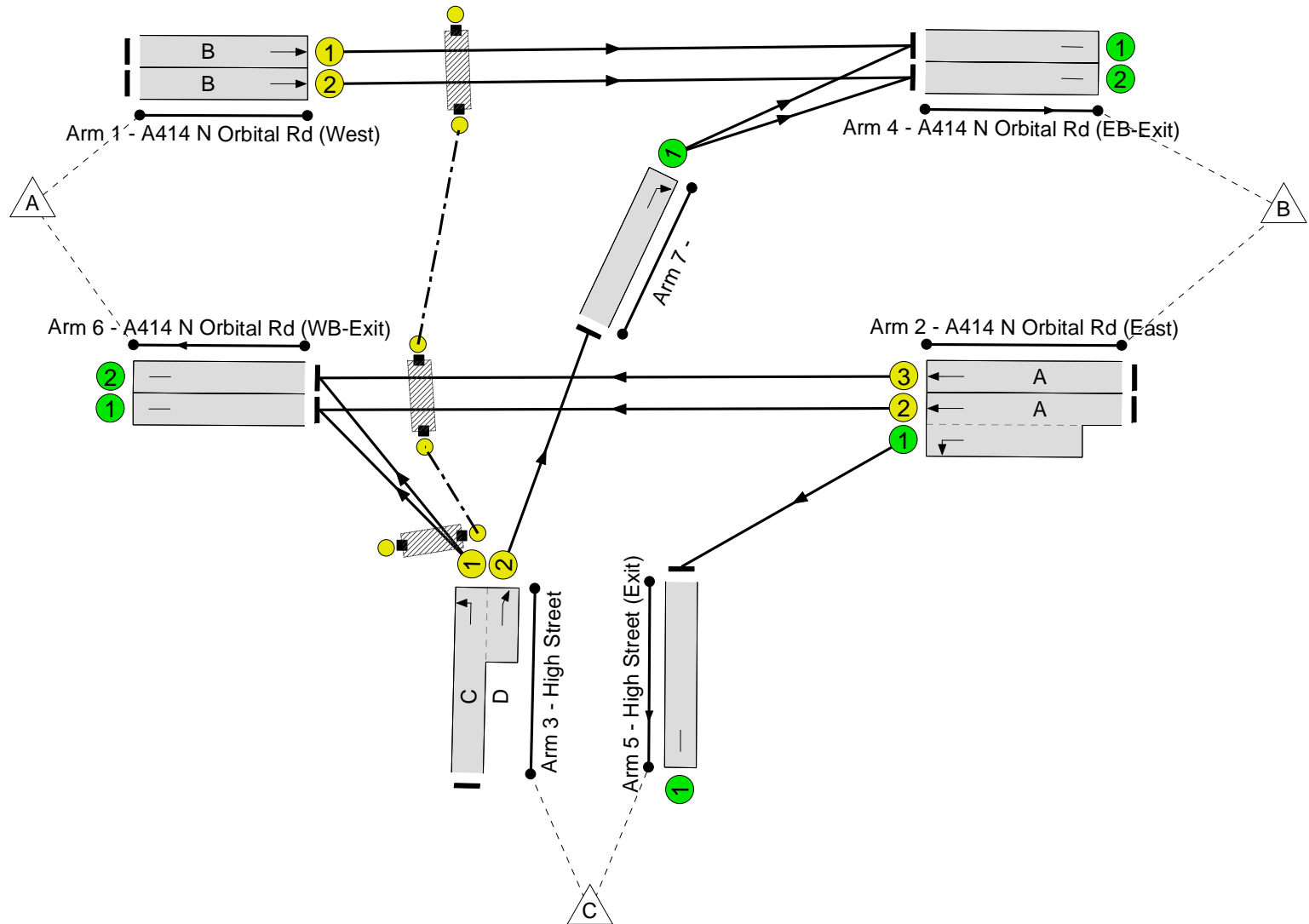
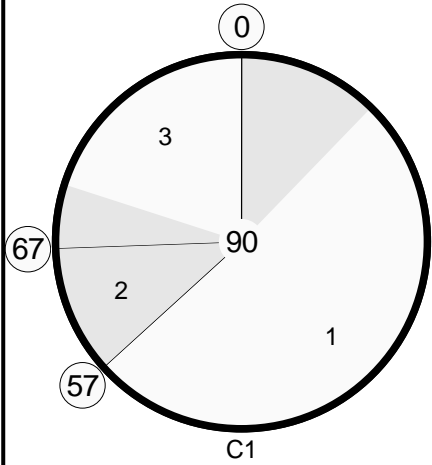

Full Input Data And Results

Full Input Data And Results

Network Results

Full Input Data And Results

Item	Lane Description	Lane Type	Controller Stream	Position In Filtered Route	Full Phase	Arrow Phase	Num Greens	Total Green (s)	Arrow Green (s)	Demand Flow (pcu)	Sat Flow (pcu/Hr)	Capacity (pcu)	Deg Sat (%)
Network: A414 N Orbital Rd_High Street Signalised Junction	-	-	N/A	-	-		-	-	-	-	-	-	93.3%
A414 N Orbital Rd_High Street Signalised Junction	-	-	N/A	-	-		-	-	-	-	-	-	93.3%
1/1	A414 N Orbital Rd (West) Ahead	U	N/A	N/A	B		1	56	-	841	1980	1254	67.1%
1/2	A414 N Orbital Rd (West) Ahead	U	N/A	N/A	B		1	56	-	840	1980	1254	67.0%
2/2+2/1	A414 N Orbital Rd (East) Left Ahead	U	N/A	N/A	A -		1	47	-	1254	2105:1965	944+401	93.3 : 93.3%
2/3	A414 N Orbital Rd (East) Ahead	U	N/A	N/A	A		1	47	-	944	1965	1048	90.1%
3/1+3/2	High Street Left Ahead	U	N/A	N/A	C D		1	23:18	-	528	1965:2015	288+292	91.0 : 91.0%
4/1	A414 N Orbital Rd (EB-Exit)	U	N/A	N/A	-		-	-	-	1107	Inf	Inf	0.0%
4/2	A414 N Orbital Rd (EB-Exit)	U	N/A	N/A	-		-	-	-	840	Inf	Inf	0.0%
5/1	High Street (Exit)	U	N/A	N/A	-		-	-	-	374	Inf	Inf	0.0%
6/1	A414 N Orbital Rd (WB-Exit)	U	N/A	N/A	-		-	-	-	1011	Inf	Inf	0.0%
6/2	A414 N Orbital Rd (WB-Exit)	U	N/A	N/A	-		-	-	-	1075	Inf	Inf	0.0%
7/1	Right	U	N/A	N/A	-		-	-	-	266	2035	2035	13.1%
Ped Link: P1	Unnamed Ped Link	-	N/A	-	G		1	52	-	0	-	0	0.0%
Ped Link: P2	Unnamed Ped Link	-	N/A	-	F		1	26	-	0	-	0	0.0%
Ped Link: P3	Unnamed Ped Link	-	N/A	-	E		1	18	-	0	-	0	0.0%

Full Input Data And Results

Item	Arriving (pcu)	Leaving (pcu)	Turners In Gaps (pcu)	Turners When Unopposed (pcu)	Turners In Intergreen (pcu)	Uniform Delay (pcuHr)	Rand + Oversat Delay (pcuHr)	Storage Area Uniform Delay (pcuHr)	Total Delay (pcuHr)	Av. Delay Per PCU (s/pcu)	Max. Back of Uniform Queue (pcu)	Rand + Oversat Queue (pcu)	Mean Max Queue (pcu)
Network: A414 N Orbital Rd_High Street Signalised Junction	-	-	0	0	0	18.9	16.7	0.0	35.6	-	-	-	-
A414 N Orbital Rd_High Street Signalised Junction	-	-	0	0	0	18.9	16.7	0.0	35.6	-	-	-	-
1/1	841	841	-	-	-	2.5	1.0	-	3.5	14.9	13.3	1.0	14.3
1/2	840	840	-	-	-	2.5	1.0	-	3.5	14.8	13.3	1.0	14.3
2/2+2/1	1254	1254	-	-	-	4.4	6.1	-	10.5	30.1	22.3	6.1	28.4
2/3	944	944	-	-	-	4.9	4.2	-	9.1	34.9	21.0	4.2	25.2
3/1+3/2	528	528	-	-	-	4.6	4.3	-	9.0	61.2	9.2	4.3	13.5
4/1	1107	1107	-	-	-	0.0	0.0	-	0.0	0.0	0.0	0.0	0.0
4/2	840	840	-	-	-	0.0	0.0	-	0.0	0.0	0.0	0.0	0.0
5/1	374	374	-	-	-	0.0	0.0	-	0.0	0.0	0.0	0.0	0.0
6/1	1011	1011	-	-	-	0.0	0.0	-	0.0	0.0	0.0	0.0	0.0
6/2	1075	1075	-	-	-	0.0	0.0	-	0.0	0.0	0.0	0.0	0.0
7/1	266	266	-	-	-	0.0	0.1	-	0.1	1.0	0.0	0.1	0.1
Ped Link: P1	0	0	-	-	-	-	-	-	-	-	-	-	-
Ped Link: P2	0	0	-	-	-	-	-	-	-	-	-	-	-
Ped Link: P3	0	0	-	-	-	-	-	-	-	-	-	-	-
C1			PRC for Signalled Lanes (%):		-3.6	Total Delay for Signalled Lanes (pcuHr):		35.53	Cycle Time (s): 90				
			PRC Over All Lanes (%):		-3.6	Total Delay Over All Lanes(pcuHr):		35.60					

Full Input Data And Results

Scenario 2: '2022 Base PM Peak' (FG2: '2022 Base PM Peak', Plan 1: 'Network Control Plan 1')

Stage Sequence Diagram

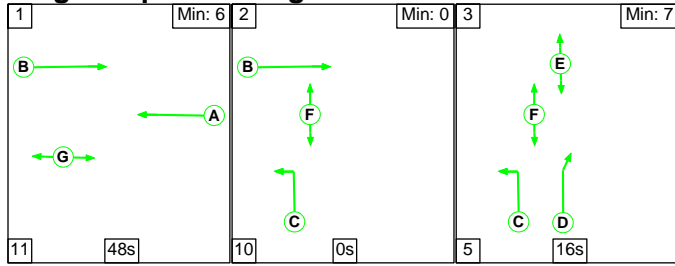

Stage Timings

Stage	1	2	3
Duration	48	0	16
Change Point	0	59	69

Signal Timings Diagram

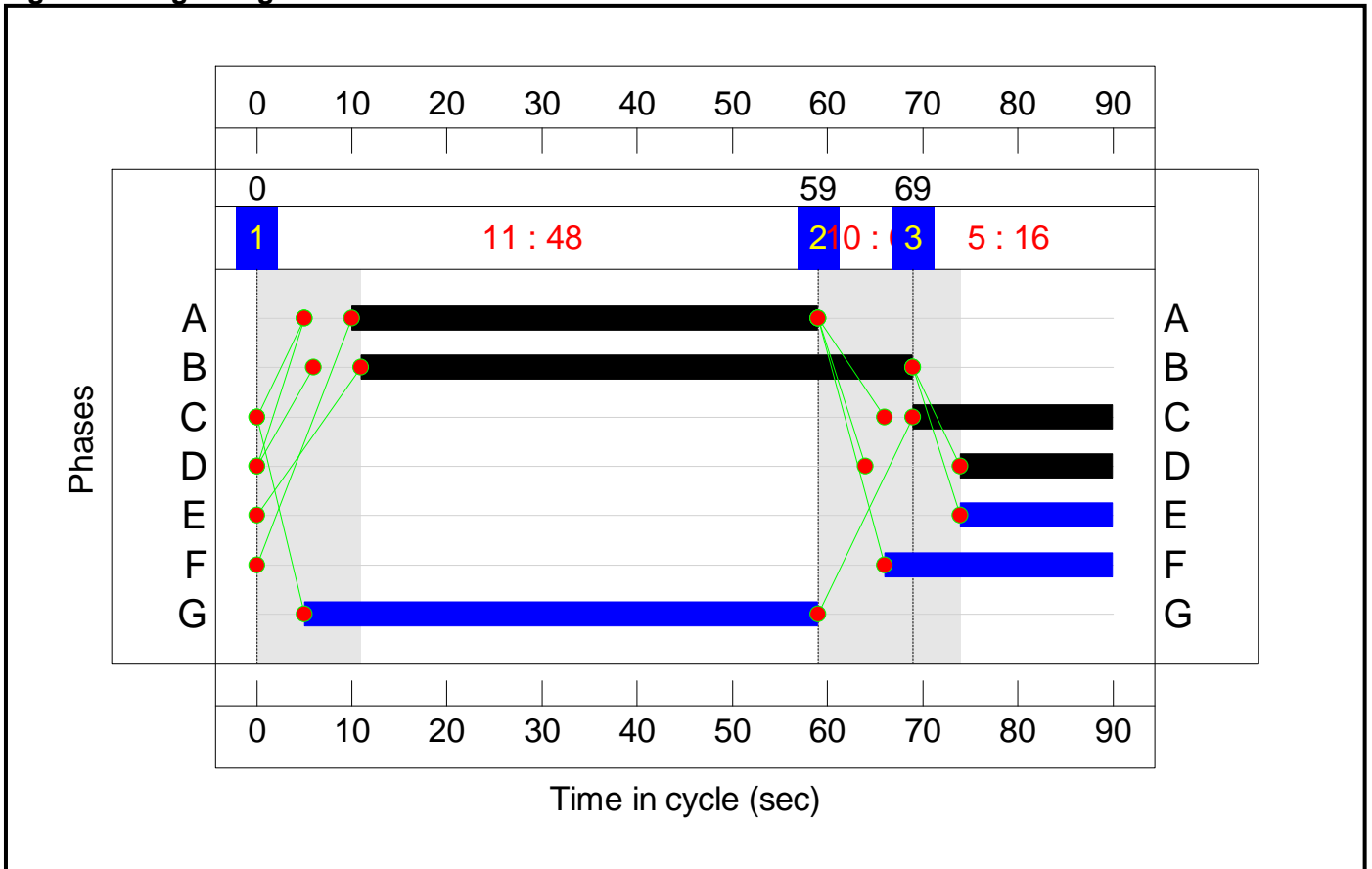

Full Input Data And Results
Network Layout Diagram

Full Input Data And Results

A414 N Orbital Rd_High Street Signalised Junction

PRC: -3.3 %
 Total Traffic Delay: 33.6 pcuHr
 Ave. Route Delay Per Ped: 0.0 s/Ped

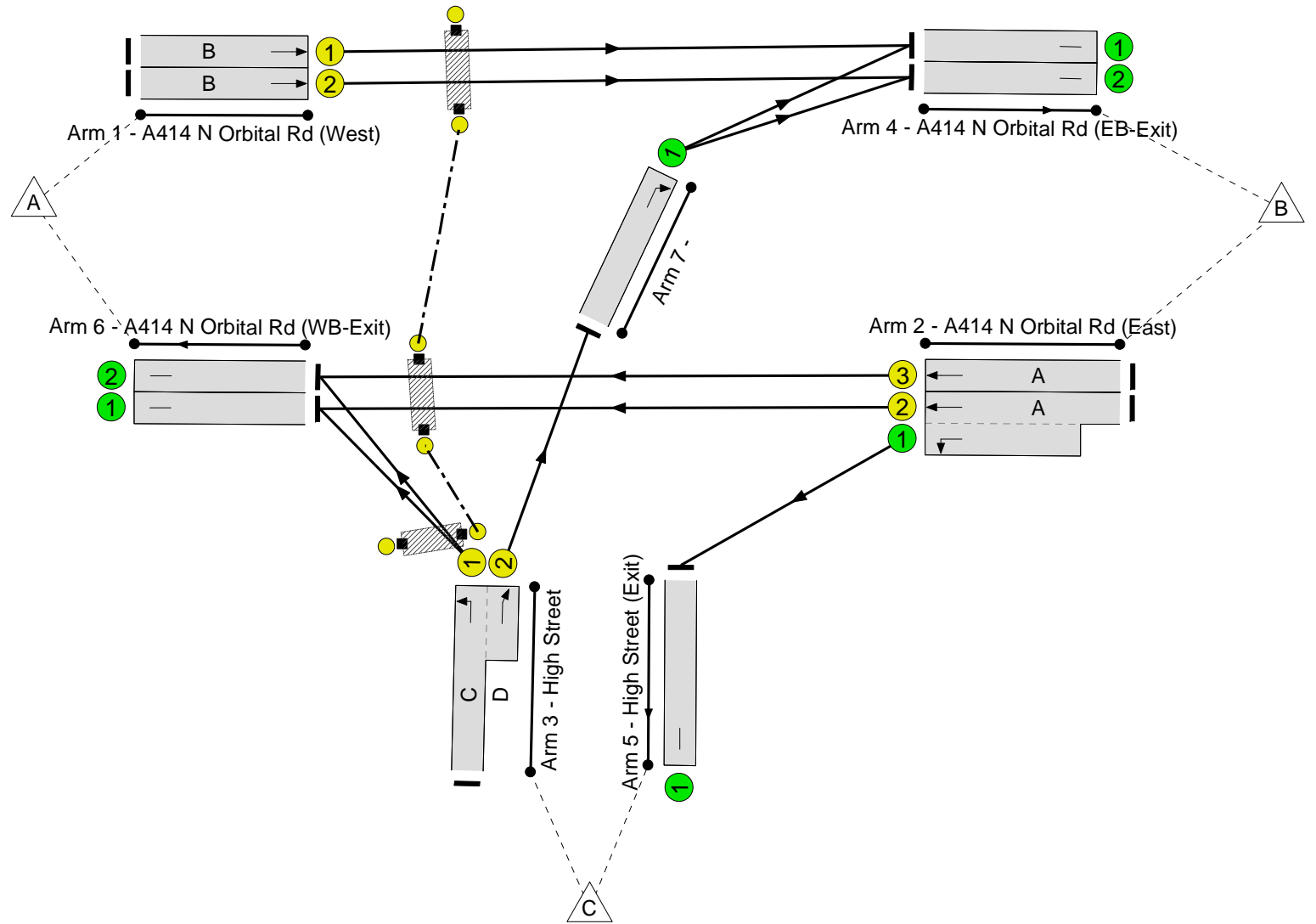
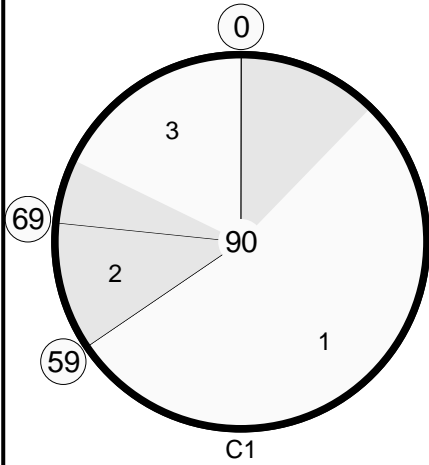

Full Input Data And Results

Full Input Data And Results

Network Results

Full Input Data And Results

Item	Lane Description	Lane Type	Controller Stream	Position In Filtered Route	Full Phase	Arrow Phase	Num Greens	Total Green (s)	Arrow Green (s)	Demand Flow (pcu)	Sat Flow (pcu/Hr)	Capacity (pcu)	Deg Sat (%)
Network: A414 N Orbital Rd_High Street Signalised Junction	-	-	N/A	-	-		-	-	-	-	-	-	93.0%
A414 N Orbital Rd_High Street Signalised Junction	-	-	N/A	-	-		-	-	-	-	-	-	93.0%
1/1	A414 N Orbital Rd (West) Ahead	U	N/A	N/A	B		1	58	-	790	1980	1298	60.9%
1/2	A414 N Orbital Rd (West) Ahead	U	N/A	N/A	B		1	58	-	789	1980	1298	60.8%
2/2+2/1	A414 N Orbital Rd (East) Left Ahead	U	N/A	N/A	A -		1	49	-	1280	2105:1965	984+393	93.0 : 93.0%
2/3	A414 N Orbital Rd (East) Ahead	U	N/A	N/A	A		1	49	-	979	1965	1092	89.7%
3/1+3/2	High Street Left Ahead	U	N/A	N/A	C D		1	21:16	-	436	1965:2015	159+310	92.9 : 92.9%
4/1	A414 N Orbital Rd (EB-Exit)	U	N/A	N/A	-		-	-	-	1078	Inf	Inf	0.0%
4/2	A414 N Orbital Rd (EB-Exit)	U	N/A	N/A	-		-	-	-	789	Inf	Inf	0.0%
5/1	High Street (Exit)	U	N/A	N/A	-		-	-	-	365	Inf	Inf	0.0%
6/1	A414 N Orbital Rd (WB-Exit)	U	N/A	N/A	-		-	-	-	989	Inf	Inf	0.0%
6/2	A414 N Orbital Rd (WB-Exit)	U	N/A	N/A	-		-	-	-	1053	Inf	Inf	0.0%
7/1	Right	U	N/A	N/A	-		-	-	-	288	2035	2035	14.2%
Ped Link: P1	Unnamed Ped Link	-	N/A	-	G		1	54	-	0	-	0	0.0%
Ped Link: P2	Unnamed Ped Link	-	N/A	-	F		1	24	-	0	-	0	0.0%
Ped Link: P3	Unnamed Ped Link	-	N/A	-	E		1	16	-	0	-	0	0.0%

Full Input Data And Results

Item	Arriving (pcu)	Leaving (pcu)	Turners In Gaps (pcu)	Turners When Unopposed (pcu)	Turners In Intergreen (pcu)	Uniform Delay (pcuHr)	Rand + Oversat Delay (pcuHr)	Storage Area Uniform Delay (pcuHr)	Total Delay (pcuHr)	Av. Delay Per PCU (s/pcu)	Max. Back of Uniform Queue (pcu)	Rand + Oversat Queue (pcu)	Mean Max Queue (pcu)
Network: A414 N Orbital Rd_High Street Signalised Junction	-	-	0	0	0	17.1	16.6	0.0	33.6	-	-	-	-
A414 N Orbital Rd_High Street Signalised Junction	-	-	0	0	0	17.1	16.6	0.0	33.6	-	-	-	-
1/1	790	790	-	-	-	1.9	0.8	-	2.7	12.4	11.2	0.8	12.0
1/2	789	789	-	-	-	1.9	0.8	-	2.7	12.4	11.2	0.8	12.0
2/2+2/1	1280	1280	-	-	-	4.3	5.9	-	10.1	28.5	22.8	5.9	28.7
2/3	979	979	-	-	-	4.8	4.1	-	8.9	32.6	21.5	4.1	25.5
3/1+3/2	436	436	-	-	-	4.1	5.0	-	9.1	75.2	8.9	5.0	13.9
4/1	1078	1078	-	-	-	0.0	0.0	-	0.0	0.0	0.0	0.0	0.0
4/2	789	789	-	-	-	0.0	0.0	-	0.0	0.0	0.0	0.0	0.0
5/1	365	365	-	-	-	0.0	0.0	-	0.0	0.0	0.0	0.0	0.0
6/1	989	989	-	-	-	0.0	0.0	-	0.0	0.0	0.0	0.0	0.0
6/2	1053	1053	-	-	-	0.0	0.0	-	0.0	0.0	0.0	0.0	0.0
7/1	288	288	-	-	-	0.0	0.1	-	0.1	1.0	0.0	0.1	0.1
Ped Link: P1	0	0	-	-	-	-	-	-	-	-	-	-	-
Ped Link: P2	0	0	-	-	-	-	-	-	-	-	-	-	-
Ped Link: P3	0	0	-	-	-	-	-	-	-	-	-	-	-
C1			PRC for Signalled Lanes (%):		-3.3	Total Delay for Signalled Lanes (pcuHr):		33.56	Cycle Time (s): 90				
			PRC Over All Lanes (%):		-3.3	Total Delay Over All Lanes(pcuHr):		33.65					

Full Input Data And Results

Scenario 3: '2027 Base AM Peak' (FG3: '2027 Base AM Peak', Plan 1: 'Network Control Plan 1')

Stage Sequence Diagram

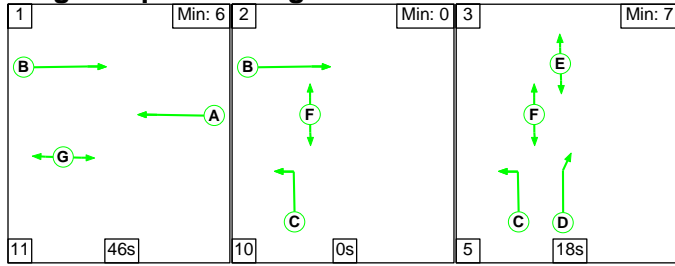

Stage Timings

Stage	1	2	3
Duration	46	0	18
Change Point	0	57	67

Signal Timings Diagram

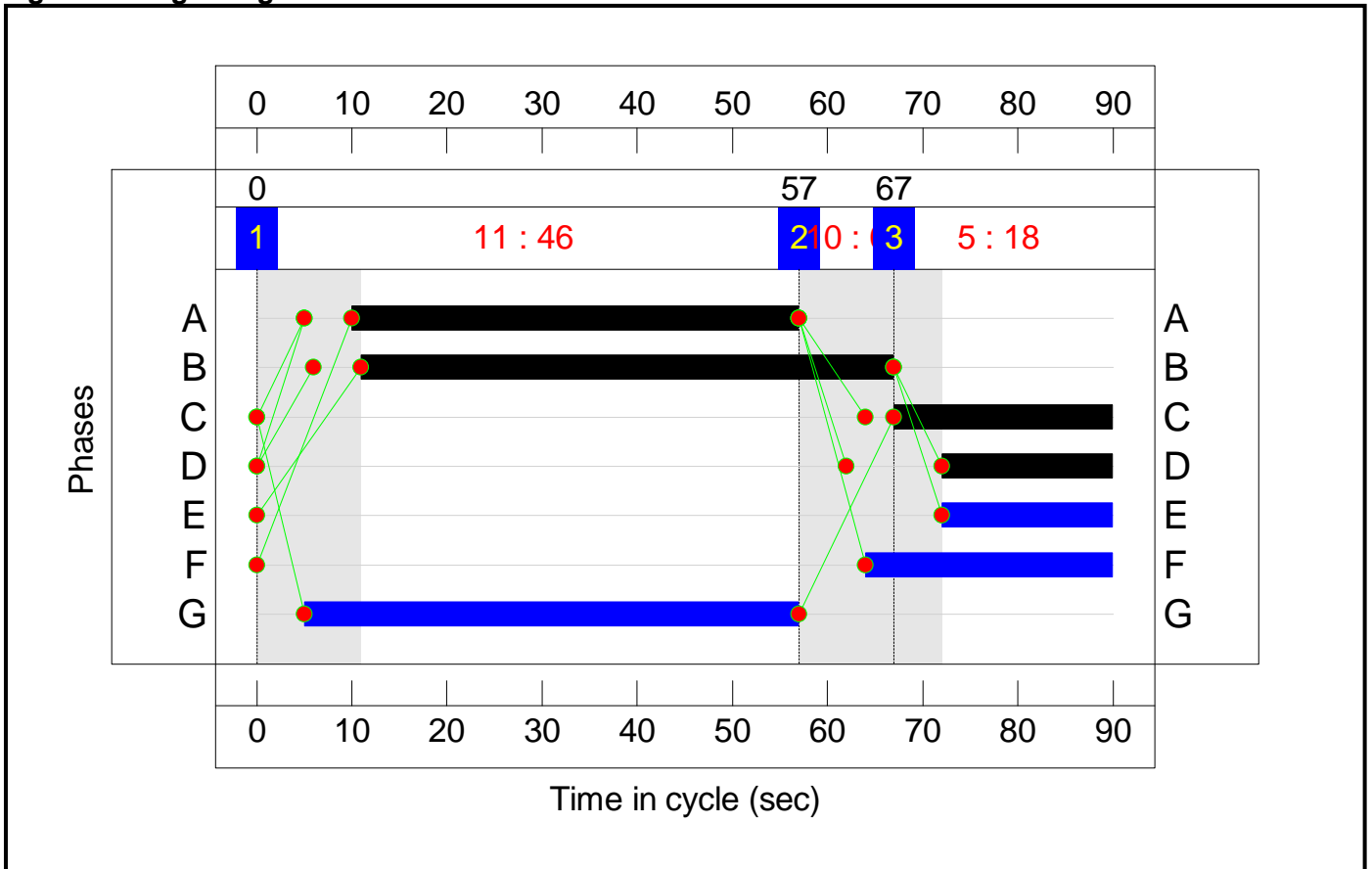

Full Input Data And Results
Network Layout Diagram

Full Input Data And Results

A414 N Orbital Rd_High Street Signalised Junction

PRC: -5.0 %
 Total Traffic Delay: 38.7 pcuHr
 Ave. Route Delay Per Ped: 0.0 s/Ped

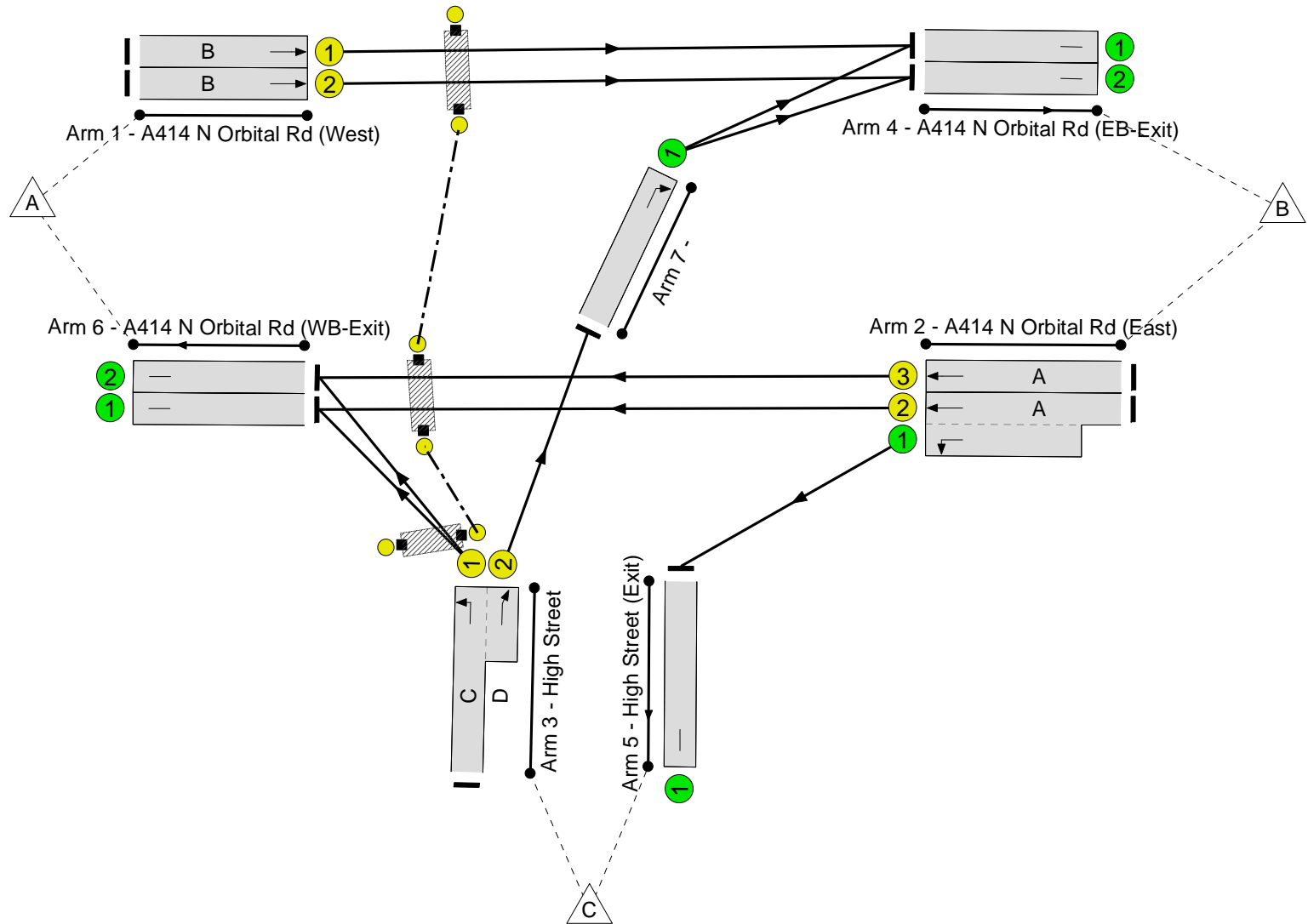
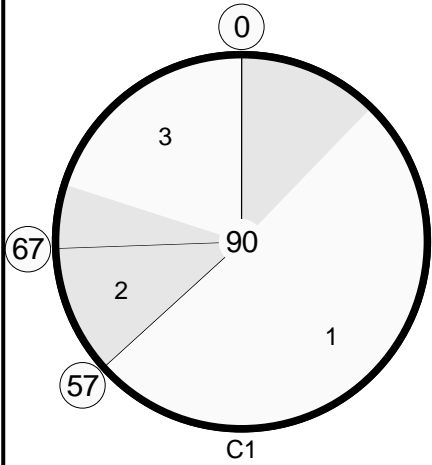

Full Input Data And Results

Full Input Data And Results

Network Results

Full Input Data And Results

Item	Lane Description	Lane Type	Controller Stream	Position In Filtered Route	Full Phase	Arrow Phase	Num Greens	Total Green (s)	Arrow Green (s)	Demand Flow (pcu)	Sat Flow (pcu/Hr)	Capacity (pcu)	Deg Sat (%)
Network: A414 N Orbital Rd_High Street Signalised Junction	-	-	N/A	-	-		-	-	-	-	-	-	94.5%
A414 N Orbital Rd_High Street Signalised Junction	-	-	N/A	-	-		-	-	-	-	-	-	94.5%
1/1	A414 N Orbital Rd (West) Ahead	U	N/A	N/A	B		1	56	-	854	1980	1254	68.1%
1/2	A414 N Orbital Rd (West) Ahead	U	N/A	N/A	B		1	56	-	853	1980	1254	68.0%
2/2+2/1	A414 N Orbital Rd (East) Left Ahead	U	N/A	N/A	A -		1	47	-	1271	2105:1965	943+402	94.5 : 94.5%
2/3	A414 N Orbital Rd (East) Ahead	U	N/A	N/A	A		1	47	-	962	1965	1048	91.8%
3/1+3/2	High Street Left Ahead	U	N/A	N/A	C D		1	23:18	-	536	1965:2015	288+292	92.4 : 92.4%
4/1	A414 N Orbital Rd (EB-Exit)	U	N/A	N/A	-		-	-	-	1124	Inf	Inf	0.0%
4/2	A414 N Orbital Rd (EB-Exit)	U	N/A	N/A	-		-	-	-	853	Inf	Inf	0.0%
5/1	High Street (Exit)	U	N/A	N/A	-		-	-	-	380	Inf	Inf	0.0%
6/1	A414 N Orbital Rd (WB-Exit)	U	N/A	N/A	-		-	-	-	1024	Inf	Inf	0.0%
6/2	A414 N Orbital Rd (WB-Exit)	U	N/A	N/A	-		-	-	-	1095	Inf	Inf	0.0%
7/1	Right	U	N/A	N/A	-		-	-	-	270	2035	2035	13.3%
Ped Link: P1	Unnamed Ped Link	-	N/A	-	G		1	52	-	0	-	0	0.0%
Ped Link: P2	Unnamed Ped Link	-	N/A	-	F		1	26	-	0	-	0	0.0%
Ped Link: P3	Unnamed Ped Link	-	N/A	-	E		1	18	-	0	-	0	0.0%

Full Input Data And Results

Item	Arriving (pcu)	Leaving (pcu)	Turners In Gaps (pcu)	Turners When Unopposed (pcu)	Turners In Intergreen (pcu)	Uniform Delay (pcuHr)	Rand + Oversat Delay (pcuHr)	Storage Area Uniform Delay (pcuHr)	Total Delay (pcuHr)	Av. Delay Per PCU (s/pcu)	Max. Back of Uniform Queue (pcu)	Rand + Oversat Queue (pcu)	Mean Max Queue (pcu)
Network: A414 N Orbital Rd_High Street Signalised Junction	-	-	0	0	0	19.4	19.3	0.0	38.7	-	-	-	-
A414 N Orbital Rd_High Street Signalised Junction	-	-	0	0	0	19.4	19.3	0.0	38.7	-	-	-	-
1/1	854	854	-	-	-	2.5	1.1	-	3.6	15.1	13.8	1.1	14.8
1/2	853	853	-	-	-	2.5	1.1	-	3.6	15.1	13.5	1.1	14.6
2/2+2/1	1271	1271	-	-	-	4.5	7.2	-	11.7	33.1	23.1	7.2	30.3
2/3	962	962	-	-	-	5.1	5.0	-	10.1	37.9	21.9	5.0	26.9
3/1+3/2	536	536	-	-	-	4.7	5.0	-	9.7	65.1	9.5	5.0	14.5
4/1	1124	1124	-	-	-	0.0	0.0	-	0.0	0.0	0.0	0.0	0.0
4/2	853	853	-	-	-	0.0	0.0	-	0.0	0.0	0.0	0.0	0.0
5/1	380	380	-	-	-	0.0	0.0	-	0.0	0.0	0.0	0.0	0.0
6/1	1024	1024	-	-	-	0.0	0.0	-	0.0	0.0	0.0	0.0	0.0
6/2	1095	1095	-	-	-	0.0	0.0	-	0.0	0.0	0.0	0.0	0.0
7/1	270	270	-	-	-	0.0	0.1	-	0.1	1.0	0.0	0.1	0.1
Ped Link: P1	0	0	-	-	-	-	-	-	-	-	-	-	-
Ped Link: P2	0	0	-	-	-	-	-	-	-	-	-	-	-
Ped Link: P3	0	0	-	-	-	-	-	-	-	-	-	-	-
C1			PRC for Signalled Lanes (%):		-5.0	Total Delay for Signalled Lanes (pcuHr):		38.67	Cycle Time (s): 90				
			PRC Over All Lanes (%):		-5.0	Total Delay Over All Lanes(pcuHr):		38.75					

Full Input Data And Results

Scenario 4: '2027 Base PM Peak' (FG4: '2027 Base PM Peak', Plan 1: 'Network Control Plan 1')

Stage Sequence Diagram

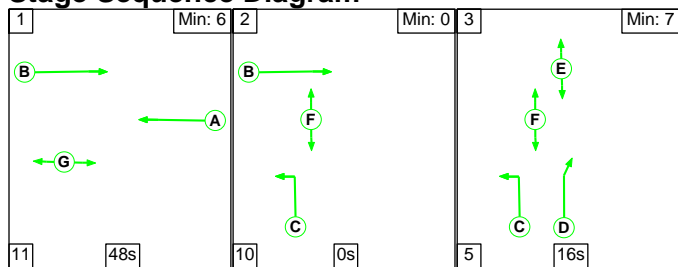

Stage Timings

Stage	1	2	3
Duration	48	0	16
Change Point	0	59	69

Signal Timings Diagram

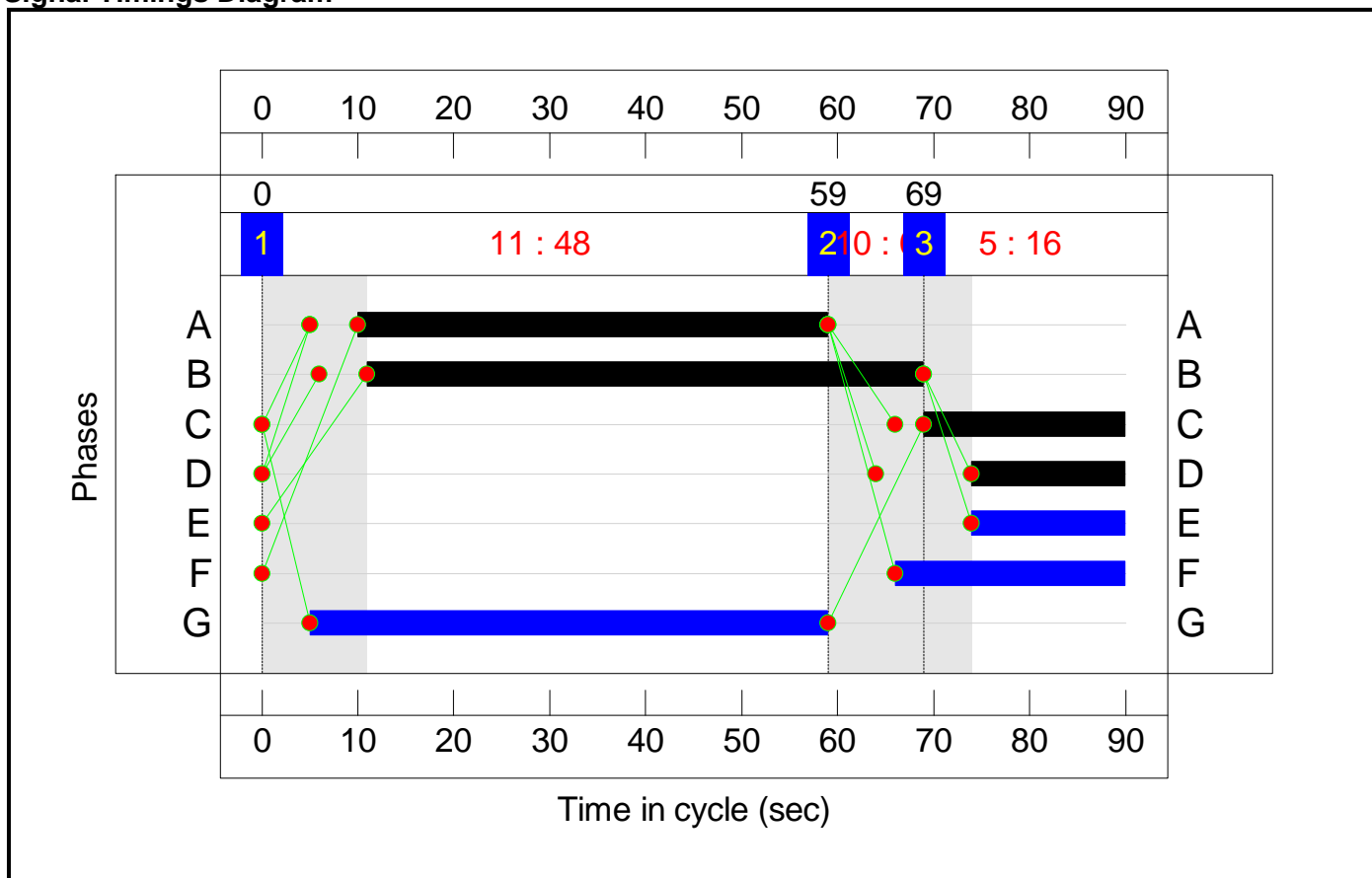

Full Input Data And Results
Network Layout Diagram

Full Input Data And Results

A414 N Orbital Rd_High Street Signalised Junction

PRC: -4.9 %
 Total Traffic Delay: 36.8 pcuHr
 Ave. Route Delay Per Ped: 0.0 s/Ped

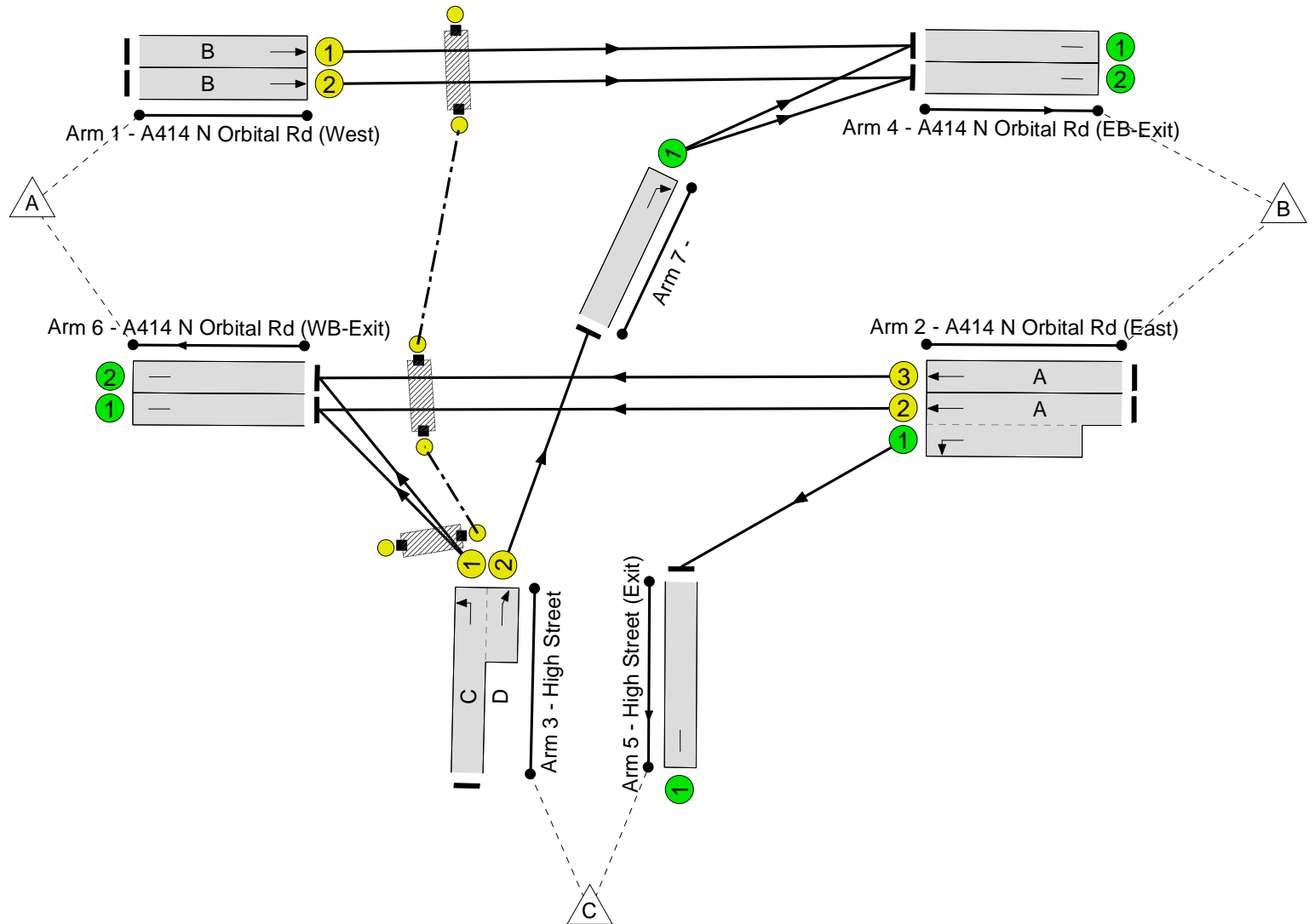
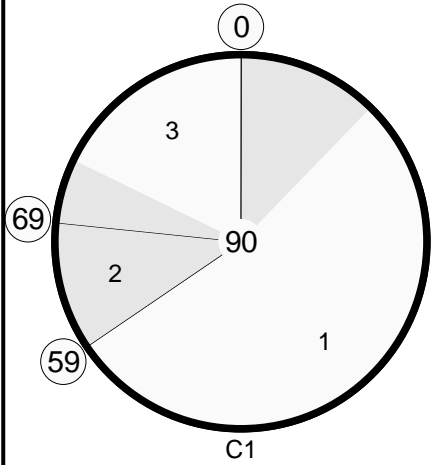

Full Input Data And Results

Full Input Data And Results

Network Results

Full Input Data And Results

Item	Lane Description	Lane Type	Controller Stream	Position In Filtered Route	Full Phase	Arrow Phase	Num Greens	Total Green (s)	Arrow Green (s)	Demand Flow (pcu)	Sat Flow (pcu/Hr)	Capacity (pcu)	Deg Sat (%)
Network: A414 N Orbital Rd_High Street Signalised Junction	-	-	N/A	-	-		-	-	-	-	-	-	94.4%
A414 N Orbital Rd_High Street Signalised Junction	-	-	N/A	-	-		-	-	-	-	-	-	94.4%
1/1	A414 N Orbital Rd (West) Ahead	U	N/A	N/A	B		1	58	-	802	1980	1298	61.8%
1/2	A414 N Orbital Rd (West) Ahead	U	N/A	N/A	B		1	58	-	802	1980	1298	61.8%
2/2+2/1	A414 N Orbital Rd (East) Left Ahead	U	N/A	N/A	A -		1	49	-	1297	2105:1965	984+394	94.1 : 94.1%
2/3	A414 N Orbital Rd (East) Ahead	U	N/A	N/A	A		1	49	-	998	1965	1092	91.4%
3/1+3/2	High Street Left Ahead	U	N/A	N/A	C D		1	21:16	-	443	1965:2015	159+310	94.4 : 94.4%
4/1	A414 N Orbital Rd (EB-Exit)	U	N/A	N/A	-		-	-	-	1095	Inf	Inf	0.0%
4/2	A414 N Orbital Rd (EB-Exit)	U	N/A	N/A	-		-	-	-	802	Inf	Inf	0.0%
5/1	High Street (Exit)	U	N/A	N/A	-		-	-	-	371	Inf	Inf	0.0%
6/1	A414 N Orbital Rd (WB-Exit)	U	N/A	N/A	-		-	-	-	1001	Inf	Inf	0.0%
6/2	A414 N Orbital Rd (WB-Exit)	U	N/A	N/A	-		-	-	-	1073	Inf	Inf	0.0%
7/1	Right	U	N/A	N/A	-		-	-	-	293	2035	2035	14.4%
Ped Link: P1	Unnamed Ped Link	-	N/A	-	G		1	54	-	0	-	0	0.0%
Ped Link: P2	Unnamed Ped Link	-	N/A	-	F		1	24	-	0	-	0	0.0%
Ped Link: P3	Unnamed Ped Link	-	N/A	-	E		1	16	-	0	-	0	0.0%

Full Input Data And Results

Item	Arriving (pcu)	Leaving (pcu)	Turners In Gaps (pcu)	Turners When Unopposed (pcu)	Turners In Intergreen (pcu)	Uniform Delay (pcuHr)	Rand + Oversat Delay (pcuHr)	Storage Area Uniform Delay (pcuHr)	Total Delay (pcuHr)	Av. Delay Per PCU (s/pcu)	Max. Back of Uniform Queue (pcu)	Rand + Oversat Queue (pcu)	Mean Max Queue (pcu)
Network: A414 N Orbital Rd_High Street Signalised Junction	-	-	0	0	0	17.6	19.2	0.0	36.8	-	-	-	-
A414 N Orbital Rd_High Street Signalised Junction	-	-	0	0	0	17.6	19.2	0.0	36.8	-	-	-	-
1/1	802	802	-	-	-	2.0	0.8	-	2.8	12.6	11.6	0.8	12.4
1/2	802	802	-	-	-	2.0	0.8	-	2.8	12.6	11.6	0.8	12.4
2/2+2/1	1297	1297	-	-	-	4.4	6.9	-	11.2	31.2	23.6	6.9	30.5
2/3	998	998	-	-	-	5.0	4.8	-	9.8	35.5	22.5	4.8	27.3
3/1+3/2	443	443	-	-	-	4.2	5.8	-	10.0	81.5	9.0	5.8	14.9
4/1	1095	1095	-	-	-	0.0	0.0	-	0.0	0.0	0.0	0.0	0.0
4/2	802	802	-	-	-	0.0	0.0	-	0.0	0.0	0.0	0.0	0.0
5/1	371	371	-	-	-	0.0	0.0	-	0.0	0.0	0.0	0.0	0.0
6/1	1001	1001	-	-	-	0.0	0.0	-	0.0	0.0	0.0	0.0	0.0
6/2	1073	1073	-	-	-	0.0	0.0	-	0.0	0.0	0.0	0.0	0.0
7/1	293	293	-	-	-	0.0	0.1	-	0.1	1.0	0.0	0.1	0.1
Ped Link: P1	0	0	-	-	-	-	-	-	-	-	-	-	-
Ped Link: P2	0	0	-	-	-	-	-	-	-	-	-	-	-
Ped Link: P3	0	0	-	-	-	-	-	-	-	-	-	-	-
C1		PRC for Signalled Lanes (%):		-4.9		Total Delay for Signalled Lanes (pcuHr):		36.72		Cycle Time (s): 90			
		PRC Over All Lanes (%):		-4.9		Total Delay Over All Lanes(pcuHr):		36.80					

Full Input Data And Results

Scenario 5: '2027 Base + Dev AM Peak' (FG5: '2027 Base + Dev AM Peak', Plan 1: 'Network Control Plan 1')

Stage Sequence Diagram

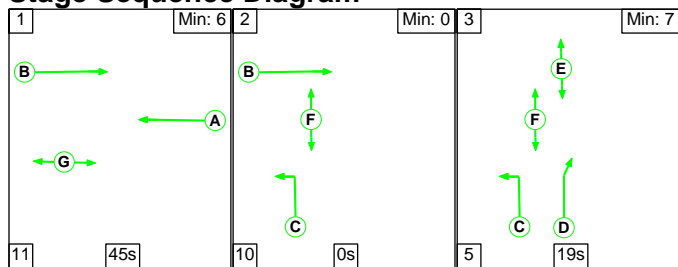

Stage Timings

Stage	1	2	3
Duration	45	0	19
Change Point	0	56	66

Signal Timings Diagram

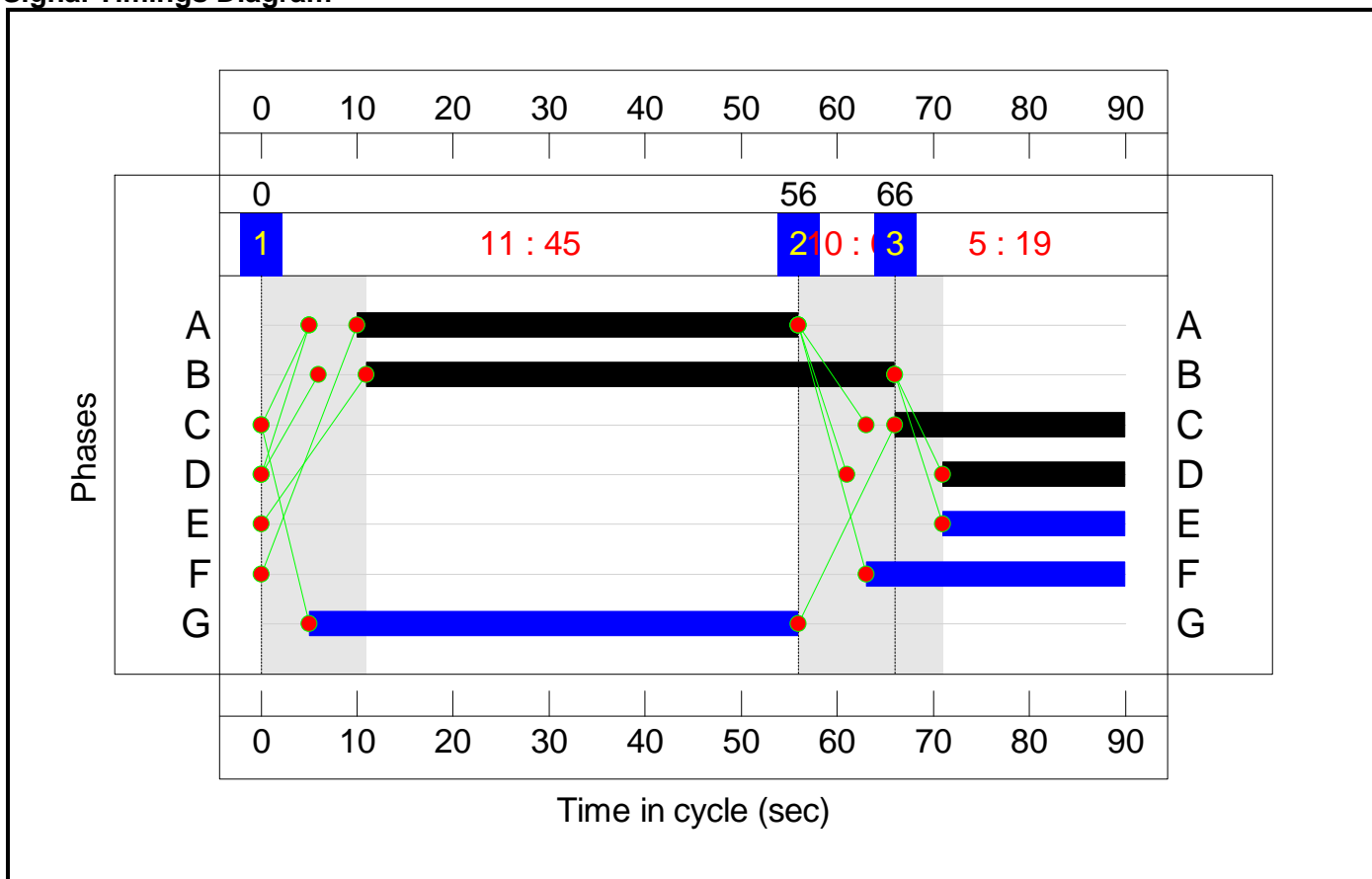

Full Input Data And Results
Network Layout Diagram

Full Input Data And Results

A414 N Orbital Rd_High Street Signalised Junction

PRC: -7.0 %
 Total Traffic Delay: 43.9 pcuHr
 Ave. Route Delay Per Ped: 0.0 s/Ped

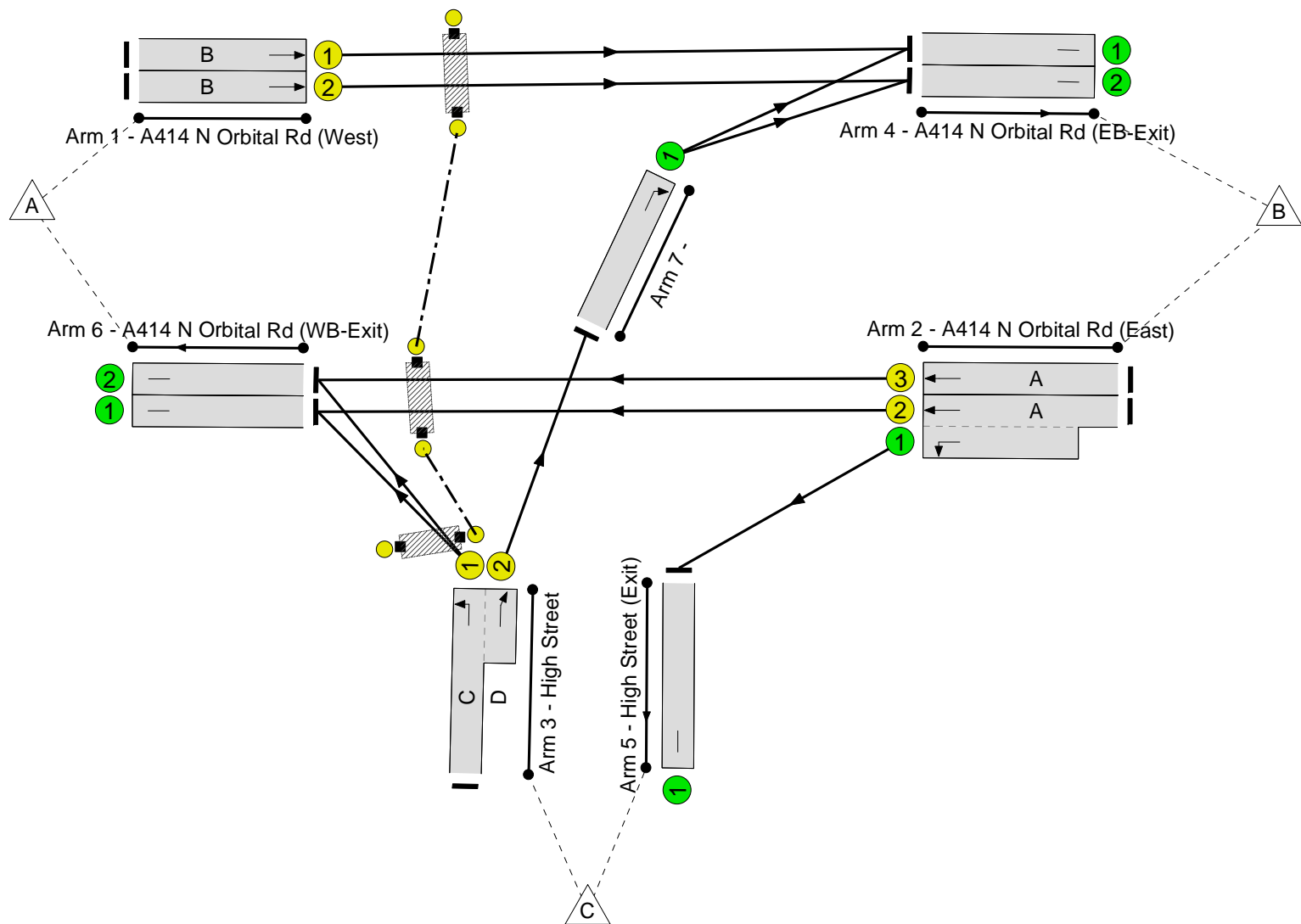
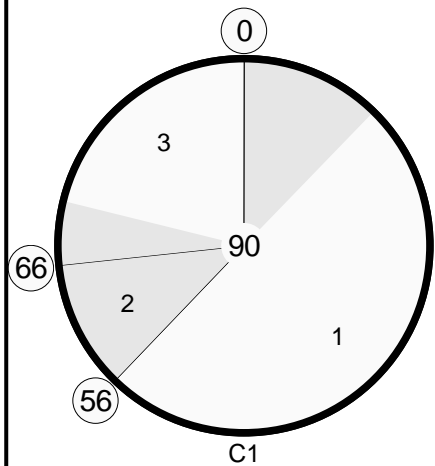

Full Input Data And Results

Full Input Data And Results

Network Results

Full Input Data And Results

Item	Lane Description	Lane Type	Controller Stream	Position In Filtered Route	Full Phase	Arrow Phase	Num Greens	Total Green (s)	Arrow Green (s)	Demand Flow (pcu)	Sat Flow (pcu/Hr)	Capacity (pcu)	Deg Sat (%)
Network: A414 N Orbital Rd_High Street Signalised Junction	-	-	N/A	-	-		-	-	-	-	-	-	96.3%
A414 N Orbital Rd_High Street Signalised Junction	-	-	N/A	-	-		-	-	-	-	-	-	96.3%
1/1	A414 N Orbital Rd (West) Ahead	U	N/A	N/A	B		1	55	-	854	1980	1232	69.3%
1/2	A414 N Orbital Rd (West) Ahead	U	N/A	N/A	B		1	55	-	853	1980	1232	69.2%
2/2+2/1	A414 N Orbital Rd (East) Left Ahead	U	N/A	N/A	A -		1	46	-	1278	2105:1965	924+403	96.3 : 96.3%
2/3	A414 N Orbital Rd (East) Ahead	U	N/A	N/A	A		1	46	-	963	1965	1026	93.8%
3/1+3/2	High Street Left Ahead	U	N/A	N/A	C D		1	24:19	-	554	1965:2015	285+309	93.3 : 93.3%
4/1	A414 N Orbital Rd (EB-Exit)	U	N/A	N/A	-		-	-	-	1142	Inf	Inf	0.0%
4/2	A414 N Orbital Rd (EB-Exit)	U	N/A	N/A	-		-	-	-	853	Inf	Inf	0.0%
5/1	High Street (Exit)	U	N/A	N/A	-		-	-	-	388	Inf	Inf	0.0%
6/1	A414 N Orbital Rd (WB-Exit)	U	N/A	N/A	-		-	-	-	1023	Inf	Inf	0.0%
6/2	A414 N Orbital Rd (WB-Exit)	U	N/A	N/A	-		-	-	-	1096	Inf	Inf	0.0%
7/1	Right	U	N/A	N/A	-		-	-	-	288	2035	2035	14.2%
Ped Link: P1	Unnamed Ped Link	-	N/A	-	G		1	51	-	0	-	0	0.0%
Ped Link: P2	Unnamed Ped Link	-	N/A	-	F		1	27	-	0	-	0	0.0%
Ped Link: P3	Unnamed Ped Link	-	N/A	-	E		1	19	-	0	-	0	0.0%

Full Input Data And Results

Item	Arriving (pcu)	Leaving (pcu)	Turners In Gaps (pcu)	Turners When Unopposed (pcu)	Turners In Intergreen (pcu)	Uniform Delay (pcuHr)	Rand + Oversat Delay (pcuHr)	Storage Area Uniform Delay (pcuHr)	Total Delay (pcuHr)	Av. Delay Per PCU (s/pcu)	Max. Back of Uniform Queue (pcu)	Rand + Oversat Queue (pcu)	Mean Max Queue (pcu)
Network: A414 N Orbital Rd_High Street Signalised Junction	-	-	0	0	0	20.3	23.6	0.0	43.9	-	-	-	-
A414 N Orbital Rd_High Street Signalised Junction	-	-	0	0	0	20.3	23.6	0.0	43.9	-	-	-	-
1/1	854	854	-	-	-	2.7	1.1	-	3.8	16.0	14.0	1.1	15.1
1/2	853	853	-	-	-	2.7	1.1	-	3.8	16.0	14.0	1.1	15.1
2/2+2/1	1278	1278	-	-	-	4.8	9.4	-	14.2	39.9	24.2	9.4	33.6
2/3	963	963	-	-	-	5.4	6.3	-	11.7	43.9	22.5	6.3	28.8
3/1+3/2	554	554	-	-	-	4.8	5.5	-	10.3	67.0	10.2	5.5	15.6
4/1	1142	1142	-	-	-	0.0	0.0	-	0.0	0.0	0.0	0.0	0.0
4/2	853	853	-	-	-	0.0	0.0	-	0.0	0.0	0.0	0.0	0.0
5/1	388	388	-	-	-	0.0	0.0	-	0.0	0.0	0.0	0.0	0.0
6/1	1023	1023	-	-	-	0.0	0.0	-	0.0	0.0	0.0	0.0	0.0
6/2	1096	1096	-	-	-	0.0	0.0	-	0.0	0.0	0.0	0.0	0.0
7/1	288	288	-	-	-	0.0	0.1	-	0.1	1.0	0.0	0.1	0.1
Ped Link: P1	0	0	-	-	-	-	-	-	-	-	-	-	-
Ped Link: P2	0	0	-	-	-	-	-	-	-	-	-	-	-
Ped Link: P3	0	0	-	-	-	-	-	-	-	-	-	-	-
C1		PRC for Signalled Lanes (%): -7.0			Total Delay for Signalled Lanes (pcuHr): 43.81			Cycle Time (s): 90					
		PRC Over All Lanes (%): -7.0			Total Delay Over All Lanes(pcuHr): 43.89								

Full Input Data And Results

Scenario 6: '2027 Base + Dev PM Peak' (FG6: '2027 Base + Dev PM Peak', Plan 1: 'Network Control Plan 1')

Stage Sequence Diagram

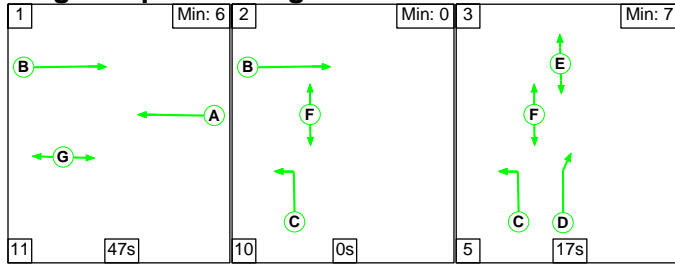

Stage Timings

Stage	1	2	3
Duration	47	0	17
Change Point	0	58	68

Signal Timings Diagram

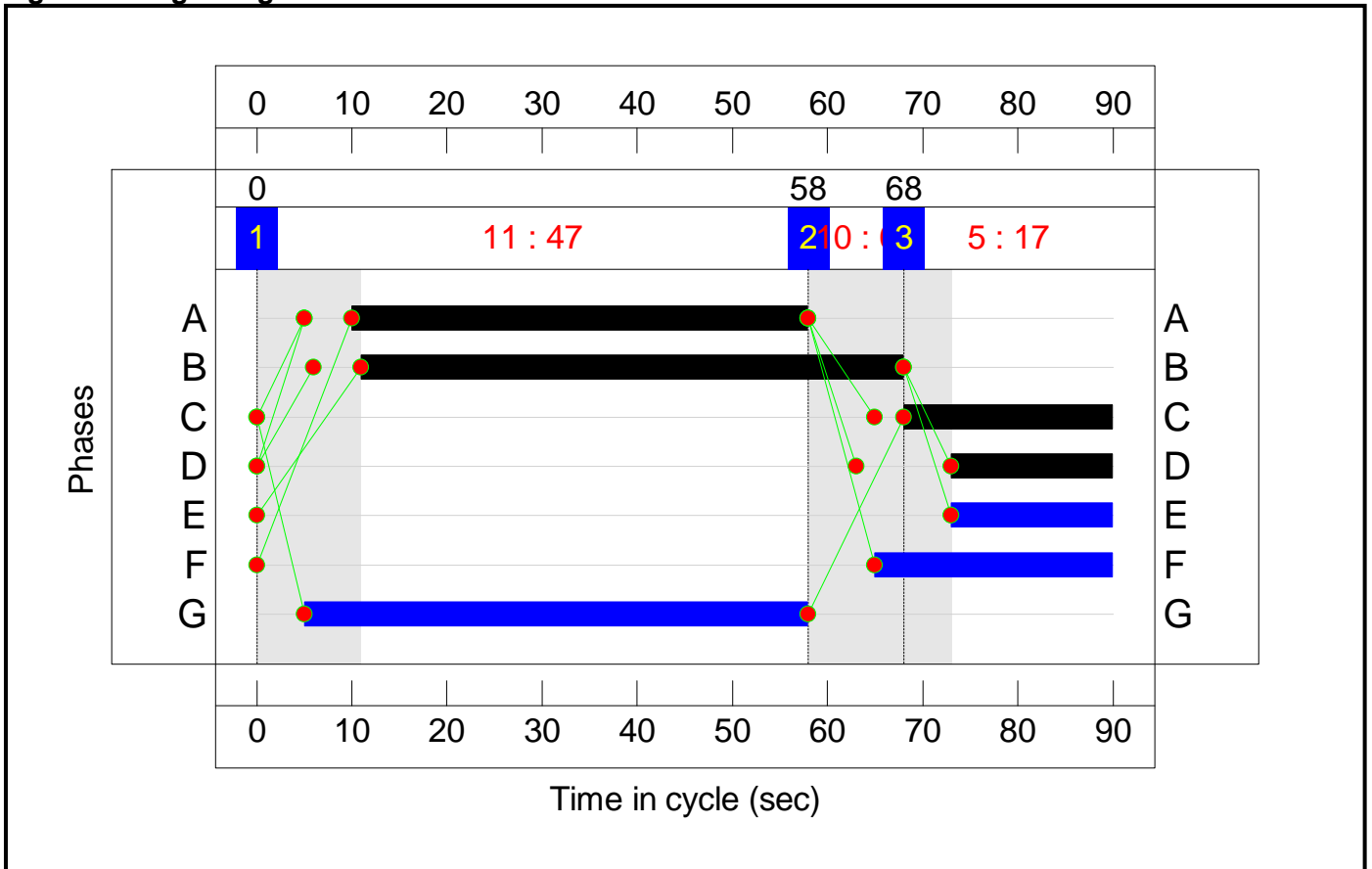

Full Input Data And Results
Network Layout Diagram

Full Input Data And Results

A414 N Orbital Rd_High Street Signalised Junction

PRC: -6.5 %
 Total Traffic Delay: 40.2 pcuHr
 Ave. Route Delay Per Ped: 0.0 s/Ped

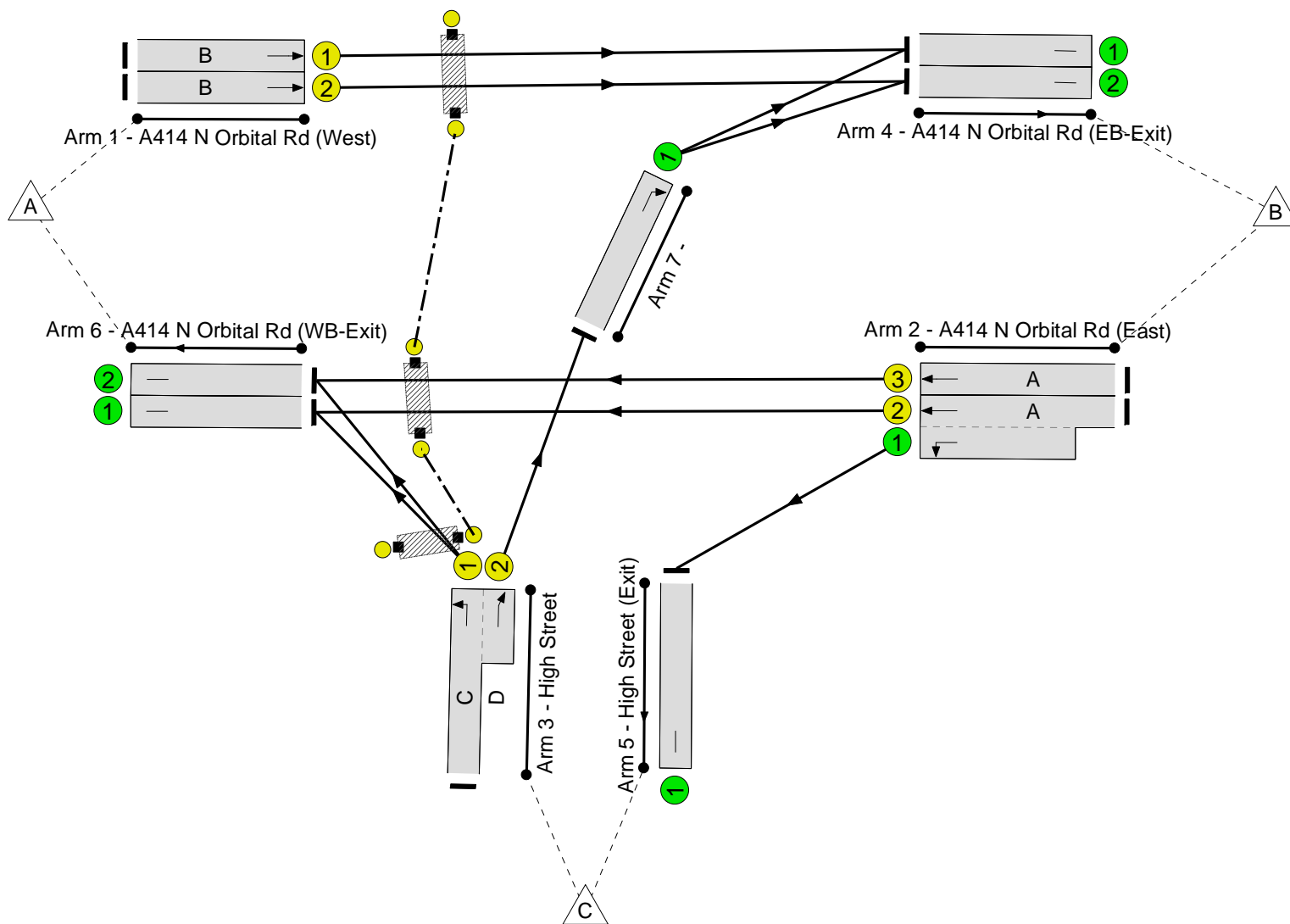
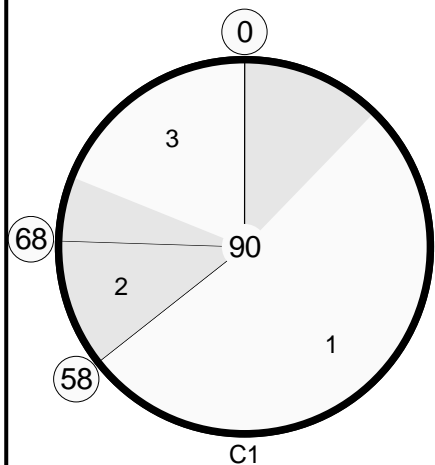

Full Input Data And Results

Full Input Data And Results

Network Results

Full Input Data And Results

Item	Lane Description	Lane Type	Controller Stream	Position In Filtered Route	Full Phase	Arrow Phase	Num Greens	Total Green (s)	Arrow Green (s)	Demand Flow (pcu)	Sat Flow (pcu/Hr)	Capacity (pcu)	Deg Sat (%)
Network: A414 N Orbital Rd_High Street Signalised Junction	-	-	N/A	-	-		-	-	-	-	-	-	95.9%
A414 N Orbital Rd_High Street Signalised Junction	-	-	N/A	-	-		-	-	-	-	-	-	95.9%
1/1	A414 N Orbital Rd (West) Ahead	U	N/A	N/A	B		1	57	-	802	1980	1276	62.9%
1/2	A414 N Orbital Rd (West) Ahead	U	N/A	N/A	B		1	57	-	802	1980	1276	62.9%
2/2+2/1	A414 N Orbital Rd (East) Left Ahead	U	N/A	N/A	A -		1	48	-	1309	2105:1965	961+405	95.9 : 95.9%
2/3	A414 N Orbital Rd (East) Ahead	U	N/A	N/A	A		1	48	-	1003	1965	1070	93.8%
3/1+3/2	High Street Left Ahead	U	N/A	N/A	C D		1	22:17	-	453	1965:2015	162+327	92.6 : 92.6%
4/1	A414 N Orbital Rd (EB-Exit)	U	N/A	N/A	-		-	-	-	1105	Inf	Inf	0.0%
4/2	A414 N Orbital Rd (EB-Exit)	U	N/A	N/A	-		-	-	-	802	Inf	Inf	0.0%
5/1	High Street (Exit)	U	N/A	N/A	-		-	-	-	388	Inf	Inf	0.0%
6/1	A414 N Orbital Rd (WB-Exit)	U	N/A	N/A	-		-	-	-	996	Inf	Inf	0.0%
6/2	A414 N Orbital Rd (WB-Exit)	U	N/A	N/A	-		-	-	-	1078	Inf	Inf	0.0%
7/1	Right	U	N/A	N/A	-		-	-	-	303	2035	2035	14.9%
Ped Link: P1	Unnamed Ped Link	-	N/A	-	G		1	53	-	0	-	0	0.0%
Ped Link: P2	Unnamed Ped Link	-	N/A	-	F		1	25	-	0	-	0	0.0%
Ped Link: P3	Unnamed Ped Link	-	N/A	-	E		1	17	-	0	-	0	0.0%

Full Input Data And Results

Item	Arriving (pcu)	Leaving (pcu)	Turners In Gaps (pcu)	Turners When Unopposed (pcu)	Turners In Intergreen (pcu)	Uniform Delay (pcuHr)	Rand + Oversat Delay (pcuHr)	Storage Area Uniform Delay (pcuHr)	Total Delay (pcuHr)	Av. Delay Per PCU (s/pcu)	Max. Back of Uniform Queue (pcu)	Rand + Oversat Queue (pcu)	Mean Max Queue (pcu)
Network: A414 N Orbital Rd_High Street Signalised Junction	-	-	0	0	0	18.4	21.8	0.0	40.2	-	-	-	-
A414 N Orbital Rd_High Street Signalised Junction	-	-	0	0	0	18.4	21.8	0.0	40.2	-	-	-	-
1/1	802	802	-	-	-	2.1	0.8	-	3.0	13.3	11.8	0.8	12.7
1/2	802	802	-	-	-	2.1	0.8	-	3.0	13.3	11.8	0.8	12.7
2/2+2/1	1309	1309	-	-	-	4.6	8.8	-	13.5	37.0	24.8	8.8	33.7
2/3	1003	1003	-	-	-	5.3	6.3	-	11.6	41.7	23.1	6.3	29.4
3/1+3/2	453	453	-	-	-	4.2	4.9	-	9.1	72.5	9.2	4.9	14.1
4/1	1105	1105	-	-	-	0.0	0.0	-	0.0	0.0	0.0	0.0	0.0
4/2	802	802	-	-	-	0.0	0.0	-	0.0	0.0	0.0	0.0	0.0
5/1	388	388	-	-	-	0.0	0.0	-	0.0	0.0	0.0	0.0	0.0
6/1	996	996	-	-	-	0.0	0.0	-	0.0	0.0	0.0	0.0	0.0
6/2	1078	1078	-	-	-	0.0	0.0	-	0.0	0.0	0.0	0.0	0.0
7/1	303	303	-	-	-	0.0	0.1	-	0.1	1.0	0.0	0.1	0.1
Ped Link: P1	0	0	-	-	-	-	-	-	-	-	-	-	-
Ped Link: P2	0	0	-	-	-	-	-	-	-	-	-	-	-
Ped Link: P3	0	0	-	-	-	-	-	-	-	-	-	-	-
C1			PRC for Signalled Lanes (%):		-6.5	Total Delay for Signalled Lanes (pcuHr):		40.15	Cycle Time (s):		90		
			PRC Over All Lanes (%):		-6.5	Total Delay Over All Lanes(pcuHr):		40.24					

Appendix 15 – Junctions 10 Outputs

Junctions 10
ARCADY 10 - Roundabout Module
Version: 10.0.3.1598 © Copyright TRL Software Limited, 2021
For sales and distribution information, program advice and maintenance, contact TRL Software: +44 (0)1344 379777 software@trl.co.uk trlsoftware.com
The users of this computer program for the solution of an engineering problem are in no way relieved of their responsibility for the correctness of the solution

Filename: Dixons Hill Road.Great North Road Roundabout.j10
Path: P:\JNY11289 - Colney Heath\Transport\Arcady
Report generation date: 27/04/2022 15:46:52

- »2022, AM
- »2022, PM
- »2027, AM
- »2027, PM
- »2027 + Dev, AM
- »2027 + Dev, PM

Summary of junction performance

	AM					PM				
	Set ID	Queue (Veh)	Delay (s)	RFC	LOS	Set ID	Queue (Veh)	Delay (s)	RFC	LOS
2022										
1 - Great North Road (S)	D1	1.5	6.30	0.60	A	D2	0.6	3.60	0.39	A
2 - Dixons Hill Road		1.0	6.62	0.50	A		2.0	9.72	0.67	A
3 - Great North Road (N)		4.1	13.95	0.81	B		2.7	10.39	0.74	B
2027										
1 - Great North Road (S)	D3	1.6	6.52	0.61	A	D4	0.7	3.65	0.40	A
2 - Dixons Hill Road		1.0	6.80	0.51	A		2.2	10.21	0.69	B
3 - Great North Road (N)		4.4	14.95	0.82	B		2.9	10.96	0.75	B
2027 + Dev										
1 - Great North Road (S)	D5	1.6	6.56	0.61	A	D6	0.7	3.69	0.40	A
2 - Dixons Hill Road		1.1	6.94	0.52	A		2.2	10.34	0.69	B
3 - Great North Road (N)		4.5	15.28	0.83	C		3.0	11.19	0.75	B

Values shown are the highest values encountered over all time segments. Delay is the maximum value of average delay per arriving vehicle.

File summary

File Description

Title	
Location	
Site number	
Date	17/02/2022
Version	
Status	(new file)
Identifier	
Client	
Jobnumber	
Enumerator	EUR\Danesh.Aryan
Description	

Units

Distance units	Speed units	Traffic units input	Traffic units results	Flow units	Average delay units	Total delay units	Rate of delay units
m	kph	Veh	Veh	perHour	s	-Min	perMin

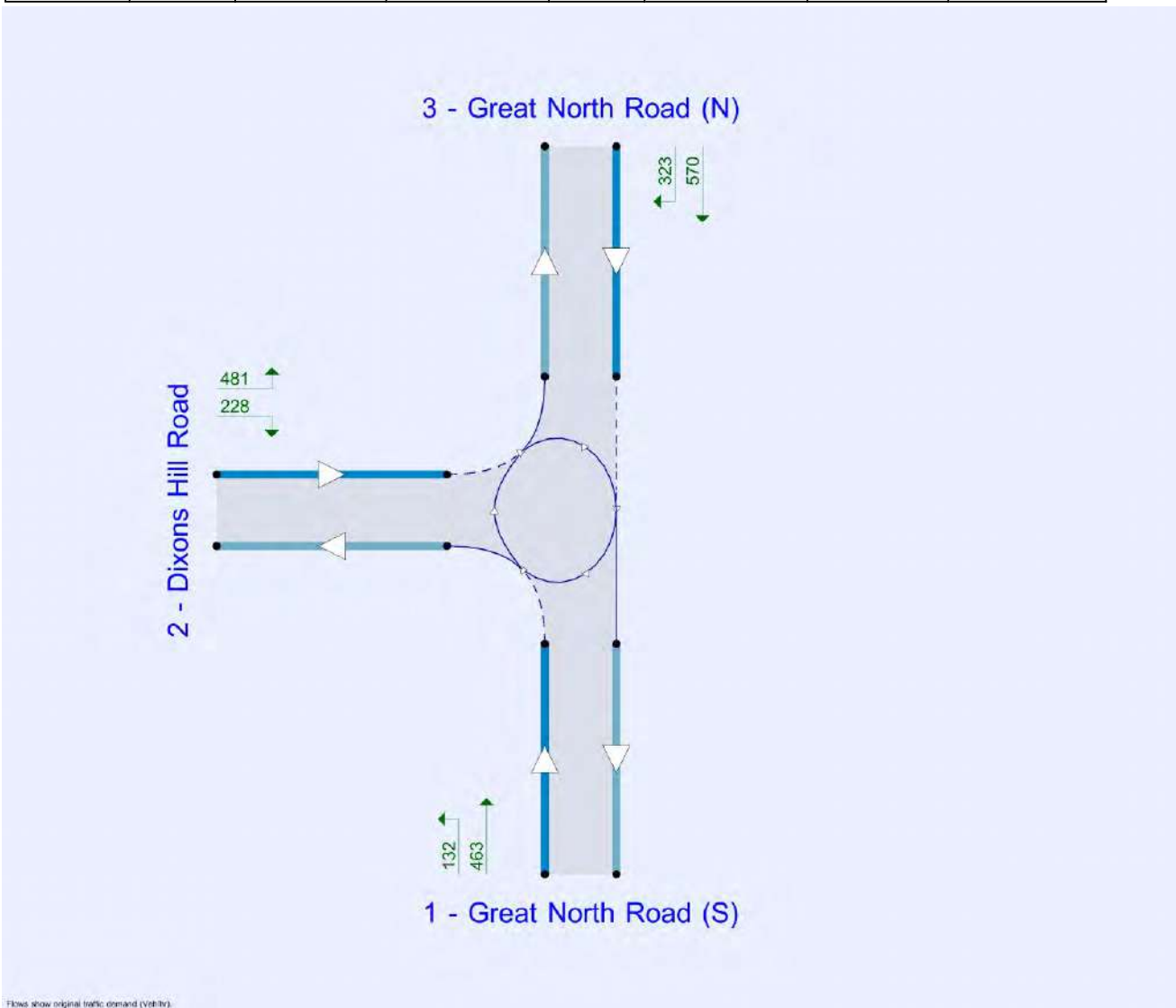

Analysis Options

Vehicle length (m)	Calculate Queue Percentiles	Calculate detailed queueing delay	Show lane queues in feet / metres	Show all PICADY stream intercepts	Calculate residual capacity	RFC Threshold	Average Delay threshold (s)	Queue threshold (PCU)	Use iterations with HCM roundabouts	Max number of iterations for roundabouts
5.75						0.85	36.00	20.00		500

Demand Set Summary

ID	Scenario name	Time Period name	Traffic profile type	Start time (HH:mm)	Finish time (HH:mm)	Time segment length (min)	Run automatically
D1	2022	AM	ONE HOUR	08:00	09:30	15	✓
D2	2022	PM	ONE HOUR	17:00	18:30	15	✓
D3	2027	AM	ONE HOUR	08:00	09:30	15	✓
D4	2027	PM	ONE HOUR	17:00	18:30	15	✓
D5	2027 + Dev	AM	ONE HOUR	08:00	09:30	15	✓
D6	2027 + Dev	PM	ONE HOUR	17:00	18:30	15	✓

Analysis Set Details

ID	Include in report	Network flow scaling factor (%)	Network capacity scaling factor (%)
A1	✓	100.000	100.000

2022, AM

Data Errors and Warnings

No errors or warnings

Junction Network

Junctions

Junction	Name	Junction type	Use circulating lanes	Arm order	Junction Delay (s)	Junction LOS
1	untitled	Standard Roundabout		1, 2, 3	9.73	A

Junction Network

Driving side	Lighting	Network delay (s)	Network LOS
Left	Normal/unknown	9.73	A

Arms

Arms

Arm	Name	Description	No give-way line
1	Great North Road (S)		
2	Dixons Hill Road		
3	Great North Road (N)		

Roundabout Geometry

Arm	V - Approach road half-width (m)	E - Entry width (m)	I' - Effective flare length (m)	R - Entry radius (m)	D - Inscribed circle diameter (m)	PHI - Conflict (entry) angle (deg)	Entry only	Exit only
1 - Great North Road (S)	4.00	8.30	16.4	53.4	35.7	42.0		
2 - Dixons Hill Road	3.10	8.30	8.0	102.3	35.7	40.0		
3 - Great North Road (N)	3.50	6.70	11.9	22.3	35.7	51.0		

Slope / Intercept / Capacity

Roundabout Slope and Intercept used in model

Arm	Final slope	Final intercept (PCU/hr)
1 - Great North Road (S)	0.687	1899
2 - Dixons Hill Road	0.603	1458
3 - Great North Road (N)	0.584	1474

The slope and intercept shown above include any corrections and adjustments.

Traffic Demand

Demand Set Details

ID	Scenario name	Time Period name	Traffic profile type	Start time (HH:mm)	Finish time (HH:mm)	Time segment length (min)	Run automatically
D1	2022	AM	ONE HOUR	08:00	09:30	15	✓

Vehicle mix varies over turn	Vehicle mix varies over entry	Vehicle mix source	PCU Factor for a HV (PCU)
✓	✓	HV Percentages	2.00

Demand overview (Traffic)

Arm	Linked arm	Profile type	Use O-D data	Average Demand (Veh/hr)	Scaling Factor (%)
1 - Great North Road (S)		ONE HOUR	✓	778	100.000
2 - Dixons Hill Road		ONE HOUR	✓	484	100.000
3 - Great North Road (N)		ONE HOUR	✓	986	100.000

Origin-Destination Data

Demand (Veh/hr)

		To		
		1 - Great North Road (S)	2 - Dixons Hill Road	3 - Great North Road (N)
From	1 - Great North Road (S)	1	280	497
	2 - Dixons Hill Road	120	0	364
	3 - Great North Road (N)	455	528	3

Vehicle Mix

Heavy Vehicle Percentages

		To		
		1 - Great North Road (S)	2 - Dixons Hill Road	3 - Great North Road (N)
From	1 - Great North Road (S)	100	3	4
	2 - Dixons Hill Road	1	0	4
	3 - Great North Road (N)	4	4	0

Results

Results Summary for whole modelled period

Arm	Max RFC	Max Delay (s)	Max Queue (Veh)	Max LOS	Average Demand (Veh/hr)	Total Junction Arrivals (Veh)
1 - Great North Road (S)	0.60	6.30	1.5	A	714	1071
2 - Dixons Hill Road	0.50	6.62	1.0	A	444	666
3 - Great North Road (N)	0.81	13.95	4.1	B	905	1357

Main Results for each time segment

08:00 - 08:15

Arm	Total Demand (Veh/hr)	Junction Arrivals (Veh)	Circulating flow (Veh/hr)	Capacity (Veh/hr)	RFC	Throughput (Veh/hr)	Throughput (exit side) (Veh/hr)	Start queue (Veh)	End queue (Veh)	Delay (s)	Unsignalised level of service
1 - Great North Road (S)	586	146	397	1557	0.376	583	431	0.0	0.6	3.689	A
2 - Dixons Hill Road	364	91	376	1183	0.308	363	605	0.0	0.4	4.379	A
3 - Great North Road (N)	742	186	91	1366	0.543	738	648	0.0	1.2	5.688	A

08:15 - 08:30

Arm	Total Demand (Veh/hr)	Junction Arrivals (Veh)	Circulating flow (Veh/hr)	Capacity (Veh/hr)	RFC	Throughput (Veh/hr)	Throughput (exit side) (Veh/hr)	Start queue (Veh)	End queue (Veh)	Delay (s)	Unsignalised level of service
1 - Great North Road (S)	699	175	476	1503	0.465	698	516	0.6	0.9	4.471	A
2 - Dixons Hill Road	435	109	450	1138	0.382	434	725	0.4	0.6	5.110	A
3 - Great North Road (N)	886	222	109	1356	0.654	884	776	1.2	1.8	7.582	A

08:30 - 08:45

Arm	Total Demand (Veh/hr)	Junction Arrivals (Veh)	Circulating flow (Veh/hr)	Capacity (Veh/hr)	RFC	Throughput (Veh/hr)	Throughput (exit side) (Veh/hr)	Start queue (Veh)	End queue (Veh)	Delay (s)	Unsignalised level of service
1 - Great North Road (S)	857	214	580	1431	0.599	854	630	0.9	1.5	6.217	A
2 - Dixons Hill Road	533	133	550	1077	0.495	531	884	0.6	1.0	6.580	A
3 - Great North Road (N)	1086	271	133	1342	0.809	1077	949	1.8	3.9	13.194	B

08:45 - 09:00

Arm	Total Demand (Veh/hr)	Junction Arrivals (Veh)	Circulating flow (Veh/hr)	Capacity (Veh/hr)	RFC	Throughput (Veh/hr)	Throughput (exit side) (Veh/hr)	Start queue (Veh)	End queue (Veh)	Delay (s)	Unsignalised level of service
1 - Great North Road (S)	857	214	584	1428	0.600	857	634	1.5	1.5	6.298	A
2 - Dixons Hill Road	533	133	552	1076	0.495	533	889	1.0	1.0	6.625	A
3 - Great North Road (N)	1086	271	133	1342	0.809	1085	951	3.9	4.1	13.949	B

09:00 - 09:15

Arm	Total Demand (Veh/hr)	Junction Arrivals (Veh)	Circulating flow (Veh/hr)	Capacity (Veh/hr)	RFC	Throughput (Veh/hr)	Throughput (exit side) (Veh/hr)	Start queue (Veh)	End queue (Veh)	Delay (s)	Unsignalised level of service
1 - Great North Road (S)	699	175	482	1498	0.467	702	522	1.5	0.9	4.532	A
2 - Dixons Hill Road	435	109	452	1137	0.383	436	732	1.0	0.6	5.152	A
3 - Great North Road (N)	886	222	109	1355	0.654	895	779	4.1	1.9	7.959	A

09:15 - 09:30

Arm	Total Demand (Veh/hr)	Junction Arrivals (Veh)	Circulating flow (Veh/hr)	Capacity (Veh/hr)	RFC	Throughput (Veh/hr)	Throughput (exit side) (Veh/hr)	Start queue (Veh)	End queue (Veh)	Delay (s)	Unsignalised level of service
1 - Great North Road (S)	586	146	401	1554	0.377	587	435	0.9	0.6	3.728	A
2 - Dixons Hill Road	364	91	378	1182	0.308	365	610	0.6	0.4	4.411	A
3 - Great North Road (N)	742	186	91	1366	0.544	745	652	1.9	1.2	5.828	A

2022, PM

Data Errors and Warnings

No errors or warnings

Junction Network

Junctions

Junction	Name	Junction type	Use circulating lanes	Arm order	Junction Delay (s)	Junction LOS
1	untitled	Standard Roundabout		1, 2, 3	8.35	A

Junction Network

Driving side	Lighting	Network delay (s)	Network LOS
Left	Normal/unknown	8.35	A

Traffic Demand

Demand Set Details

ID	Scenario name	Time Period name	Traffic profile type	Start time (HH:mm)	Finish time (HH:mm)	Time segment length (min)	Run automatically
D2	2022	PM	ONE HOUR	17:00	18:30	15	✓

Vehicle mix varies over turn	Vehicle mix varies over entry	Vehicle mix source	PCU Factor for a HV (PCU)
✓	✓	HV Percentages	2.00

Demand overview (Traffic)

Arm	Linked arm	Profile type	Use O-D data	Average Demand (Veh/hr)	Scaling Factor (%)
1 - Great North Road (S)		ONE HOUR	✓	581	100.000
2 - Dixons Hill Road		ONE HOUR	✓	693	100.000
3 - Great North Road (N)		ONE HOUR	✓	874	100.000

Origin-Destination Data

Demand (Veh/hr)

		To		
		1 - Great North Road (S)	2 - Dixons Hill Road	3 - Great North Road (N)
From	1 - Great North Road (S)	0	125	456
	2 - Dixons Hill Road	222	0	471
	3 - Great North Road (N)	561	313	0

Vehicle Mix

Heavy Vehicle Percentages

		To		
		1 - Great North Road (S)	2 - Dixons Hill Road	3 - Great North Road (N)
From	1 - Great North Road (S)	0	1	1
	2 - Dixons Hill Road	1	0	2
	3 - Great North Road (N)	1	3	0

Results

Results Summary for whole modelled period

Arm	Max RFC	Max Delay (s)	Max Queue (Veh)	Max LOS	Average Demand (Veh/hr)	Total Junction Arrivals (Veh)
1 - Great North Road (S)	0.39	3.60	0.6	A	533	800
2 - Dixons Hill Road	0.67	9.72	2.0	A	636	954
3 - Great North Road (N)	0.74	10.39	2.7	B	802	1203

Main Results for each time segment

17:00 - 17:15

Arm	Total Demand (Veh/hr)	Junction Arrivals (Veh)	Circulating flow (Veh/hr)	Capacity (Veh/hr)	RFC	Throughput (Veh/hr)	Throughput (exit side) (Veh/hr)	Start queue (Veh)	End queue (Veh)	Delay (s)	Unsignalised level of service
1 - Great North Road (S)	437	109	234	1716	0.255	436	586	0.0	0.3	2.810	A
2 - Dixons Hill Road	522	130	342	1229	0.425	519	328	0.0	0.7	5.052	A
3 - Great North Road (N)	658	164	166	1353	0.486	654	695	0.0	0.9	5.125	A

17:15 - 17:30

Arm	Total Demand (Veh/hr)	Junction Arrivals (Veh)	Circulating flow (Veh/hr)	Capacity (Veh/hr)	RFC	Throughput (Veh/hr)	Throughput (exit side) (Veh/hr)	Start queue (Veh)	End queue (Veh)	Delay (s)	Unsignalised level of service
1 - Great North Road (S)	522	131	281	1684	0.310	522	702	0.3	0.4	3.099	A
2 - Dixons Hill Road	623	156	410	1188	0.524	622	393	0.7	1.1	6.338	A
3 - Great North Road (N)	786	196	199	1334	0.589	784	832	0.9	1.4	6.521	A

17:30 - 17:45

Arm	Total Demand (Veh/hr)	Junction Arrivals (Veh)	Circulating flow (Veh/hr)	Capacity (Veh/hr)	RFC	Throughput (Veh/hr)	Throughput (exit side) (Veh/hr)	Start queue (Veh)	End queue (Veh)	Delay (s)	Unsignalised level of service
1 - Great North Road (S)	640	160	343	1640	0.390	639	858	0.4	0.6	3.594	A
2 - Dixons Hill Road	763	191	501	1133	0.673	759	480	1.1	2.0	9.535	A
3 - Great North Road (N)	962	241	243	1308	0.735	957	1018	1.4	2.7	10.105	B

17:45 - 18:00

Arm	Total Demand (Veh/hr)	Junction Arrivals (Veh)	Circulating flow (Veh/hr)	Capacity (Veh/hr)	RFC	Throughput (Veh/hr)	Throughput (exit side) (Veh/hr)	Start queue (Veh)	End queue (Veh)	Delay (s)	Unsignalised level of service
1 - Great North Road (S)	640	160	345	1639	0.390	640	862	0.6	0.6	3.601	A
2 - Dixons Hill Road	763	191	502	1133	0.674	763	482	2.0	2.0	9.721	A
3 - Great North Road (N)	962	241	244	1308	0.736	962	1021	2.7	2.7	10.395	B

18:00 - 18:15

Arm	Total Demand (Veh/hr)	Junction Arrivals (Veh)	Circulating flow (Veh/hr)	Capacity (Veh/hr)	RFC	Throughput (Veh/hr)	Throughput (exit side) (Veh/hr)	Start queue (Veh)	End queue (Veh)	Delay (s)	Unsignalised level of service
1 - Great North Road (S)	522	131	283	1682	0.311	523	708	0.6	0.5	3.110	A
2 - Dixons Hill Road	623	156	411	1188	0.525	627	396	2.0	1.1	6.456	A
3 - Great North Road (N)	786	196	201	1333	0.589	791	836	2.7	1.5	6.700	A

18:15 - 18:30

Arm	Total Demand (Veh/hr)	Junction Arrivals (Veh)	Circulating flow (Veh/hr)	Capacity (Veh/hr)	RFC	Throughput (Veh/hr)	Throughput (exit side) (Veh/hr)	Start queue (Veh)	End queue (Veh)	Delay (s)	Unsignalised level of service
1 - Great North Road (S)	437	109	236	1715	0.255	438	591	0.5	0.3	2.821	A
2 - Dixons Hill Road	522	130	344	1228	0.425	523	331	1.1	0.7	5.120	A
3 - Great North Road (N)	658	164	168	1352	0.487	660	699	1.5	1.0	5.216	A

2027, AM

Data Errors and Warnings

No errors or warnings

Junction Network

Junctions

Junction	Name	Junction type	Use circulating lanes	Arm order	Junction Delay (s)	Junction LOS
1	untitled	Standard Roundabout		1, 2, 3	10.29	B

Junction Network

Driving side	Lighting	Network delay (s)	Network LOS
Left	Normal/unknown	10.29	B

Traffic Demand

Demand Set Details

ID	Scenario name	Time Period name	Traffic profile type	Start time (HH:mm)	Finish time (HH:mm)	Time segment length (min)	Run automatically
D3	2027	AM	ONE HOUR	08:00	09:30	15	✓

Vehicle mix varies over turn	Vehicle mix varies over entry	Vehicle mix source	PCU Factor for a HV (PCU)
✓	✓	HV Percentages	2.00

Demand overview (Traffic)

Arm	Linked arm	Profile type	Use O-D data	Average Demand (Veh/hr)	Scaling Factor (%)
1 - Great North Road (S)		ONE HOUR	✓	790	100.000
2 - Dixons Hill Road		ONE HOUR	✓	492	100.000
3 - Great North Road (N)		ONE HOUR	✓	1001	100.000

Origin-Destination Data

Demand (Veh/hr)

		To		
		1 - Great North Road (S)	2 - Dixons Hill Road	3 - Great North Road (N)
From	1 - Great North Road (S)	1	284	505
	2 - Dixons Hill Road	122	0	370
	3 - Great North Road (N)	462	536	3

Vehicle Mix

Heavy Vehicle Percentages

		To		
		1 - Great North Road (S)	2 - Dixons Hill Road	3 - Great North Road (N)
From	1 - Great North Road (S)	100	3	4
	2 - Dixons Hill Road	1	0	4
	3 - Great North Road (N)	4	4	0

Results

Results Summary for whole modelled period

Arm	Max RFC	Max Delay (s)	Max Queue (Veh)	Max LOS	Average Demand (Veh/hr)	Total Junction Arrivals (Veh)
1 - Great North Road (S)	0.61	6.52	1.6	A	725	1087
2 - Dixons Hill Road	0.51	6.80	1.0	A	451	677
3 - Great North Road (N)	0.82	14.95	4.4	B	919	1378

Main Results for each time segment

08:00 - 08:15

Arm	Total Demand (Veh/hr)	Junction Arrivals (Veh)	Circulating flow (Veh/hr)	Capacity (Veh/hr)	RFC	Throughput (Veh/hr)	Throughput (exit side) (Veh/hr)	Start queue (Veh)	End queue (Veh)	Delay (s)	Unsignalised level of service
1 - Great North Road (S)	595	149	403	1553	0.383	592	438	0.0	0.6	3.739	A
2 - Dixons Hill Road	370	93	382	1180	0.314	369	614	0.0	0.5	4.429	A
3 - Great North Road (N)	754	188	92	1365	0.552	749	658	0.0	1.2	5.796	A

08:15 - 08:30

Arm	Total Demand (Veh/hr)	Junction Arrivals (Veh)	Circulating flow (Veh/hr)	Capacity (Veh/hr)	RFC	Throughput (Veh/hr)	Throughput (exit side) (Veh/hr)	Start queue (Veh)	End queue (Veh)	Delay (s)	Unsignalised level of service
1 - Great North Road (S)	710	178	483	1498	0.474	709	524	0.6	0.9	4.558	A
2 - Dixons Hill Road	442	111	457	1134	0.390	442	735	0.5	0.6	5.195	A
3 - Great North Road (N)	900	225	110	1355	0.664	897	788	1.2	1.9	7.815	A

08:30 - 08:45

Arm	Total Demand (Veh/hr)	Junction Arrivals (Veh)	Circulating flow (Veh/hr)	Capacity (Veh/hr)	RFC	Throughput (Veh/hr)	Throughput (exit side) (Veh/hr)	Start queue (Veh)	End queue (Veh)	Delay (s)	Unsignalised level of service
1 - Great North Road (S)	870	217	588	1425	0.610	867	639	0.9	1.5	6.424	A
2 - Dixons Hill Road	542	135	559	1072	0.505	540	897	0.6	1.0	6.752	A
3 - Great North Road (N)	1102	276	135	1341	0.822	1093	964	1.9	4.3	14.017	B

08:45 - 09:00

Arm	Total Demand (Veh/hr)	Junction Arrivals (Veh)	Circulating flow (Veh/hr)	Capacity (Veh/hr)	RFC	Throughput (Veh/hr)	Throughput (exit side) (Veh/hr)	Start queue (Veh)	End queue (Veh)	Delay (s)	Unsignalised level of service
1 - Great North Road (S)	870	217	593	1422	0.612	870	644	1.5	1.6	6.517	A
2 - Dixons Hill Road	542	135	560	1071	0.506	542	902	1.0	1.0	6.802	A
3 - Great North Road (N)	1102	276	135	1340	0.822	1101	967	4.3	4.4	14.953	B

09:00 - 09:15

Arm	Total Demand (Veh/hr)	Junction Arrivals (Veh)	Circulating flow (Veh/hr)	Capacity (Veh/hr)	RFC	Throughput (Veh/hr)	Throughput (exit side) (Veh/hr)	Start queue (Veh)	End queue (Veh)	Delay (s)	Unsignalised level of service
1 - Great North Road (S)	710	178	490	1493	0.476	713	531	1.6	0.9	4.630	A
2 - Dixons Hill Road	442	111	459	1132	0.391	444	743	1.0	0.6	5.240	A
3 - Great North Road (N)	900	225	111	1354	0.664	909	792	4.4	2.0	8.258	A

09:15 - 09:30

Arm	Total Demand (Veh/hr)	Junction Arrivals (Veh)	Circulating flow (Veh/hr)	Capacity (Veh/hr)	RFC	Throughput (Veh/hr)	Throughput (exit side) (Veh/hr)	Start queue (Veh)	End queue (Veh)	Delay (s)	Unsignalised level of service
1 - Great North Road (S)	595	149	407	1550	0.384	596	442	0.9	0.6	3.777	A
2 - Dixons Hill Road	370	93	384	1178	0.314	371	619	0.6	0.5	4.466	A
3 - Great North Road (N)	754	188	93	1365	0.552	757	662	2.0	1.3	5.949	A

2027, PM

Data Errors and Warnings

No errors or warnings

Junction Network

Junctions

Junction	Name	Junction type	Use circulating lanes	Arm order	Junction Delay (s)	Junction LOS
1	untitled	Standard Roundabout		1, 2, 3	8.75	A

Junction Network

Driving side	Lighting	Network delay (s)	Network LOS
Left	Normal/unknown	8.75	A

Traffic Demand

Demand Set Details

ID	Scenario name	Time Period name	Traffic profile type	Start time (HH:mm)	Finish time (HH:mm)	Time segment length (min)	Run automatically
D4	2027	PM	ONE HOUR	17:00	18:30	15	✓

Vehicle mix varies over turn	Vehicle mix varies over entry	Vehicle mix source	PCU Factor for a HV (PCU)
✓	✓	HV Percentages	2.00

Demand overview (Traffic)

Arm	Linked arm	Profile type	Use O-D data	Average Demand (Veh/hr)	Scaling Factor (%)
1 - Great North Road (S)		ONE HOUR	✓	590	100.000
2 - Dixons Hill Road		ONE HOUR	✓	705	100.000
3 - Great North Road (N)		ONE HOUR	✓	888	100.000

Origin-Destination Data

Demand (Veh/hr)

		To		
		1 - Great North Road (S)	2 - Dixons Hill Road	3 - Great North Road (N)
From	1 - Great North Road (S)	0	127	463
	2 - Dixons Hill Road	226	0	479
	3 - Great North Road (N)	570	318	0

Vehicle Mix

Heavy Vehicle Percentages

		To		
		1 - Great North Road (S)	2 - Dixons Hill Road	3 - Great North Road (N)
From	1 - Great North Road (S)	0	1	1
	2 - Dixons Hill Road	1	0	2
	3 - Great North Road (N)	1	3	0

Results

Results Summary for whole modelled period

Arm	Max RFC	Max Delay (s)	Max Queue (Veh)	Max LOS	Average Demand (Veh/hr)	Total Junction Arrivals (Veh)
1 - Great North Road (S)	0.40	3.65	0.7	A	541	812
2 - Dixons Hill Road	0.69	10.21	2.2	B	647	970
3 - Great North Road (N)	0.75	10.96	2.9	B	815	1222

Main Results for each time segment

17:00 - 17:15

Arm	Total Demand (Veh/hr)	Junction Arrivals (Veh)	Circulating flow (Veh/hr)	Capacity (Veh/hr)	RFC	Throughput (Veh/hr)	Throughput (exit side) (Veh/hr)	Start queue (Veh)	End queue (Veh)	Delay (s)	Unsignalised level of service
1 - Great North Road (S)	444	111	238	1714	0.259	443	596	0.0	0.3	2.830	A
2 - Dixons Hill Road	531	133	347	1225	0.433	528	333	0.0	0.8	5.139	A
3 - Great North Road (N)	669	167	169	1351	0.495	665	706	0.0	1.0	5.213	A

17:15 - 17:30

Arm	Total Demand (Veh/hr)	Junction Arrivals (Veh)	Circulating flow (Veh/hr)	Capacity (Veh/hr)	RFC	Throughput (Veh/hr)	Throughput (exit side) (Veh/hr)	Start queue (Veh)	End queue (Veh)	Delay (s)	Unsignalised level of service
1 - Great North Road (S)	530	133	285	1681	0.316	530	714	0.3	0.5	3.129	A
2 - Dixons Hill Road	634	158	416	1184	0.535	632	399	0.8	1.1	6.500	A
3 - Great North Road (N)	798	200	203	1332	0.599	796	845	1.0	1.5	6.694	A

17:30 - 17:45

Arm	Total Demand (Veh/hr)	Junction Arrivals (Veh)	Circulating flow (Veh/hr)	Capacity (Veh/hr)	RFC	Throughput (Veh/hr)	Throughput (exit side) (Veh/hr)	Start queue (Veh)	End queue (Veh)	Delay (s)	Unsignalised level of service
1 - Great North Road (S)	650	162	348	1636	0.397	649	872	0.5	0.7	3.641	A
2 - Dixons Hill Road	776	194	509	1129	0.688	772	488	1.1	2.1	9.989	A
3 - Great North Road (N)	978	244	248	1306	0.749	972	1034	1.5	2.8	10.611	B

17:45 - 18:00

Arm	Total Demand (Veh/hr)	Junction Arrivals (Veh)	Circulating flow (Veh/hr)	Capacity (Veh/hr)	RFC	Throughput (Veh/hr)	Throughput (exit side) (Veh/hr)	Start queue (Veh)	End queue (Veh)	Delay (s)	Unsignalised level of service
1 - Great North Road (S)	650	162	350	1635	0.397	650	876	0.7	0.7	3.652	A
2 - Dixons Hill Road	776	194	510	1128	0.688	776	490	2.1	2.2	10.209	B
3 - Great North Road (N)	978	244	249	1305	0.749	977	1037	2.8	2.9	10.958	B

18:00 - 18:15

Arm	Total Demand (Veh/hr)	Junction Arrivals (Veh)	Circulating flow (Veh/hr)	Capacity (Veh/hr)	RFC	Throughput (Veh/hr)	Throughput (exit side) (Veh/hr)	Start queue (Veh)	End queue (Veh)	Delay (s)	Unsignalised level of service
1 - Great North Road (S)	530	133	288	1679	0.316	531	720	0.7	0.5	3.138	A
2 - Dixons Hill Road	634	158	417	1184	0.535	638	402	2.2	1.2	6.640	A
3 - Great North Road (N)	798	200	204	1331	0.600	804	850	2.9	1.5	6.901	A

18:15 - 18:30

Arm	Total Demand (Veh/hr)	Junction Arrivals (Veh)	Circulating flow (Veh/hr)	Capacity (Veh/hr)	RFC	Throughput (Veh/hr)	Throughput (exit side) (Veh/hr)	Start queue (Veh)	End queue (Veh)	Delay (s)	Unsignalised level of service
1 - Great North Road (S)	444	111	240	1712	0.259	445	601	0.5	0.4	2.840	A
2 - Dixons Hill Road	531	133	349	1225	0.433	532	336	1.2	0.8	5.214	A
3 - Great North Road (N)	669	167	171	1351	0.495	671	711	1.5	1.0	5.313	A

2027 + Dev, AM

Data Errors and Warnings

No errors or warnings

Junction Network

Junctions

Junction	Name	Junction type	Use circulating lanes	Arm order	Junction Delay (s)	Junction LOS
1	untitled	Standard Roundabout		1, 2, 3	10.46	B

Junction Network

Driving side	Lighting	Network delay (s)	Network LOS
Left	Normal/unknown	10.46	B

Traffic Demand

Demand Set Details

ID	Scenario name	Time Period name	Traffic profile type	Start time (HH:mm)	Finish time (HH:mm)	Time segment length (min)	Run automatically
D5	2027 + Dev	AM	ONE HOUR	08:00	09:30	15	✓

Vehicle mix varies over turn	Vehicle mix varies over entry	Vehicle mix source	PCU Factor for a HV (PCU)
✓	✓	HV Percentages	2.00

Demand overview (Traffic)

Arm	Linked arm	Profile type	Use O-D data	Average Demand (Veh/hr)	Scaling Factor (%)
1 - Great North Road (S)		ONE HOUR	✓	792	100.000
2 - Dixons Hill Road		ONE HOUR	✓	502	100.000
3 - Great North Road (N)		ONE HOUR	✓	1003	100.000

Origin-Destination Data

Demand (Veh/hr)

		To		
		1 - Great North Road (S)	2 - Dixons Hill Road	3 - Great North Road (N)
From	1 - Great North Road (S)	1	286	505
	2 - Dixons Hill Road	127	0	375
	3 - Great North Road (N)	462	538	3

Vehicle Mix

Heavy Vehicle Percentages

		To		
		1 - Great North Road (S)	2 - Dixons Hill Road	3 - Great North Road (N)
From	1 - Great North Road (S)	100	3	4
	2 - Dixons Hill Road	1	0	4
	3 - Great North Road (N)	4	4	0

Results

Results Summary for whole modelled period

Arm	Max RFC	Max Delay (s)	Max Queue (Veh)	Max LOS	Average Demand (Veh/hr)	Total Junction Arrivals (Veh)
1 - Great North Road (S)	0.61	6.56	1.6	A	727	1090
2 - Dixons Hill Road	0.52	6.94	1.1	A	461	691
3 - Great North Road (N)	0.83	15.28	4.5	C	920	1381

Main Results for each time segment

08:00 - 08:15

Arm	Total Demand (Veh/hr)	Junction Arrivals (Veh)	Circulating flow (Veh/hr)	Capacity (Veh/hr)	RFC	Throughput (Veh/hr)	Throughput (exit side) (Veh/hr)	Start queue (Veh)	End queue (Veh)	Delay (s)	Unsignalised level of service
1 - Great North Road (S)	596	149	405	1552	0.384	594	441	0.0	0.6	3.749	A
2 - Dixons Hill Road	378	94	382	1180	0.320	376	617	0.0	0.5	4.470	A
3 - Great North Road (N)	755	189	96	1363	0.554	750	662	0.0	1.2	5.828	A

08:15 - 08:30

Arm	Total Demand (Veh/hr)	Junction Arrivals (Veh)	Circulating flow (Veh/hr)	Capacity (Veh/hr)	RFC	Throughput (Veh/hr)	Throughput (exit side) (Veh/hr)	Start queue (Veh)	End queue (Veh)	Delay (s)	Unsignalised level of service
1 - Great North Road (S)	712	178	485	1497	0.476	711	529	0.6	0.9	4.575	A
2 - Dixons Hill Road	451	113	457	1134	0.398	451	739	0.5	0.7	5.262	A
3 - Great North Road (N)	902	225	115	1352	0.667	899	793	1.2	2.0	7.887	A

08:30 - 08:45

Arm	Total Demand (Veh/hr)	Junction Arrivals (Veh)	Circulating flow (Veh/hr)	Capacity (Veh/hr)	RFC	Throughput (Veh/hr)	Throughput (exit side) (Veh/hr)	Start queue (Veh)	End queue (Veh)	Delay (s)	Unsignalised level of service
1 - Great North Road (S)	872	218	590	1424	0.613	869	645	0.9	1.6	6.463	A
2 - Dixons Hill Road	553	138	559	1072	0.516	551	901	0.7	1.0	6.890	A
3 - Great North Road (N)	1104	276	141	1338	0.826	1095	969	2.0	4.4	14.284	B

08:45 - 09:00

Arm	Total Demand (Veh/hr)	Junction Arrivals (Veh)	Circulating flow (Veh/hr)	Capacity (Veh/hr)	RFC	Throughput (Veh/hr)	Throughput (exit side) (Veh/hr)	Start queue (Veh)	End queue (Veh)	Delay (s)	Unsignalised level of service
1 - Great North Road (S)	872	218	595	1420	0.614	872	649	1.6	1.6	6.561	A
2 - Dixons Hill Road	553	138	560	1071	0.516	553	907	1.0	1.1	6.944	A
3 - Great North Road (N)	1104	276	141	1337	0.826	1104	972	4.4	4.5	15.282	C

09:00 - 09:15

Arm	Total Demand (Veh/hr)	Junction Arrivals (Veh)	Circulating flow (Veh/hr)	Capacity (Veh/hr)	RFC	Throughput (Veh/hr)	Throughput (exit side) (Veh/hr)	Start queue (Veh)	End queue (Veh)	Delay (s)	Unsignalised level of service
1 - Great North Road (S)	712	178	492	1492	0.477	715	535	1.6	0.9	4.647	A
2 - Dixons Hill Road	451	113	459	1132	0.398	453	747	1.1	0.7	5.310	A
3 - Great North Road (N)	902	225	115	1352	0.667	912	797	4.5	2.1	8.353	A

09:15 - 09:30

Arm	Total Demand (Veh/hr)	Junction Arrivals (Veh)	Circulating flow (Veh/hr)	Capacity (Veh/hr)	RFC	Throughput (Veh/hr)	Throughput (exit side) (Veh/hr)	Start queue (Veh)	End queue (Veh)	Delay (s)	Unsignalised level of service
1 - Great North Road (S)	596	149	409	1549	0.385	597	446	0.9	0.6	3.791	A
2 - Dixons Hill Road	378	94	384	1178	0.321	379	622	0.7	0.5	4.508	A
3 - Great North Road (N)	755	189	97	1363	0.554	758	666	2.1	1.3	5.987	A

2027 + Dev, PM

Data Errors and Warnings

No errors or warnings

Junction Network

Junctions

Junction	Name	Junction type	Use circulating lanes	Arm order	Junction Delay (s)	Junction LOS
1	untitled	Standard Roundabout		1, 2, 3	8.89	A

Junction Network

Driving side	Lighting	Network delay (s)	Network LOS
Left	Normal/unknown	8.89	A

Traffic Demand

Demand Set Details

ID	Scenario name	Time Period name	Traffic profile type	Start time (HH:mm)	Finish time (HH:mm)	Time segment length (min)	Run automatically
D6	2027 + Dev	PM	ONE HOUR	17:00	18:30	15	✓

Vehicle mix varies over turn	Vehicle mix varies over entry	Vehicle mix source	PCU Factor for a HV (PCU)
✓	✓	HV Percentages	2.00

Demand overview (Traffic)

Arm	Linked arm	Profile type	Use O-D data	Average Demand (Veh/hr)	Scaling Factor (%)
1 - Great North Road (S)		ONE HOUR	✓	595	100.000
2 - Dixons Hill Road		ONE HOUR	✓	709	100.000
3 - Great North Road (N)		ONE HOUR	✓	893	100.000

Origin-Destination Data

Demand (Veh/hr)

		To		
		1 - Great North Road (S)	2 - Dixons Hill Road	3 - Great North Road (N)
From	1 - Great North Road (S)	0	132	463
	2 - Dixons Hill Road	228	0	481
	3 - Great North Road (N)	570	323	0

Vehicle Mix

Heavy Vehicle Percentages

		To		
		1 - Great North Road (S)	2 - Dixons Hill Road	3 - Great North Road (N)
From	1 - Great North Road (S)	0	1	1
	2 - Dixons Hill Road	1	0	2
	3 - Great North Road (N)	1	3	0

Results

Results Summary for whole modelled period

Arm	Max RFC	Max Delay (s)	Max Queue (Veh)	Max LOS	Average Demand (Veh/hr)	Total Junction Arrivals (Veh)
1 - Great North Road (S)	0.40	3.69	0.7	A	546	819
2 - Dixons Hill Road	0.69	10.34	2.2	B	651	976
3 - Great North Road (N)	0.75	11.19	3.0	B	819	1229

Main Results for each time segment

17:00 - 17:15

Arm	Total Demand (Veh/hr)	Junction Arrivals (Veh)	Circulating flow (Veh/hr)	Capacity (Veh/hr)	RFC	Throughput (Veh/hr)	Throughput (exit side) (Veh/hr)	Start queue (Veh)	End queue (Veh)	Delay (s)	Unsignalised level of service
1 - Great North Road (S)	448	112	242	1711	0.262	447	597	0.0	0.4	2.845	A
2 - Dixons Hill Road	534	133	347	1225	0.436	531	341	0.0	0.8	5.159	A
3 - Great North Road (N)	672	168	171	1350	0.498	668	708	0.0	1.0	5.250	A

17:15 - 17:30

Arm	Total Demand (Veh/hr)	Junction Arrivals (Veh)	Circulating flow (Veh/hr)	Capacity (Veh/hr)	RFC	Throughput (Veh/hr)	Throughput (exit side) (Veh/hr)	Start queue (Veh)	End queue (Veh)	Delay (s)	Unsignalised level of service
1 - Great North Road (S)	535	134	290	1677	0.319	534	716	0.4	0.5	3.147	A
2 - Dixons Hill Road	637	159	416	1185	0.538	636	408	0.8	1.1	6.543	A
3 - Great North Road (N)	803	201	204	1331	0.603	801	847	1.0	1.5	6.763	A

17:30 - 17:45

Arm	Total Demand (Veh/hr)	Junction Arrivals (Veh)	Circulating flow (Veh/hr)	Capacity (Veh/hr)	RFC	Throughput (Veh/hr)	Throughput (exit side) (Veh/hr)	Start queue (Veh)	End queue (Veh)	Delay (s)	Unsignalised level of service
1 - Great North Road (S)	655	164	354	1633	0.401	654	874	0.5	0.7	3.676	A
2 - Dixons Hill Road	781	195	509	1129	0.692	777	499	1.1	2.2	10.107	B
3 - Great North Road (N)	983	246	250	1305	0.754	978	1036	1.5	2.9	10.818	B

17:45 - 18:00

Arm	Total Demand (Veh/hr)	Junction Arrivals (Veh)	Circulating flow (Veh/hr)	Capacity (Veh/hr)	RFC	Throughput (Veh/hr)	Throughput (exit side) (Veh/hr)	Start queue (Veh)	End queue (Veh)	Delay (s)	Unsignalised level of service
1 - Great North Road (S)	655	164	356	1631	0.402	655	878	0.7	0.7	3.687	A
2 - Dixons Hill Road	781	195	510	1128	0.692	780	501	2.2	2.2	10.338	B
3 - Great North Road (N)	983	246	251	1304	0.754	983	1039	2.9	3.0	11.191	B

18:00 - 18:15

Arm	Total Demand (Veh/hr)	Junction Arrivals (Veh)	Circulating flow (Veh/hr)	Capacity (Veh/hr)	RFC	Throughput (Veh/hr)	Throughput (exit side) (Veh/hr)	Start queue (Veh)	End queue (Veh)	Delay (s)	Unsignalised level of service
1 - Great North Road (S)	535	134	292	1675	0.319	536	722	0.7	0.5	3.160	A
2 - Dixons Hill Road	637	159	417	1184	0.538	641	411	2.2	1.2	6.684	A
3 - Great North Road (N)	803	201	206	1330	0.604	809	852	3.0	1.6	6.980	A

18:15 - 18:30

Arm	Total Demand (Veh/hr)	Junction Arrivals (Veh)	Circulating flow (Veh/hr)	Capacity (Veh/hr)	RFC	Throughput (Veh/hr)	Throughput (exit side) (Veh/hr)	Start queue (Veh)	End queue (Veh)	Delay (s)	Unsignalised level of service
1 - Great North Road (S)	448	112	244	1709	0.262	448	603	0.5	0.4	2.855	A
2 - Dixons Hill Road	534	133	349	1225	0.436	535	343	1.2	0.8	5.235	A
3 - Great North Road (N)	672	168	172	1350	0.498	674	712	1.6	1.0	5.349	A

Junctions 10
PICADY 10 - Priority Intersection Module
Version: 10.0.3.1598 © Copyright TRL Software Limited, 2021
For sales and distribution information, program advice and maintenance, contact TRL Software: +44 (0)1344 379777 software@trl.co.uk trlsoftware.com
The users of this computer program for the solution of an engineering problem are in no way relieved of their responsibility for the correctness of the solution

Filename: Dixons Hill Road.Swanland Road Priority Junction.j10
Path: P:\JNY11289 - Colney Heath\Transport\Picady
Report generation date: 27/04/2022 14:05:15

- »2022, AM
- »2022, PM
- »2027, AM
- »2027, PM
- »2027 + Dev, AM
- »2027 + Dev, PM

Summary of junction performance

	AM					PM				
	Set ID	Queue (Veh)	Delay (s)	RFC	LOS	Set ID	Queue (Veh)	Delay (s)	RFC	LOS
2022										
Stream B-C	D1	0.2	10.26	0.16	B	D2	0.2	9.81	0.17	A
Stream B-A		0.9	19.56	0.47	C		0.9	18.51	0.49	C
Stream C-AB		0.3	7.25	0.19	A		0.3	5.67	0.16	A
2027										
Stream B-C	D3	0.2	10.47	0.17	B	D4	0.2	10.02	0.18	B
Stream B-A		0.9	20.12	0.49	C		1.0	19.12	0.50	C
Stream C-AB		0.3	7.28	0.19	A		0.3	5.69	0.16	A
2027 + Dev										
Stream B-C	D5	0.2	10.64	0.17	B	D6	0.2	10.29	0.19	B
Stream B-A		1.0	20.76	0.49	C		1.0	19.69	0.51	C
Stream C-AB		0.4	7.35	0.21	A		0.3	5.73	0.17	A

There are warnings associated with one or more model runs - see the 'Data Errors and Warnings' tables for each Analysis or Demand Set.

Values shown are the highest values encountered over all time segments. Delay is the maximum value of average delay per arriving vehicle.

File summary

File Description

Title	
Location	
Site number	
Date	17/02/2022
Version	
Status	(new file)
Identifier	
Client	
Jobnumber	
Enumerator	EUR\Danesh.Aryan
Description	

Units

Distance units	Speed units	Traffic units input	Traffic units results	Flow units	Average delay units	Total delay units	Rate of delay units
m	kph	Veh	Veh	perHour	s	-Min	perMin

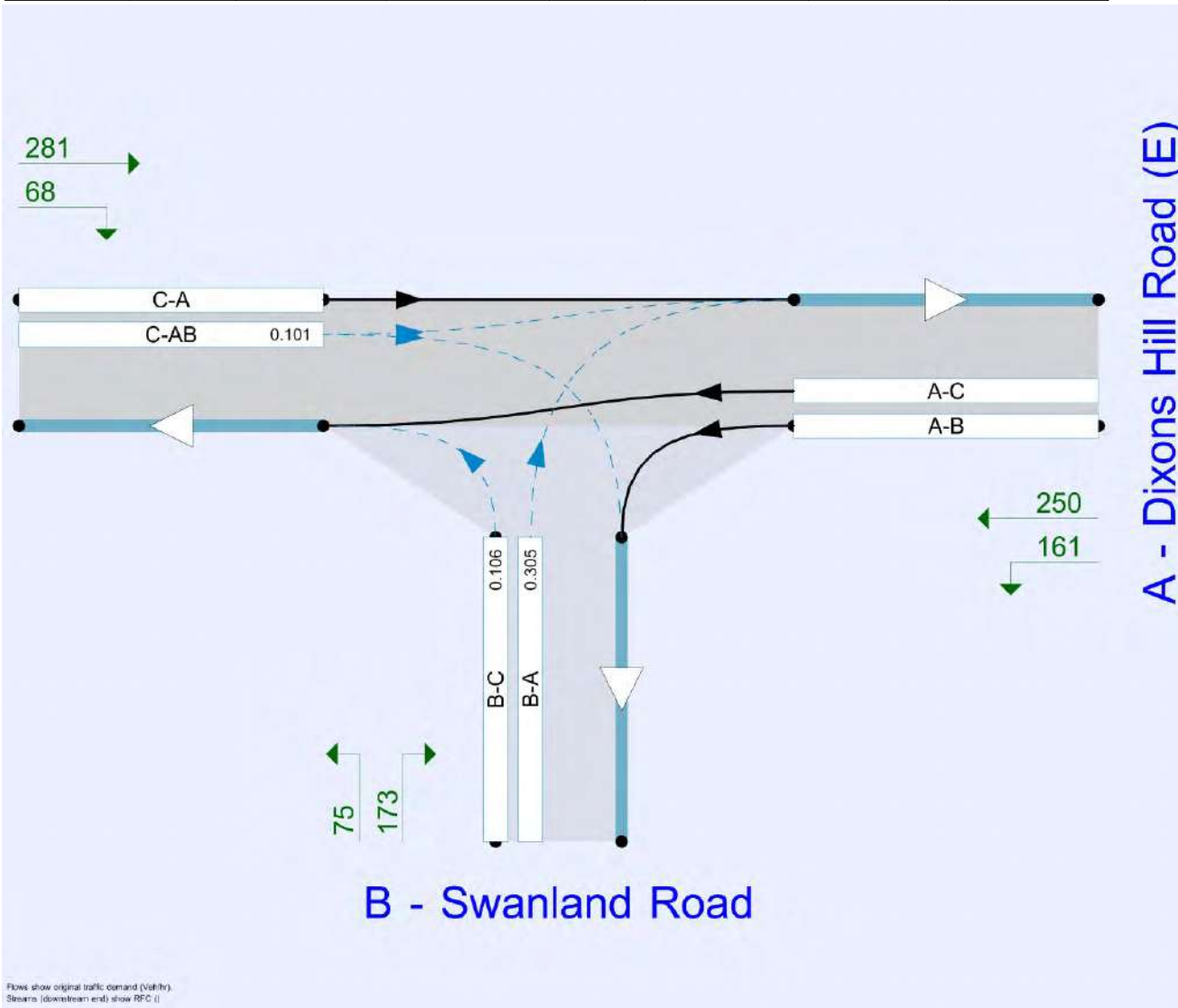

Analysis Options

Vehicle length (m)	Calculate Queue Percentiles	Calculate detailed queueing delay	Show lane queues in feet / metres	Show all PICADY stream intercepts	Calculate residual capacity	RFC Threshold	Average Delay threshold (s)	Queue threshold (PCU)	Use iterations with HCM roundabouts	Max number of iterations for roundabouts
5.75						0.85	36.00	20.00		500

Demand Set Summary

ID	Scenario name	Time Period name	Traffic profile type	Start time (HH:mm)	Finish time (HH:mm)	Time segment length (min)	Run automatically
D1	2022	AM	ONE HOUR	08:00	09:30	15	✓
D2	2022	PM	ONE HOUR	17:00	18:30	15	✓
D3	2027	AM	ONE HOUR	08:00	09:30	15	✓
D4	2027	PM	ONE HOUR	17:00	18:30	15	✓
D5	2027 + Dev	AM	ONE HOUR	08:00	09:30	15	✓
D6	2027 + Dev	PM	ONE HOUR	17:00	18:30	15	✓

Analysis Set Details

ID	Include in report	Network flow scaling factor (%)	Network capacity scaling factor (%)
A1	✓	100.000	100.000

2022, AM

Data Errors and Warnings

Severity	Area	Item	Description
Warning	Minor arm visibility to right	B - Swanland Road - Minor arm geometry	Visibility to right expected to have two components if the arm has two lanes, or two lanes in a flared section.

Junction Network

Junctions

Junction	Name	Junction type	Arm A Direction	Arm B Direction	Arm C Direction	Use circulating lanes	Junction Delay (s)	Junction LOS
1	untitled	T-Junction	Two-way	Two-way	Two-way		4.03	A

Junction Network

Driving side	Lighting	Network delay (s)	Network LOS
Left	Normal/unknown	4.03	A

Arms

Arms

Arm	Name	Description	Arm type
A	Dixons Hill Road (E)		Major
B	Swanland Road		Minor
C	Dixons Hill Road (W)		Major

Major Arm Geometry

Arm	Width of carriageway (m)	Has kerbed central reserve	Has right-turn storage	Visibility for right turn (m)	Blocks?	Blocking queue (PCU)
C - Dixons Hill Road (W)	6.50			138.2	✓	0.00

Geometries for Arm C are measured opposite Arm B. Geometries for Arm A (if relevant) are measured opposite Arm D.

Minor Arm Geometry

Arm	Minor arm type	Width at give-way (m)	Width at 5m (m)	Width at 10m (m)	Width at 15m (m)	Width at 20m (m)	Estimate flare length	Flare length (PCU)	Visibility to left (m)	Visibility to right (m)
B - Swanland Road	One lane plus flare	10.00	7.00	4.30	4.00	3.90	✓	1.00	31	0

Slope / Intercept / Capacity

Priority Intersection Slopes and Intercepts

Stream	Intercept (Veh/hr)	Slope for A-B	Slope for A-C	Slope for C-A	Slope for C-B
B-A	558	0.099	0.251	0.158	0.359
B-C	655	0.098	0.248	-	-
C-B	654	0.248	0.248	-	-

The slopes and intercepts shown above include custom intercept adjustments only.

Streams may be combined, in which case capacity will be adjusted.

Values are shown for the first time segment only; they may differ for subsequent time segments.

Traffic Demand

Demand Set Details

ID	Scenario name	Time Period name	Traffic profile type	Start time (HH:mm)	Finish time (HH:mm)	Time segment length (min)	Run automatically
D1	2022	AM	ONE HOUR	08:00	09:30	15	✓

Vehicle mix varies over turn	Vehicle mix varies over entry	Vehicle mix source	PCU Factor for a HV (PCU)
✓	✓	HV Percentages	2.00

Demand overview (Traffic)

Arm	Linked arm	Profile type	Use O-D data	Average Demand (Veh/hr)	Scaling Factor (%)
A - Dixons Hill Road (E)		ONE HOUR	✓	592	100.000
B - Swanland Road		ONE HOUR	✓	213	100.000
C - Dixons Hill Road (W)		ONE HOUR	✓	271	100.000

Origin-Destination Data

Demand (Veh/hr)

		To		
		A - Dixons Hill Road (E)	B - Swanland Road	C - Dixons Hill Road (W)
From	A - Dixons Hill Road (E)	0	220	372
	B - Swanland Road	151	0	62
	C - Dixons Hill Road (W)	206	65	0

Vehicle Mix

Heavy Vehicle Percentages

		To		
		A - Dixons Hill Road (E)	B - Swanland Road	C - Dixons Hill Road (W)
From	A - Dixons Hill Road (E)	0	3	1
	B - Swanland Road	3	0	0
	C - Dixons Hill Road (W)	1	11	0

Results

Results Summary for whole modelled period

Stream	Max RFC	Max Delay (s)	Max Queue (Veh)	Max LOS	Average Demand (Veh/hr)	Total Junction Arrivals (Veh)
B-C	0.16	10.26	0.2	B	57	85
B-A	0.47	19.56	0.9	C	139	208
C-AB	0.19	7.25	0.3	A	88	132
C-A					160	241
A-B					202	303
A-C					341	512

Main Results for each time segment

08:00 - 08:15

Stream	Total Demand (Veh/hr)	Junction Arrivals (Veh)	Capacity (Veh/hr)	RFC	Throughput (Veh/hr)	Start queue (Veh)	End queue (Veh)	Delay (s)	Unsignalised level of service
B-C	47	12	519	0.090	46	0.0	0.1	7.602	A
B-A	114	28	412	0.276	112	0.0	0.4	11.938	B
C-AB	66	16	601	0.110	65	0.0	0.2	6.722	A
C-A	138	35			138				
A-B	166	41			166				
A-C	280	70			280				

08:15 - 08:30

Stream	Total Demand (Veh/hr)	Junction Arrivals (Veh)	Capacity (Veh/hr)	RFC	Throughput (Veh/hr)	Start queue (Veh)	End queue (Veh)	Delay (s)	Unsignalised level of service
B-C	56	14	483	0.115	56	0.1	0.1	8.421	A
B-A	136	34	386	0.351	135	0.4	0.5	14.289	B
C-AB	84	21	605	0.140	84	0.2	0.2	6.933	A
C-A	159	40			159				
A-B	198	49			198				
A-C	334	84			334				

08:30 - 08:45

Stream	Total Demand (Veh/hr)	Junction Arrivals (Veh)	Capacity (Veh/hr)	RFC	Throughput (Veh/hr)	Start queue (Veh)	End queue (Veh)	Delay (s)	Unsignalised level of service
B-C	68	17	421	0.162	68	0.1	0.2	10.195	B
B-A	166	42	350	0.475	165	0.5	0.9	19.273	C
C-AB	114	29	612	0.186	114	0.2	0.3	7.251	A
C-A	184	46			184				
A-B	242	61			242				
A-C	410	102			410				

08:45 - 09:00

Stream	Total Demand (Veh/hr)	Junction Arrivals (Veh)	Capacity (Veh/hr)	RFC	Throughput (Veh/hr)	Start queue (Veh)	End queue (Veh)	Delay (s)	Unsignalised level of service
B-C	68	17	419	0.163	68	0.2	0.2	10.256	B
B-A	166	42	350	0.475	166	0.9	0.9	19.562	C
C-AB	114	29	612	0.187	114	0.3	0.3	7.242	A
C-A	184	46			184				
A-B	242	61			242				
A-C	410	102			410				

09:00 - 09:15

Stream	Total Demand (Veh/hr)	Junction Arrivals (Veh)	Capacity (Veh/hr)	RFC	Throughput (Veh/hr)	Start queue (Veh)	End queue (Veh)	Delay (s)	Unsignalised level of service
B-C	56	14	481	0.116	56	0.2	0.1	8.468	A
B-A	136	34	386	0.351	137	0.9	0.6	14.526	B
C-AB	85	21	605	0.140	85	0.3	0.2	6.906	A
C-A	159	40			159				
A-B	198	49			198				
A-C	334	84			334				

09:15 - 09:30

Stream	Total Demand (Veh/hr)	Junction Arrivals (Veh)	Capacity (Veh/hr)	RFC	Throughput (Veh/hr)	Start queue (Veh)	End queue (Veh)	Delay (s)	Unsignalised level of service
B-C	47	12	518	0.090	47	0.1	0.1	7.641	A
B-A	114	28	412	0.276	114	0.6	0.4	12.123	B
C-AB	66	17	601	0.110	66	0.2	0.2	6.723	A
C-A	138	34			138				
A-B	166	41			166				
A-C	280	70			280				

2022, PM

Data Errors and Warnings

Severity	Area	Item	Description
Warning	Minor arm visibility to right	B - Swanland Road - Minor arm geometry	Visibility to right expected to have two components if the arm has two lanes, or two lanes in a flared section.

Junction Network

Junctions

Junction	Name	Junction type	Arm A Direction	Arm B Direction	Arm C Direction	Use circulating lanes	Junction Delay (s)	Junction LOS
1	untitled	T-Junction	Two-way	Two-way	Two-way		4.60	A

Junction Network

Driving side	Lighting	Network delay (s)	Network LOS
Left	Normal/unknown	4.60	A

Traffic Demand

Demand Set Details

ID	Scenario name	Time Period name	Traffic profile type	Start time (HH:mm)	Finish time (HH:mm)	Time segment length (min)	Run automatically
D2	2022	PM	ONE HOUR	17:00	18:30	15	✓

Vehicle mix varies over turn	Vehicle mix varies over entry	Vehicle mix source	PCU Factor for a HV (PCU)
✓	✓	HV Percentages	2.00

Demand overview (Traffic)

Arm	Linked arm	Profile type	Use O-D data	Average Demand (Veh/hr)	Scaling Factor (%)
A - Dixons Hill Road (E)		ONE HOUR	✓	395	100.000
B - Swanland Road		ONE HOUR	✓	239	100.000
C - Dixons Hill Road (W)		ONE HOUR	✓	335	100.000

Origin-Destination Data

Demand (Veh/hr)

		To		
		A - Dixons Hill Road (E)	B - Swanland Road	C - Dixons Hill Road (W)
From	A - Dixons Hill Road (E)	0	158	237
	B - Swanland Road	170	0	69
	C - Dixons Hill Road (W)	271	64	0

Vehicle Mix

Heavy Vehicle Percentages

		To		
		A - Dixons Hill Road (E)	B - Swanland Road	C - Dixons Hill Road (W)
From	A - Dixons Hill Road (E)	0	1	1
	B - Swanland Road	4	0	1
	C - Dixons Hill Road (W)	1	0	0

Results

Results Summary for whole modelled period

Stream	Max RFC	Max Delay (s)	Max Queue (Veh)	Max LOS	Average Demand (Veh/hr)	Total Junction Arrivals (Veh)
B-C	0.17	9.81	0.2	A	63	95
B-A	0.49	18.51	0.9	C	156	234
C-AB	0.16	5.67	0.3	A	90	136
C-A					217	325
A-B					145	217
A-C					217	326

Main Results for each time segment

17:00 - 17:15

Stream	Total Demand (Veh/hr)	Junction Arrivals (Veh)	Capacity (Veh/hr)	RFC	Throughput (Veh/hr)	Start queue (Veh)	End queue (Veh)	Delay (s)	Unsignalised level of service
B-C	52	13	536	0.097	52	0.0	0.1	7.419	A
B-A	128	32	432	0.296	126	0.0	0.4	11.702	B
C-AB	67	17	717	0.094	67	0.0	0.2	5.532	A
C-A	185	46			185				
A-B	119	30			119				
A-C	178	45			178				

17:15 - 17:30

Stream	Total Demand (Veh/hr)	Junction Arrivals (Veh)	Capacity (Veh/hr)	RFC	Throughput (Veh/hr)	Start queue (Veh)	End queue (Veh)	Delay (s)	Unsignalised level of service
B-C	62	16	503	0.123	62	0.1	0.1	8.160	A
B-A	153	38	411	0.372	152	0.4	0.6	13.859	B
C-AB	86	22	732	0.118	86	0.2	0.2	5.581	A
C-A	215	54			215				
A-B	142	36			142				
A-C	213	53			213				

17:30 - 17:45

Stream	Total Demand (Veh/hr)	Junction Arrivals (Veh)	Capacity (Veh/hr)	RFC	Throughput (Veh/hr)	Start queue (Veh)	End queue (Veh)	Delay (s)	Unsignalised level of service
B-C	76	19	445	0.171	76	0.1	0.2	9.748	A
B-A	187	47	381	0.491	186	0.6	0.9	18.258	C
C-AB	117	29	752	0.156	117	0.2	0.3	5.668	A
C-A	252	63			252				
A-B	174	43			174				
A-C	261	65			261				

17:45 - 18:00

Stream	Total Demand (Veh/hr)	Junction Arrivals (Veh)	Capacity (Veh/hr)	RFC	Throughput (Veh/hr)	Start queue (Veh)	End queue (Veh)	Delay (s)	Unsignalised level of service
B-C	76	19	443	0.171	76	0.2	0.2	9.806	A
B-A	187	47	381	0.491	187	0.9	0.9	18.514	C
C-AB	117	29	753	0.156	117	0.3	0.3	5.673	A
C-A	252	63			252				
A-B	174	43			174				
A-C	261	65			261				

18:00 - 18:15

Stream	Total Demand (Veh/hr)	Junction Arrivals (Veh)	Capacity (Veh/hr)	RFC	Throughput (Veh/hr)	Start queue (Veh)	End queue (Veh)	Delay (s)	Unsignalised level of service
B-C	62	16	501	0.124	62	0.2	0.1	8.207	A
B-A	153	38	411	0.372	154	0.9	0.6	14.087	B
C-AB	87	22	732	0.118	87	0.3	0.2	5.592	A
C-A	215	54			215				
A-B	142	36			142				
A-C	213	53			213				

18:15 - 18:30

Stream	Total Demand (Veh/hr)	Junction Arrivals (Veh)	Capacity (Veh/hr)	RFC	Throughput (Veh/hr)	Start queue (Veh)	End queue (Veh)	Delay (s)	Unsignalised level of service
B-C	52	13	535	0.097	52	0.1	0.1	7.460	A
B-A	128	32	432	0.296	129	0.6	0.4	11.897	B
C-AB	68	17	717	0.094	68	0.2	0.2	5.550	A
C-A	185	46			185				
A-B	119	30			119				
A-C	178	45			178				

2027, AM

Data Errors and Warnings

Severity	Area	Item	Description
Warning	Minor arm visibility to right	B - Swanland Road - Minor arm geometry	Visibility to right expected to have two components if the arm has two lanes, or two lanes in a flared section.

Junction Network

Junctions

Junction	Name	Junction type	Arm A Direction	Arm B Direction	Arm C Direction	Use circulating lanes	Junction Delay (s)	Junction LOS
1	untitled	T-Junction	Two-way	Two-way	Two-way		4.12	A

Junction Network

Driving side	Lighting	Network delay (s)	Network LOS
Left	Normal/unknown	4.12	A

Traffic Demand

Demand Set Details

ID	Scenario name	Time Period name	Traffic profile type	Start time (HH:mm)	Finish time (HH:mm)	Time segment length (min)	Run automatically
D3	2027	AM	ONE HOUR	08:00	09:30	15	✓

Vehicle mix varies over turn	Vehicle mix varies over entry	Vehicle mix source	PCU Factor for a HV (PCU)
✓	✓	HV Percentages	2.00

Demand overview (Traffic)

Arm	Linked arm	Profile type	Use O-D data	Average Demand (Veh/hr)	Scaling Factor (%)
A - Dixons Hill Road (E)		ONE HOUR	✓	601	100.000
B - Swanland Road		ONE HOUR	✓	216	100.000
C - Dixons Hill Road (W)		ONE HOUR	✓	275	100.000

Origin-Destination Data

Demand (Veh/hr)

		To		
		A - Dixons Hill Road (E)	B - Swanland Road	C - Dixons Hill Road (W)
From	A - Dixons Hill Road (E)	0	223	378
	B - Swanland Road	153	0	63
	C - Dixons Hill Road (W)	209	66	0

Vehicle Mix

Heavy Vehicle Percentages

		To		
		A - Dixons Hill Road (E)	B - Swanland Road	C - Dixons Hill Road (W)
From	A - Dixons Hill Road (E)	0	3	1
	B - Swanland Road	3	0	0
	C - Dixons Hill Road (W)	1	11	0

Results

Results Summary for whole modelled period

Stream	Max RFC	Max Delay (s)	Max Queue (Veh)	Max LOS	Average Demand (Veh/hr)	Total Junction Arrivals (Veh)
B-C	0.17	10.47	0.2	B	58	87
B-A	0.49	20.12	0.9	C	140	211
C-AB	0.19	7.28	0.3	A	90	135
C-A					162	243
A-B					205	307
A-C					347	520

Main Results for each time segment

08:00 - 08:15

Stream	Total Demand (Veh/hr)	Junction Arrivals (Veh)	Capacity (Veh/hr)	RFC	Throughput (Veh/hr)	Start queue (Veh)	End queue (Veh)	Delay (s)	Unsignalised level of service
B-C	47	12	517	0.092	47	0.0	0.1	7.655	A
B-A	115	29	410	0.281	114	0.0	0.4	12.076	B
C-AB	67	17	601	0.112	67	0.0	0.2	6.736	A
C-A	140	35			140				
A-B	168	42			168				
A-C	285	71			285				

08:15 - 08:30

Stream	Total Demand (Veh/hr)	Junction Arrivals (Veh)	Capacity (Veh/hr)	RFC	Throughput (Veh/hr)	Start queue (Veh)	End queue (Veh)	Delay (s)	Unsignalised level of service
B-C	57	14	479	0.118	57	0.1	0.1	8.508	A
B-A	138	34	384	0.358	137	0.4	0.5	14.528	B
C-AB	86	22	605	0.143	86	0.2	0.2	6.951	A
C-A	161	40			161				
A-B	200	50			200				
A-C	340	85			340				

08:30 - 08:45

Stream	Total Demand (Veh/hr)	Junction Arrivals (Veh)	Capacity (Veh/hr)	RFC	Throughput (Veh/hr)	Start queue (Veh)	End queue (Veh)	Delay (s)	Unsignalised level of service
B-C	69	17	415	0.167	69	0.1	0.2	10.398	B
B-A	168	42	347	0.485	167	0.5	0.9	19.826	C
C-AB	117	29	613	0.191	116	0.2	0.3	7.283	A
C-A	186	46			186				
A-B	246	61			246				
A-C	416	104			416				

08:45 - 09:00

Stream	Total Demand (Veh/hr)	Junction Arrivals (Veh)	Capacity (Veh/hr)	RFC	Throughput (Veh/hr)	Start queue (Veh)	End queue (Veh)	Delay (s)	Unsignalised level of service
B-C	69	17	413	0.168	69	0.2	0.2	10.465	B
B-A	168	42	347	0.486	168	0.9	0.9	20.125	C
C-AB	117	29	613	0.191	117	0.3	0.3	7.274	A
C-A	186	46			186				
A-B	246	61			246				
A-C	416	104			416				

09:00 - 09:15

Stream	Total Demand (Veh/hr)	Junction Arrivals (Veh)	Capacity (Veh/hr)	RFC	Throughput (Veh/hr)	Start queue (Veh)	End queue (Veh)	Delay (s)	Unsignalised level of service
B-C	57	14	478	0.119	57	0.2	0.1	8.561	A
B-A	138	34	384	0.358	139	0.9	0.6	14.790	B
C-AB	86	22	606	0.143	87	0.3	0.2	6.923	A
C-A	161	40			161				
A-B	200	50			200				
A-C	340	85			340				

09:15 - 09:30

Stream	Total Demand (Veh/hr)	Junction Arrivals (Veh)	Capacity (Veh/hr)	RFC	Throughput (Veh/hr)	Start queue (Veh)	End queue (Veh)	Delay (s)	Unsignalised level of service
B-C	47	12	515	0.092	48	0.1	0.1	7.697	A
B-A	115	29	410	0.281	116	0.6	0.4	12.269	B
C-AB	68	17	601	0.112	68	0.2	0.2	6.740	A
C-A	139	35			139				
A-B	168	42			168				
A-C	285	71			285				

2027, PM

Data Errors and Warnings

Severity	Area	Item	Description
Warning	Minor arm visibility to right	B - Swanland Road - Minor arm geometry	Visibility to right expected to have two components if the arm has two lanes, or two lanes in a flared section.

Junction Network

Junctions

Junction	Name	Junction type	Arm A Direction	Arm B Direction	Arm C Direction	Use circulating lanes	Junction Delay (s)	Junction LOS
1	untitled	T-Junction	Two-way	Two-way	Two-way		4.73	A

Junction Network

Driving side	Lighting	Network delay (s)	Network LOS
Left	Normal/unknown	4.73	A

Traffic Demand

Demand Set Details

ID	Scenario name	Time Period name	Traffic profile type	Start time (HH:mm)	Finish time (HH:mm)	Time segment length (min)	Run automatically
D4	2027	PM	ONE HOUR	17:00	18:30	15	✓

Vehicle mix varies over turn	Vehicle mix varies over entry	Vehicle mix source	PCU Factor for a HV (PCU)
✓	✓	HV Percentages	2.00

Demand overview (Traffic)

Arm	Linked arm	Profile type	Use O-D data	Average Demand (Veh/hr)	Scaling Factor (%)
A - Dixons Hill Road (E)		ONE HOUR	✓	402	100.000
B - Swanland Road		ONE HOUR	✓	243	100.000
C - Dixons Hill Road (W)		ONE HOUR	✓	340	100.000

Origin-Destination Data

Demand (Veh/hr)

		To		
		A - Dixons Hill Road (E)	B - Swanland Road	C - Dixons Hill Road (W)
From	A - Dixons Hill Road (E)	0	161	241
	B - Swanland Road	173	0	70
	C - Dixons Hill Road (W)	275	65	0

Vehicle Mix

Heavy Vehicle Percentages

		To		
		A - Dixons Hill Road (E)	B - Swanland Road	C - Dixons Hill Road (W)
From	A - Dixons Hill Road (E)	0	1	1
	B - Swanland Road	4	0	1
	C - Dixons Hill Road (W)	1	0	0

Results

Results Summary for whole modelled period

Stream	Max RFC	Max Delay (s)	Max Queue (Veh)	Max LOS	Average Demand (Veh/hr)	Total Junction Arrivals (Veh)
B-C	0.18	10.02	0.2	B	64	96
B-A	0.50	19.12	1.0	C	159	238
C-AB	0.16	5.69	0.3	A	92	139
C-A					220	329
A-B					148	222
A-C					221	332

Main Results for each time segment

17:00 - 17:15

Stream	Total Demand (Veh/hr)	Junction Arrivals (Veh)	Capacity (Veh/hr)	RFC	Throughput (Veh/hr)	Start queue (Veh)	End queue (Veh)	Delay (s)	Unsignalised level of service
B-C	53	13	534	0.099	52	0.0	0.1	7.472	A
B-A	130	33	431	0.302	129	0.0	0.4	11.854	B
C-AB	69	17	718	0.096	68	0.0	0.2	5.537	A
C-A	187	47			187				
A-B	121	30			121				
A-C	181	45			181				

17:15 - 17:30

Stream	Total Demand (Veh/hr)	Junction Arrivals (Veh)	Capacity (Veh/hr)	RFC	Throughput (Veh/hr)	Start queue (Veh)	End queue (Veh)	Delay (s)	Unsignalised level of service
B-C	63	16	499	0.126	63	0.1	0.1	8.249	A
B-A	156	39	409	0.380	155	0.4	0.6	14.116	B
C-AB	88	22	733	0.121	88	0.2	0.2	5.586	A
C-A	217	54			217				
A-B	145	36			145				
A-C	217	54			217				

17:30 - 17:45

Stream	Total Demand (Veh/hr)	Junction Arrivals (Veh)	Capacity (Veh/hr)	RFC	Throughput (Veh/hr)	Start queue (Veh)	End queue (Veh)	Delay (s)	Unsignalised level of service
B-C	77	19	438	0.176	77	0.1	0.2	9.954	A
B-A	190	48	379	0.503	189	0.6	1.0	18.814	C
C-AB	120	30	754	0.159	120	0.2	0.3	5.678	A
C-A	254	64			254				
A-B	177	44			177				
A-C	265	66			265				

17:45 - 18:00

Stream	Total Demand (Veh/hr)	Junction Arrivals (Veh)	Capacity (Veh/hr)	RFC	Throughput (Veh/hr)	Start queue (Veh)	End queue (Veh)	Delay (s)	Unsignalised level of service
B-C	77	19	436	0.177	77	0.2	0.2	10.018	B
B-A	190	48	379	0.503	190	1.0	1.0	19.119	C
C-AB	120	30	754	0.159	120	0.3	0.3	5.688	A
C-A	254	64			254				
A-B	177	44			177				
A-C	265	66			265				

18:00 - 18:15

Stream	Total Demand (Veh/hr)	Junction Arrivals (Veh)	Capacity (Veh/hr)	RFC	Throughput (Veh/hr)	Start queue (Veh)	End queue (Veh)	Delay (s)	Unsignalised level of service
B-C	63	16	497	0.127	63	0.2	0.1	8.303	A
B-A	156	39	409	0.380	157	1.0	0.6	14.371	B
C-AB	89	22	733	0.121	89	0.3	0.2	5.602	A
C-A	217	54			217				
A-B	145	36			145				
A-C	217	54			217				

18:15 - 18:30

Stream	Total Demand (Veh/hr)	Junction Arrivals (Veh)	Capacity (Veh/hr)	RFC	Throughput (Veh/hr)	Start queue (Veh)	End queue (Veh)	Delay (s)	Unsignalised level of service
B-C	53	13	532	0.099	53	0.1	0.1	7.514	A
B-A	130	33	430	0.303	131	0.6	0.4	12.059	B
C-AB	69	17	718	0.096	69	0.2	0.2	5.552	A
C-A	187	47			187				
A-B	121	30			121				
A-C	181	45			181				

2027 + Dev, AM

Data Errors and Warnings

Severity	Area	Item	Description
Warning	Minor arm visibility to right	B - Swanland Road - Minor arm geometry	Visibility to right expected to have two components if the arm has two lanes, or two lanes in a flared section.

Junction Network

Junctions

Junction	Name	Junction type	Arm A Direction	Arm B Direction	Arm C Direction	Use circulating lanes	Junction Delay (s)	Junction LOS
1	untitled	T-Junction	Two-way	Two-way	Two-way		4.23	A

Junction Network

Driving side	Lighting	Network delay (s)	Network LOS
Left	Normal/unknown	4.23	A

Traffic Demand

Demand Set Details

ID	Scenario name	Time Period name	Traffic profile type	Start time (HH:mm)	Finish time (HH:mm)	Time segment length (min)	Run automatically
D5	2027 + Dev	AM	ONE HOUR	08:00	09:30	15	✓

Vehicle mix varies over turn	Vehicle mix varies over entry	Vehicle mix source	PCU Factor for a HV (PCU)
✓	✓	HV Percentages	2.00

Demand overview (Traffic)

Arm	Linked arm	Profile type	Use O-D data	Average Demand (Veh/hr)	Scaling Factor (%)
A - Dixons Hill Road (E)		ONE HOUR	✓	605	100.000
B - Swanland Road		ONE HOUR	✓	218	100.000
C - Dixons Hill Road (W)		ONE HOUR	✓	290	100.000

Origin-Destination Data

Demand (Veh/hr)

		To		
		A - Dixons Hill Road (E)	B - Swanland Road	C - Dixons Hill Road (W)
From	A - Dixons Hill Road (E)	0	223	382
	B - Swanland Road	153	0	65
	C - Dixons Hill Road (W)	219	71	0

Vehicle Mix

Heavy Vehicle Percentages

		To		
		A - Dixons Hill Road (E)	B - Swanland Road	C - Dixons Hill Road (W)
From	A - Dixons Hill Road (E)	0	3	1
	B - Swanland Road	3	0	0
	C - Dixons Hill Road (W)	1	11	0

Results

Results Summary for whole modelled period

Stream	Max RFC	Max Delay (s)	Max Queue (Veh)	Max LOS	Average Demand (Veh/hr)	Total Junction Arrivals (Veh)
B-C	0.17	10.64	0.2	B	60	89
B-A	0.49	20.76	1.0	C	140	211
C-AB	0.21	7.35	0.4	A	99	148
C-A					167	251
A-B					205	307
A-C					351	526

Main Results for each time segment

08:00 - 08:15

Stream	Total Demand (Veh/hr)	Junction Arrivals (Veh)	Capacity (Veh/hr)	RFC	Throughput (Veh/hr)	Start queue (Veh)	End queue (Veh)	Delay (s)	Unsignalised level of service
B-C	49	12	517	0.095	49	0.0	0.1	7.684	A
B-A	115	29	407	0.283	114	0.0	0.4	12.228	B
C-AB	73	18	606	0.121	73	0.0	0.2	6.750	A
C-A	145	36			145				
A-B	168	42			168				
A-C	288	72			288				

08:15 - 08:30

Stream	Total Demand (Veh/hr)	Junction Arrivals (Veh)	Capacity (Veh/hr)	RFC	Throughput (Veh/hr)	Start queue (Veh)	End queue (Veh)	Delay (s)	Unsignalised level of service
B-C	58	15	478	0.122	58	0.1	0.1	8.569	A
B-A	138	34	380	0.362	137	0.4	0.6	14.789	B
C-AB	94	24	611	0.154	94	0.2	0.3	6.981	A
C-A	166	42			166				
A-B	200	50			200				
A-C	343	86			343				

08:30 - 08:45

Stream	Total Demand (Veh/hr)	Junction Arrivals (Veh)	Capacity (Veh/hr)	RFC	Throughput (Veh/hr)	Start queue (Veh)	End queue (Veh)	Delay (s)	Unsignalised level of service
B-C	72	18	412	0.174	71	0.1	0.2	10.561	B
B-A	168	42	342	0.493	167	0.6	0.9	20.418	C
C-AB	128	32	620	0.207	128	0.3	0.4	7.345	A
C-A	191	48			191				
A-B	246	61			246				
A-C	421	105			421				

08:45 - 09:00

Stream	Total Demand (Veh/hr)	Junction Arrivals (Veh)	Capacity (Veh/hr)	RFC	Throughput (Veh/hr)	Start queue (Veh)	End queue (Veh)	Delay (s)	Unsignalised level of service
B-C	72	18	410	0.175	72	0.2	0.2	10.641	B
B-A	168	42	342	0.493	168	0.9	1.0	20.765	C
C-AB	129	32	620	0.207	129	0.4	0.4	7.334	A
C-A	191	48			191				
A-B	246	61			246				
A-C	421	105			421				

09:00 - 09:15

Stream	Total Demand (Veh/hr)	Junction Arrivals (Veh)	Capacity (Veh/hr)	RFC	Throughput (Veh/hr)	Start queue (Veh)	End queue (Veh)	Delay (s)	Unsignalised level of service
B-C	58	15	476	0.123	59	0.2	0.1	8.629	A
B-A	138	34	379	0.363	139	1.0	0.6	15.067	C
C-AB	95	24	612	0.155	95	0.4	0.3	6.954	A
C-A	166	42			166				
A-B	200	50			200				
A-C	343	86			343				

09:15 - 09:30

Stream	Total Demand (Veh/hr)	Junction Arrivals (Veh)	Capacity (Veh/hr)	RFC	Throughput (Veh/hr)	Start queue (Veh)	End queue (Veh)	Delay (s)	Unsignalised level of service
B-C	49	12	515	0.095	49	0.1	0.1	7.730	A
B-A	115	29	406	0.284	116	0.6	0.4	12.429	B
C-AB	74	18	606	0.122	74	0.3	0.2	6.756	A
C-A	145	36			145				
A-B	168	42			168				
A-C	288	72			288				

2027 + Dev, PM

Data Errors and Warnings

Severity	Area	Item	Description
Warning	Minor arm visibility to right	B - Swanland Road - Minor arm geometry	Visibility to right expected to have two components if the arm has two lanes, or two lanes in a flared section.

Junction Network

Junctions

Junction	Name	Junction type	Arm A Direction	Arm B Direction	Arm C Direction	Use circulating lanes	Junction Delay (s)	Junction LOS
1	untitled	T-Junction	Two-way	Two-way	Two-way		4.83	A

Junction Network

Driving side	Lighting	Network delay (s)	Network LOS
Left	Normal/unknown	4.83	A

Traffic Demand

Demand Set Details

ID	Scenario name	Time Period name	Traffic profile type	Start time (HH:mm)	Finish time (HH:mm)	Time segment length (min)	Run automatically
D6	2027 + Dev	PM	ONE HOUR	17:00	18:30	15	✓

Vehicle mix varies over turn	Vehicle mix varies over entry	Vehicle mix source	PCU Factor for a HV (PCU)
✓	✓	HV Percentages	2.00

Demand overview (Traffic)

Arm	Linked arm	Profile type	Use O-D data	Average Demand (Veh/hr)	Scaling Factor (%)
A - Dixons Hill Road (E)		ONE HOUR	✓	411	100.000
B - Swanland Road		ONE HOUR	✓	248	100.000
C - Dixons Hill Road (W)		ONE HOUR	✓	349	100.000

Origin-Destination Data

Demand (Veh/hr)

		To		
		A - Dixons Hill Road (E)	B - Swanland Road	C - Dixons Hill Road (W)
From	A - Dixons Hill Road (E)	0	161	250
	B - Swanland Road	173	0	75
	C - Dixons Hill Road (W)	281	68	0

Vehicle Mix

Heavy Vehicle Percentages

		To		
		A - Dixons Hill Road (E)	B - Swanland Road	C - Dixons Hill Road (W)
From	A - Dixons Hill Road (E)	0	1	1
	B - Swanland Road	4	0	1
	C - Dixons Hill Road (W)	1	0	0

Results

Results Summary for whole modelled period

Stream	Max RFC	Max Delay (s)	Max Queue (Veh)	Max LOS	Average Demand (Veh/hr)	Total Junction Arrivals (Veh)
B-C	0.19	10.29	0.2	B	69	103
B-A	0.51	19.69	1.0	C	159	238
C-AB	0.17	5.73	0.3	A	98	147
C-A					222	334
A-B					148	222
A-C					229	344

Main Results for each time segment

17:00 - 17:15

Stream	Total Demand (Veh/hr)	Junction Arrivals (Veh)	Capacity (Veh/hr)	RFC	Throughput (Veh/hr)	Start queue (Veh)	End queue (Veh)	Delay (s)	Unsignalised level of service
B-C	56	14	533	0.106	56	0.0	0.1	7.536	A
B-A	130	33	427	0.305	129	0.0	0.4	12.005	B
C-AB	73	18	720	0.101	72	0.0	0.2	5.555	A
C-A	190	48			190				
A-B	121	30			121				
A-C	188	47			188				

17:15 - 17:30

Stream	Total Demand (Veh/hr)	Junction Arrivals (Veh)	Capacity (Veh/hr)	RFC	Throughput (Veh/hr)	Start queue (Veh)	End queue (Veh)	Delay (s)	Unsignalised level of service
B-C	67	17	498	0.136	67	0.1	0.2	8.365	A
B-A	156	39	405	0.384	155	0.4	0.6	14.368	B
C-AB	93	23	735	0.127	93	0.2	0.2	5.613	A
C-A	220	55			220				
A-B	145	36			145				
A-C	225	56			225				

17:30 - 17:45

Stream	Total Demand (Veh/hr)	Junction Arrivals (Veh)	Capacity (Veh/hr)	RFC	Throughput (Veh/hr)	Start queue (Veh)	End queue (Veh)	Delay (s)	Unsignalised level of service
B-C	83	21	435	0.190	82	0.2	0.2	10.212	B
B-A	190	48	373	0.511	189	0.6	1.0	19.375	C
C-AB	127	32	756	0.168	127	0.2	0.3	5.721	A
C-A	257	64			257				
A-B	177	44			177				
A-C	275	69			275				

17:45 - 18:00

Stream	Total Demand (Veh/hr)	Junction Arrivals (Veh)	Capacity (Veh/hr)	RFC	Throughput (Veh/hr)	Start queue (Veh)	End queue (Veh)	Delay (s)	Unsignalised level of service
B-C	83	21	432	0.191	83	0.2	0.2	10.290	B
B-A	190	48	373	0.511	190	1.0	1.0	19.695	C
C-AB	127	32	757	0.168	127	0.3	0.3	5.730	A
C-A	257	64			257				
A-B	177	44			177				
A-C	275	69			275				

18:00 - 18:15

Stream	Total Demand (Veh/hr)	Junction Arrivals (Veh)	Capacity (Veh/hr)	RFC	Throughput (Veh/hr)	Start queue (Veh)	End queue (Veh)	Delay (s)	Unsignalised level of service
B-C	67	17	495	0.136	68	0.2	0.2	8.427	A
B-A	156	39	404	0.385	157	1.0	0.6	14.641	B
C-AB	94	23	735	0.127	94	0.3	0.2	5.627	A
C-A	220	55			220				
A-B	145	36			145				
A-C	225	56			225				

18:15 - 18:30

Stream	Total Demand (Veh/hr)	Junction Arrivals (Veh)	Capacity (Veh/hr)	RFC	Throughput (Veh/hr)	Start queue (Veh)	End queue (Veh)	Delay (s)	Unsignalised level of service
B-C	56	14	531	0.106	57	0.2	0.1	7.586	A
B-A	130	33	427	0.305	131	0.6	0.4	12.213	B
C-AB	73	18	720	0.101	73	0.2	0.2	5.572	A
C-A	190	47			190				
A-B	121	30			121				
A-C	188	47			188				

Junctions 10
ARCADY 10 - Roundabout Module
Version: 10.0.3.1598 © Copyright TRL Software Limited, 2021
For sales and distribution information, program advice and maintenance, contact TRL Software: +44 (0)1344 379777 software@trl.co.uk trlsoftware.com
The users of this computer program for the solution of an engineering problem are in no way relieved of their responsibility for the correctness of the solution

Filename: Roestock Lane.High Street.Tollgate Road.Coursers Road Roundabout.j10
Path: P:\JNY11289 - Colney Heath\Transport\Arcady
Report generation date: 27/04/2022 11:07:01

- »2022, AM
- »2022, PM
- »2027, AM
- »2027, PM
- »2027 + Dev, AM
- »2027 + Dev, PM

Summary of junction performance

	AM					PM				
	Set ID	Queue (Veh)	Delay (s)	RFC	LOS	Set ID	Queue (Veh)	Delay (s)	RFC	LOS
2022										
1 - Roestock Lane	D1	0.2	6.02	0.17	A	D2	0.1	5.76	0.10	A
2 - Tollgate Road		1.5	10.69	0.60	B		0.6	6.79	0.39	A
3 - Coursers Road		0.8	8.14	0.44	A		1.2	8.98	0.55	A
4 - High Street		0.4	4.22	0.29	A		0.5	4.48	0.34	A
2027										
1 - Roestock Lane	D3	0.2	6.07	0.17	A	D4	0.1	5.81	0.10	A
2 - Tollgate Road		1.6	11.11	0.62	B		0.6	6.87	0.39	A
3 - Coursers Road		0.8	8.38	0.45	A		1.3	9.20	0.56	A
4 - High Street		0.4	4.25	0.30	A		0.5	4.53	0.34	A
2027 + Dev										
1 - Roestock Lane	D5	0.2	6.14	0.17	A	D6	0.1	5.96	0.11	A
2 - Tollgate Road		1.9	12.46	0.66	B		0.7	7.14	0.42	A
3 - Coursers Road		0.9	8.70	0.47	A		1.4	9.69	0.58	A
4 - High Street		0.4	4.32	0.31	A		0.6	4.70	0.36	A

Values shown are the highest values encountered over all time segments. Delay is the maximum value of average delay per arriving vehicle.

File summary

File Description

Title	
Location	
Site number	
Date	17/02/2022
Version	
Status	(new file)
Identifier	
Client	
Jobnumber	
Enumerator	EUR\Danesh.Aryan
Description	

Units

Distance units	Speed units	Traffic units input	Traffic units results	Flow units	Average delay units	Total delay units	Rate of delay units
m	kph	Veh	Veh	perHour	s	-Min	perMin

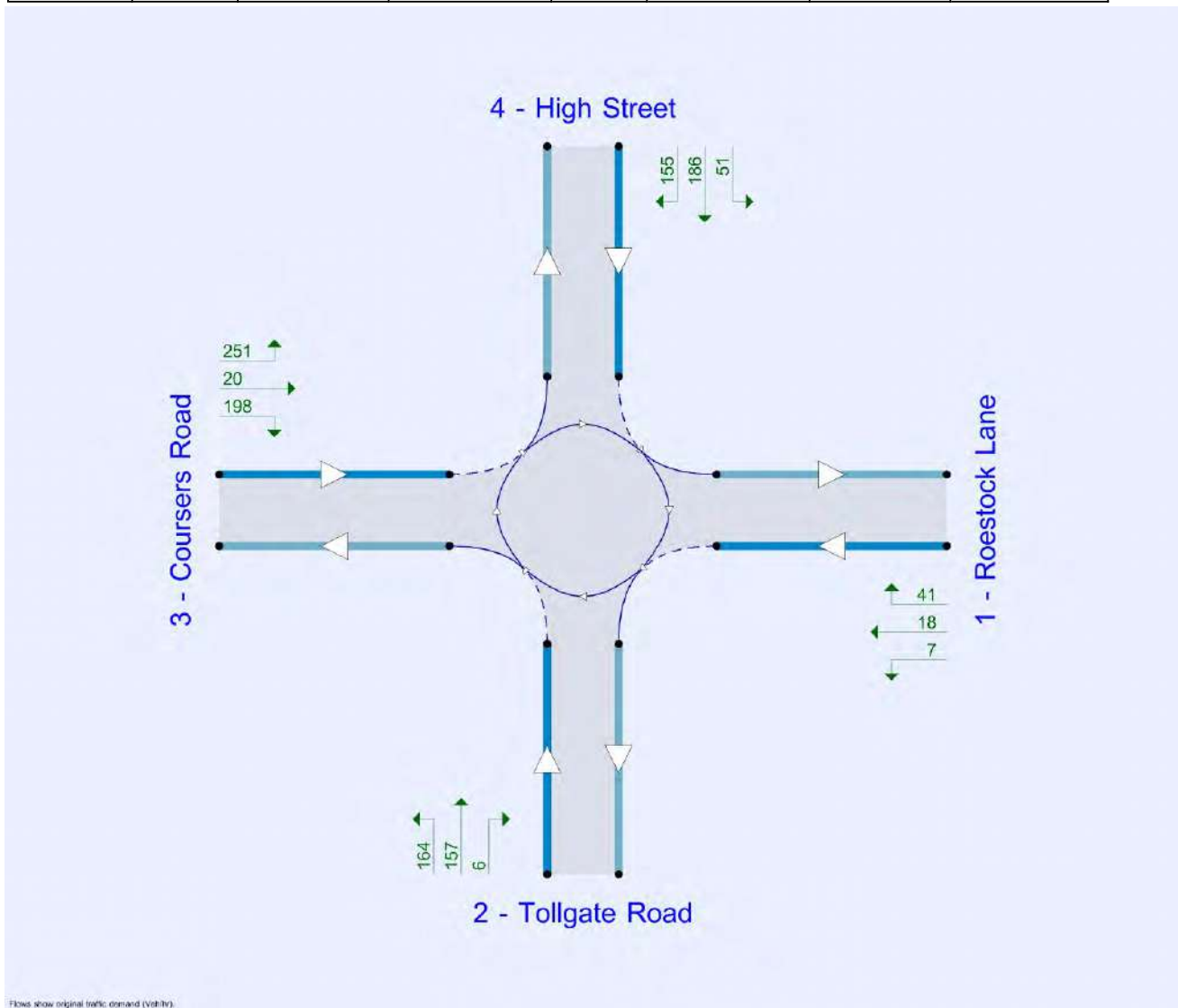

Analysis Options

Vehicle length (m)	Calculate Queue Percentiles	Calculate detailed queueing delay	Show lane queues in feet / metres	Show all PICADY stream intercepts	Calculate residual capacity	RFC Threshold	Average Delay threshold (s)	Queue threshold (PCU)	Use iterations with HCM roundabouts	Max number of iterations for roundabouts
5.75						0.85	36.00	20.00		500

Demand Set Summary

ID	Scenario name	Time Period name	Traffic profile type	Start time (HH:mm)	Finish time (HH:mm)	Time segment length (min)	Run automatically
D1	2022	AM	ONE HOUR	08:00	09:30	15	✓
D2	2022	PM	ONE HOUR	17:00	18:30	15	✓
D3	2027	AM	ONE HOUR	08:00	09:30	15	✓
D4	2027	PM	ONE HOUR	17:00	18:30	15	✓
D5	2027 + Dev	AM	ONE HOUR	08:00	09:30	15	✓
D6	2027 + Dev	PM	ONE HOUR	17:00	18:30	15	✓

Analysis Set Details

ID	Include in report	Network flow scaling factor (%)	Network capacity scaling factor (%)
A1	✓	100.000	100.000

2022, AM

Data Errors and Warnings

No errors or warnings

Junction Network

Junctions

Junction	Name	Junction type	Use circulating lanes	Arm order	Junction Delay (s)	Junction LOS
1	untitled	Standard Roundabout		1, 2, 3, 4	7.85	A

Junction Network

Driving side	Lighting	Network delay (s)	Network LOS
Left	Normal/unknown	7.85	A

Arms

Arms

Arm	Name	Description	No give-way line
1	Roestock Lane		
2	Tollgate Road		
3	Coursers Road		
4	High Street		

Roundabout Geometry

Arm	V - Approach road half-width (m)	E - Entry width (m)	I' - Effective flare length (m)	R - Entry radius (m)	D - Inscribed circle diameter (m)	PHI - Conflict (entry) angle (deg)	Entry only	Exit only
1 - Roestock Lane	2.70	5.00	5.6	12.7	20.6	64.0		
2 - Tollgate Road	3.10	3.80	1.9	25.0	20.6	45.0		
3 - Coursers Road	2.80	4.20	6.5	11.1	20.6	42.0		
4 - High Street	3.10	4.60	16.4	26.7	20.6	18.0		

Slope / Intercept / Capacity

Roundabout Slope and Intercept used in model

Arm	Final slope	Final intercept (PCU/hr)
1 - Roestock Lane	0.465	956
2 - Tollgate Road	0.505	993
3 - Coursers Road	0.496	1011
4 - High Street	0.611	1360

The slope and intercept shown above include any corrections and adjustments.

Traffic Demand

Demand Set Details

ID	Scenario name	Time Period name	Traffic profile type	Start time (HH:mm)	Finish time (HH:mm)	Time segment length (min)	Run automatically
D1	2022	AM	ONE HOUR	08:00	09:30	15	✓

Vehicle mix varies over turn	Vehicle mix varies over entry	Vehicle mix source	PCU Factor for a HV (PCU)
✓	✓	HV Percentages	2.00

Demand overview (Traffic)

Arm	Linked arm	Profile type	Use O-D data	Average Demand (Veh/hr)	Scaling Factor (%)
1 - Roestock Lane		ONE HOUR	✓	111	100.000
2 - Tollgate Road		ONE HOUR	✓	463	100.000
3 - Coursers Road		ONE HOUR	✓	319	100.000
4 - High Street		ONE HOUR	✓	322	100.000

Origin-Destination Data

Demand (Veh/hr)

		To			
		1 - Roestock Lane	2 - Tollgate Road	3 - Coursers Road	4 - High Street
From	1 - Roestock Lane	0	7	17	87
	2 - Tollgate Road	1	0	203	259
	3 - Coursers Road	15	124	1	179
	4 - High Street	35	159	127	1

Vehicle Mix

Heavy Vehicle Percentages

		To			
		1 - Roestock Lane	2 - Tollgate Road	3 - Coursers Road	4 - High Street
From	1 - Roestock Lane	0	14	0	2
	2 - Tollgate Road	0	0	1	2
	3 - Coursers Road	7	1	0	4
	4 - High Street	6	5	4	0

Results

Results Summary for whole modelled period

Arm	Max RFC	Max Delay (s)	Max Queue (Veh)	Max LOS	Average Demand (Veh/hr)	Total Junction Arrivals (Veh)
1 - Roestock Lane	0.17	6.02	0.2	A	102	153
2 - Tollgate Road	0.60	10.69	1.5	B	425	637
3 - Coursers Road	0.44	8.14	0.8	A	293	439
4 - High Street	0.29	4.22	0.4	A	295	443

Main Results for each time segment

08:00 - 08:15

Arm	Total Demand (Veh/hr)	Junction Arrivals (Veh)	Circulating flow (Veh/hr)	Capacity (Veh/hr)	RFC	Throughput (Veh/hr)	Throughput (exit side) (Veh/hr)	Start queue (Veh)	End queue (Veh)	Delay (s)	Unsignalised level of service
1 - Roestock Lane	84	21	309	788	0.106	83	38	0.0	0.1	5.104	A
2 - Tollgate Road	349	87	175	888	0.392	346	217	0.0	0.6	6.609	A
3 - Coursers Road	240	60	260	854	0.281	239	260	0.0	0.4	5.840	A
4 - High Street	242	61	105	1237	0.196	241	393	0.0	0.2	3.613	A

08:15 - 08:30

Arm	Total Demand (Veh/hr)	Junction Arrivals (Veh)	Circulating flow (Veh/hr)	Capacity (Veh/hr)	RFC	Throughput (Veh/hr)	Throughput (exit side) (Veh/hr)	Start queue (Veh)	End queue (Veh)	Delay (s)	Unsignalised level of service
1 - Roestock Lane	100	25	370	759	0.131	100	46	0.1	0.2	5.456	A
2 - Tollgate Road	416	104	209	871	0.478	415	260	0.6	0.9	7.886	A
3 - Coursers Road	287	72	312	828	0.346	286	312	0.4	0.5	6.637	A
4 - High Street	289	72	127	1224	0.236	289	472	0.2	0.3	3.848	A

08:30 - 08:45

Arm	Total Demand (Veh/hr)	Junction Arrivals (Veh)	Circulating flow (Veh/hr)	Capacity (Veh/hr)	RFC	Throughput (Veh/hr)	Throughput (exit side) (Veh/hr)	Start queue (Veh)	End queue (Veh)	Delay (s)	Unsignalised level of service
1 - Roestock Lane	122	31	453	720	0.170	122	56	0.2	0.2	6.015	A
2 - Tollgate Road	510	127	256	847	0.602	507	319	0.9	1.5	10.544	B
3 - Coursers Road	351	88	382	794	0.442	350	382	0.5	0.8	8.089	A
4 - High Street	355	89	155	1208	0.294	354	577	0.3	0.4	4.216	A

08:45 - 09:00

Arm	Total Demand (Veh/hr)	Junction Arrivals (Veh)	Circulating flow (Veh/hr)	Capacity (Veh/hr)	RFC	Throughput (Veh/hr)	Throughput (exit side) (Veh/hr)	Start queue (Veh)	End queue (Veh)	Delay (s)	Unsignalised level of service
1 - Roestock Lane	122	31	454	720	0.170	122	56	0.2	0.2	6.021	A
2 - Tollgate Road	510	127	257	846	0.602	510	319	1.5	1.5	10.686	B
3 - Coursers Road	351	88	383	793	0.443	351	383	0.8	0.8	8.144	A
4 - High Street	355	89	155	1207	0.294	355	579	0.4	0.4	4.220	A

09:00 - 09:15

Arm	Total Demand (Veh/hr)	Junction Arrivals (Veh)	Circulating flow (Veh/hr)	Capacity (Veh/hr)	RFC	Throughput (Veh/hr)	Throughput (exit side) (Veh/hr)	Start queue (Veh)	End queue (Veh)	Delay (s)	Unsignalised level of service
1 - Roestock Lane	100	25	371	759	0.132	100	46	0.2	0.2	5.468	A
2 - Tollgate Road	416	104	210	870	0.478	418	261	1.5	0.9	8.006	A
3 - Coursers Road	287	72	314	827	0.347	288	314	0.8	0.5	6.688	A
4 - High Street	289	72	127	1224	0.237	290	475	0.4	0.3	3.855	A

09:15 - 09:30

Arm	Total Demand (Veh/hr)	Junction Arrivals (Veh)	Circulating flow (Veh/hr)	Capacity (Veh/hr)	RFC	Throughput (Veh/hr)	Throughput (exit side) (Veh/hr)	Start queue (Veh)	End queue (Veh)	Delay (s)	Unsignalised level of service
1 - Roestock Lane	84	21	311	787	0.106	84	38	0.2	0.1	5.120	A
2 - Tollgate Road	349	87	176	888	0.393	350	219	0.9	0.7	6.703	A
3 - Coursers Road	240	60	263	852	0.282	241	263	0.5	0.4	5.890	A
4 - High Street	242	61	106	1236	0.196	243	397	0.3	0.2	3.623	A

2022, PM

Data Errors and Warnings

No errors or warnings

Junction Network

Junctions

Junction	Name	Junction type	Use circulating lanes	Arm order	Junction Delay (s)	Junction LOS
1	untitled	Standard Roundabout		1, 2, 3, 4	6.85	A

Junction Network

Driving side	Lighting	Network delay (s)	Network LOS
Left	Normal/unknown	6.85	A

Traffic Demand

Demand Set Details

ID	Scenario name	Time Period name	Traffic profile type	Start time (HH:mm)	Finish time (HH:mm)	Time segment length (min)	Run automatically
D2	2022	PM	ONE HOUR	17:00	18:30	15	✓

Vehicle mix varies over turn	Vehicle mix varies over entry	Vehicle mix source	PCU Factor for a HV (PCU)
✓	✓	HV Percentages	2.00

Demand overview (Traffic)

Arm	Linked arm	Profile type	Use O-D data	Average Demand (Veh/hr)	Scaling Factor (%)
1 - Roestock Lane		ONE HOUR	✓	65	100.000
2 - Tollgate Road		ONE HOUR	✓	306	100.000
3 - Coursers Road		ONE HOUR	✓	449	100.000
4 - High Street		ONE HOUR	✓	370	100.000

Origin-Destination Data

Demand (Veh/hr)

		To			
		1 - Roestock Lane	2 - Tollgate Road	3 - Coursers Road	4 - High Street
From	1 - Roestock Lane	0	7	18	40
	2 - Tollgate Road	6	1	154	145
	3 - Coursers Road	20	182	0	247
	4 - High Street	50	166	153	1

Vehicle Mix

Heavy Vehicle Percentages

		To			
		1 - Roestock Lane	2 - Tollgate Road	3 - Coursers Road	4 - High Street
From	1 - Roestock Lane	0	0	0	0
	2 - Tollgate Road	0	0	0	2
	3 - Coursers Road	0	1	0	1
	4 - High Street	2	1	0	0

Results

Results Summary for whole modelled period

Arm	Max RFC	Max Delay (s)	Max Queue (Veh)	Max LOS	Average Demand (Veh/hr)	Total Junction Arrivals (Veh)
1 - Roestock Lane	0.10	5.76	0.1	A	60	89
2 - Tollgate Road	0.39	6.79	0.6	A	281	421
3 - Coursers Road	0.55	8.98	1.2	A	412	618
4 - High Street	0.34	4.48	0.5	A	340	509

Main Results for each time segment

17:00 - 17:15

Arm	Total Demand (Veh/hr)	Junction Arrivals (Veh)	Circulating flow (Veh/hr)	Capacity (Veh/hr)	RFC	Throughput (Veh/hr)	Throughput (exit side) (Veh/hr)	Start queue (Veh)	End queue (Veh)	Delay (s)	Unsignalised level of service
1 - Roestock Lane	49	12	377	779	0.063	49	57	0.0	0.1	4.925	A
2 - Tollgate Road	230	58	159	904	0.255	229	267	0.0	0.3	5.322	A
3 - Coursers Road	338	85	144	929	0.364	336	243	0.0	0.6	6.046	A
4 - High Street	279	70	156	1255	0.222	277	324	0.0	0.3	3.679	A

17:15 - 17:30

Arm	Total Demand (Veh/hr)	Junction Arrivals (Veh)	Circulating flow (Veh/hr)	Capacity (Veh/hr)	RFC	Throughput (Veh/hr)	Throughput (exit side) (Veh/hr)	Start queue (Veh)	End queue (Veh)	Delay (s)	Unsignalised level of service
1 - Roestock Lane	58	15	452	744	0.078	58	68	0.1	0.1	5.247	A
2 - Tollgate Road	275	69	190	888	0.310	275	320	0.3	0.4	5.862	A
3 - Coursers Road	404	101	173	915	0.441	403	292	0.6	0.8	7.022	A
4 - High Street	333	83	187	1236	0.269	332	389	0.3	0.4	3.982	A

17:30 - 17:45

Arm	Total Demand (Veh/hr)	Junction Arrivals (Veh)	Circulating flow (Veh/hr)	Capacity (Veh/hr)	RFC	Throughput (Veh/hr)	Throughput (exit side) (Veh/hr)	Start queue (Veh)	End queue (Veh)	Delay (s)	Unsignalised level of service
1 - Roestock Lane	72	18	553	697	0.103	71	84	0.1	0.1	5.754	A
2 - Tollgate Road	337	84	233	867	0.389	336	391	0.4	0.6	6.772	A
3 - Coursers Road	494	124	212	895	0.552	493	357	0.8	1.2	8.900	A
4 - High Street	407	102	229	1210	0.337	407	475	0.4	0.5	4.477	A

17:45 - 18:00

Arm	Total Demand (Veh/hr)	Junction Arrivals (Veh)	Circulating flow (Veh/hr)	Capacity (Veh/hr)	RFC	Throughput (Veh/hr)	Throughput (exit side) (Veh/hr)	Start queue (Veh)	End queue (Veh)	Delay (s)	Unsignalised level of service
1 - Roestock Lane	72	18	554	697	0.103	72	84	0.1	0.1	5.759	A
2 - Tollgate Road	337	84	233	867	0.389	337	392	0.6	0.6	6.793	A
3 - Coursers Road	494	124	212	895	0.552	494	358	1.2	1.2	8.981	A
4 - High Street	407	102	230	1210	0.337	407	477	0.5	0.5	4.484	A

18:00 - 18:15

Arm	Total Demand (Veh/hr)	Junction Arrivals (Veh)	Circulating flow (Veh/hr)	Capacity (Veh/hr)	RFC	Throughput (Veh/hr)	Throughput (exit side) (Veh/hr)	Start queue (Veh)	End queue (Veh)	Delay (s)	Unsignalised level of service
1 - Roestock Lane	58	15	453	744	0.079	59	68	0.1	0.1	5.257	A
2 - Tollgate Road	275	69	191	888	0.310	276	321	0.6	0.5	5.888	A
3 - Coursers Road	404	101	174	914	0.442	405	293	1.2	0.8	7.098	A
4 - High Street	333	83	189	1235	0.269	333	391	0.5	0.4	3.994	A

18:15 - 18:30

Arm	Total Demand (Veh/hr)	Junction Arrivals (Veh)	Circulating flow (Veh/hr)	Capacity (Veh/hr)	RFC	Throughput (Veh/hr)	Throughput (exit side) (Veh/hr)	Start queue (Veh)	End queue (Veh)	Delay (s)	Unsignalised level of service
1 - Roestock Lane	49	12	379	778	0.063	49	57	0.1	0.1	4.938	A
2 - Tollgate Road	230	58	160	904	0.255	231	269	0.5	0.3	5.353	A
3 - Coursers Road	338	85	146	928	0.364	339	245	0.8	0.6	6.115	A
4 - High Street	279	70	158	1254	0.222	279	327	0.4	0.3	3.694	A

2027, AM

Data Errors and Warnings

No errors or warnings

Junction Network

Junctions

Junction	Name	Junction type	Use circulating lanes	Arm order	Junction Delay (s)	Junction LOS
1	untitled	Standard Roundabout		1, 2, 3, 4	8.09	A

Junction Network

Driving side	Lighting	Network delay (s)	Network LOS
Left	Normal/unknown	8.09	A

Traffic Demand

Demand Set Details

ID	Scenario name	Time Period name	Traffic profile type	Start time (HH:mm)	Finish time (HH:mm)	Time segment length (min)	Run automatically
D3	2027	AM	ONE HOUR	08:00	09:30	15	✓

Vehicle mix varies over turn	Vehicle mix varies over entry	Vehicle mix source	PCU Factor for a HV (PCU)
✓	✓	HV Percentages	2.00

Demand overview (Traffic)

Arm	Linked arm	Profile type	Use O-D data	Average Demand (Veh/hr)	Scaling Factor (%)
1 - Roestock Lane		ONE HOUR	✓	112	100.000
2 - Tollgate Road		ONE HOUR	✓	470	100.000
3 - Coursers Road		ONE HOUR	✓	324	100.000
4 - High Street		ONE HOUR	✓	327	100.000

Origin-Destination Data

Demand (Veh/hr)

		To			
		1 - Roestock Lane	2 - Tollgate Road	3 - Coursers Road	4 - High Street
From	1 - Roestock Lane	0	7	17	88
	2 - Tollgate Road	1	0	206	263
	3 - Coursers Road	15	126	1	182
	4 - High Street	36	161	129	1

Vehicle Mix

Heavy Vehicle Percentages

		To			
		1 - Roestock Lane	2 - Tollgate Road	3 - Coursers Road	4 - High Street
From	1 - Roestock Lane	0	15	0	2
	2 - Tollgate Road	0	0	2	2
	3 - Coursers Road	7	1	0	5
	4 - High Street	6	5	4	0

Results

Results Summary for whole modelled period

Arm	Max RFC	Max Delay (s)	Max Queue (Veh)	Max LOS	Average Demand (Veh/hr)	Total Junction Arrivals (Veh)
1 - Roestock Lane	0.17	6.07	0.2	A	103	154
2 - Tollgate Road	0.62	11.11	1.6	B	431	647
3 - Coursers Road	0.45	8.38	0.8	A	297	446
4 - High Street	0.30	4.25	0.4	A	300	450

Main Results for each time segment

08:00 - 08:15

Arm	Total Demand (Veh/hr)	Junction Arrivals (Veh)	Circulating flow (Veh/hr)	Capacity (Veh/hr)	RFC	Throughput (Veh/hr)	Throughput (exit side) (Veh/hr)	Start queue (Veh)	End queue (Veh)	Delay (s)	Unsignalised level of service
1 - Roestock Lane	84	21	313	785	0.107	84	39	0.0	0.1	5.128	A
2 - Tollgate Road	354	88	177	883	0.401	351	220	0.0	0.7	6.734	A
3 - Coursers Road	244	61	264	847	0.288	242	264	0.0	0.4	5.936	A
4 - High Street	246	62	107	1236	0.199	245	399	0.0	0.2	3.630	A

08:15 - 08:30

Arm	Total Demand (Veh/hr)	Junction Arrivals (Veh)	Circulating flow (Veh/hr)	Capacity (Veh/hr)	RFC	Throughput (Veh/hr)	Throughput (exit side) (Veh/hr)	Start queue (Veh)	End queue (Veh)	Delay (s)	Unsignalised level of service
1 - Roestock Lane	101	25	375	756	0.133	101	47	0.1	0.2	5.488	A
2 - Tollgate Road	423	106	212	865	0.488	421	264	0.7	0.9	8.086	A
3 - Coursers Road	291	73	317	821	0.355	291	317	0.4	0.5	6.776	A
4 - High Street	294	73	128	1223	0.240	294	479	0.2	0.3	3.871	A

08:30 - 08:45

Arm	Total Demand (Veh/hr)	Junction Arrivals (Veh)	Circulating flow (Veh/hr)	Capacity (Veh/hr)	RFC	Throughput (Veh/hr)	Throughput (exit side) (Veh/hr)	Start queue (Veh)	End queue (Veh)	Delay (s)	Unsignalised level of service
1 - Roestock Lane	123	31	459	717	0.172	123	57	0.2	0.2	6.062	A
2 - Tollgate Road	517	129	259	841	0.615	515	323	0.9	1.6	10.951	B
3 - Coursers Road	357	89	387	787	0.453	356	387	0.5	0.8	8.326	A
4 - High Street	360	90	157	1206	0.298	360	586	0.3	0.4	4.250	A

08:45 - 09:00

Arm	Total Demand (Veh/hr)	Junction Arrivals (Veh)	Circulating flow (Veh/hr)	Capacity (Veh/hr)	RFC	Throughput (Veh/hr)	Throughput (exit side) (Veh/hr)	Start queue (Veh)	End queue (Veh)	Delay (s)	Unsignalised level of service
1 - Roestock Lane	123	31	460	716	0.172	123	57	0.2	0.2	6.068	A
2 - Tollgate Road	517	129	260	841	0.615	517	324	1.6	1.6	11.114	B
3 - Coursers Road	357	89	389	786	0.454	357	389	0.8	0.8	8.381	A
4 - High Street	360	90	157	1206	0.299	360	588	0.4	0.4	4.254	A

09:00 - 09:15

Arm	Total Demand (Veh/hr)	Junction Arrivals (Veh)	Circulating flow (Veh/hr)	Capacity (Veh/hr)	RFC	Throughput (Veh/hr)	Throughput (exit side) (Veh/hr)	Start queue (Veh)	End queue (Veh)	Delay (s)	Unsignalised level of service
1 - Roestock Lane	101	25	377	756	0.133	101	47	0.2	0.2	5.498	A
2 - Tollgate Road	423	106	213	865	0.488	425	265	1.6	1.0	8.221	A
3 - Coursers Road	291	73	319	820	0.355	292	319	0.8	0.6	6.831	A
4 - High Street	294	73	129	1223	0.240	294	482	0.4	0.3	3.878	A

09:15 - 09:30

Arm	Total Demand (Veh/hr)	Junction Arrivals (Veh)	Circulating flow (Veh/hr)	Capacity (Veh/hr)	RFC	Throughput (Veh/hr)	Throughput (exit side) (Veh/hr)	Start queue (Veh)	End queue (Veh)	Delay (s)	Unsignalised level of service
1 - Roestock Lane	84	21	315	785	0.107	84	39	0.2	0.1	5.142	A
2 - Tollgate Road	354	88	178	883	0.401	355	222	1.0	0.7	6.838	A
3 - Coursers Road	244	61	267	846	0.288	245	266	0.6	0.4	5.991	A
4 - High Street	246	62	108	1235	0.199	246	403	0.3	0.3	3.643	A

2027, PM

Data Errors and Warnings

No errors or warnings

Junction Network

Junctions

Junction	Name	Junction type	Use circulating lanes	Arm order	Junction Delay (s)	Junction LOS
1	untitled	Standard Roundabout		1, 2, 3, 4	6.97	A

Junction Network

Driving side	Lighting	Network delay (s)	Network LOS
Left	Normal/unknown	6.97	A

Traffic Demand

Demand Set Details

ID	Scenario name	Time Period name	Traffic profile type	Start time (HH:mm)	Finish time (HH:mm)	Time segment length (min)	Run automatically
D4	2027	PM	ONE HOUR	17:00	18:30	15	✓

Vehicle mix varies over turn	Vehicle mix varies over entry	Vehicle mix source	PCU Factor for a HV (PCU)
✓	✓	HV Percentages	2.00

Demand overview (Traffic)

Arm	Linked arm	Profile type	Use O-D data	Average Demand (Veh/hr)	Scaling Factor (%)
1 - Roestock Lane		ONE HOUR	✓	66	100.000
2 - Tollgate Road		ONE HOUR	✓	310	100.000
3 - Coursers Road		ONE HOUR	✓	456	100.000
4 - High Street		ONE HOUR	✓	376	100.000

Origin-Destination Data

Demand (Veh/hr)

		To			
		1 - Roestock Lane	2 - Tollgate Road	3 - Coursers Road	4 - High Street
From	1 - Roestock Lane	0	7	18	41
	2 - Tollgate Road	6	1	156	147
	3 - Coursers Road	20	185	0	251
	4 - High Street	51	169	155	1

Vehicle Mix

Heavy Vehicle Percentages

		To			
		1 - Roestock Lane	2 - Tollgate Road	3 - Coursers Road	4 - High Street
From	1 - Roestock Lane	0	0	0	0
	2 - Tollgate Road	0	0	0	2
	3 - Coursers Road	0	1	0	1
	4 - High Street	2	1	0	0

Results

Results Summary for whole modelled period

Arm	Max RFC	Max Delay (s)	Max Queue (Veh)	Max LOS	Average Demand (Veh/hr)	Total Junction Arrivals (Veh)
1 - Roestock Lane	0.10	5.81	0.1	A	61	91
2 - Tollgate Road	0.39	6.87	0.6	A	284	427
3 - Coursers Road	0.56	9.20	1.3	A	418	628
4 - High Street	0.34	4.53	0.5	A	345	518

Main Results for each time segment

17:00 - 17:15

Arm	Total Demand (Veh/hr)	Junction Arrivals (Veh)	Circulating flow (Veh/hr)	Capacity (Veh/hr)	RFC	Throughput (Veh/hr)	Throughput (exit side) (Veh/hr)	Start queue (Veh)	End queue (Veh)	Delay (s)	Unsignalised level of service
1 - Roestock Lane	50	12	383	777	0.064	49	58	0.0	0.1	4.949	A
2 - Tollgate Road	233	58	161	903	0.258	232	271	0.0	0.3	5.355	A
3 - Coursers Road	343	86	147	928	0.370	341	246	0.0	0.6	6.116	A
4 - High Street	283	71	159	1254	0.226	282	329	0.0	0.3	3.699	A

17:15 - 17:30

Arm	Total Demand (Veh/hr)	Junction Arrivals (Veh)	Circulating flow (Veh/hr)	Capacity (Veh/hr)	RFC	Throughput (Veh/hr)	Throughput (exit side) (Veh/hr)	Start queue (Veh)	End queue (Veh)	Delay (s)	Unsignalised level of service
1 - Roestock Lane	59	15	459	741	0.080	59	69	0.1	0.1	5.280	A
2 - Tollgate Road	279	70	193	887	0.314	278	325	0.3	0.5	5.910	A
3 - Coursers Road	410	102	176	913	0.449	409	295	0.6	0.8	7.126	A
4 - High Street	338	85	190	1234	0.274	338	395	0.3	0.4	4.015	A

17:30 - 17:45

Arm	Total Demand (Veh/hr)	Junction Arrivals (Veh)	Circulating flow (Veh/hr)	Capacity (Veh/hr)	RFC	Throughput (Veh/hr)	Throughput (exit side) (Veh/hr)	Start queue (Veh)	End queue (Veh)	Delay (s)	Unsignalised level of service
1 - Roestock Lane	73	18	561	693	0.105	73	85	0.1	0.1	5.802	A
2 - Tollgate Road	341	85	236	865	0.394	341	398	0.5	0.6	6.850	A
3 - Coursers Road	502	126	215	894	0.562	500	362	0.8	1.3	9.110	A
4 - High Street	414	103	233	1208	0.343	413	483	0.4	0.5	4.525	A

17:45 - 18:00

Arm	Total Demand (Veh/hr)	Junction Arrivals (Veh)	Circulating flow (Veh/hr)	Capacity (Veh/hr)	RFC	Throughput (Veh/hr)	Throughput (exit side) (Veh/hr)	Start queue (Veh)	End queue (Veh)	Delay (s)	Unsignalised level of service
1 - Roestock Lane	73	18	563	692	0.105	73	85	0.1	0.1	5.807	A
2 - Tollgate Road	341	85	237	865	0.395	341	399	0.6	0.6	6.871	A
3 - Coursers Road	502	126	216	893	0.562	502	362	1.3	1.3	9.196	A
4 - High Street	414	103	233	1208	0.343	414	484	0.5	0.5	4.533	A

18:00 - 18:15

Arm	Total Demand (Veh/hr)	Junction Arrivals (Veh)	Circulating flow (Veh/hr)	Capacity (Veh/hr)	RFC	Throughput (Veh/hr)	Throughput (exit side) (Veh/hr)	Start queue (Veh)	End queue (Veh)	Delay (s)	Unsignalised level of service
1 - Roestock Lane	59	15	461	740	0.080	59	69	0.1	0.1	5.290	A
2 - Tollgate Road	279	70	194	887	0.314	279	326	0.6	0.5	5.934	A
3 - Coursers Road	410	102	177	913	0.449	412	296	1.3	0.8	7.207	A
4 - High Street	338	85	191	1234	0.274	339	397	0.5	0.4	4.025	A

18:15 - 18:30

Arm	Total Demand (Veh/hr)	Junction Arrivals (Veh)	Circulating flow (Veh/hr)	Capacity (Veh/hr)	RFC	Throughput (Veh/hr)	Throughput (exit side) (Veh/hr)	Start queue (Veh)	End queue (Veh)	Delay (s)	Unsignalised level of service
1 - Roestock Lane	50	12	385	775	0.064	50	58	0.1	0.1	4.961	A
2 - Tollgate Road	233	58	162	902	0.259	234	273	0.5	0.4	5.387	A
3 - Coursers Road	343	86	148	927	0.370	344	248	0.8	0.6	6.183	A
4 - High Street	283	71	160	1253	0.226	283	332	0.4	0.3	3.713	A

2027 + Dev, AM

Data Errors and Warnings

No errors or warnings

Junction Network

Junctions

Junction	Name	Junction type	Use circulating lanes	Arm order	Junction Delay (s)	Junction LOS
1	untitled	Standard Roundabout		1, 2, 3, 4	8.77	A

Junction Network

Driving side	Lighting	Network delay (s)	Network LOS
Left	Normal/unknown	8.77	A

Traffic Demand

Demand Set Details

ID	Scenario name	Time Period name	Traffic profile type	Start time (HH:mm)	Finish time (HH:mm)	Time segment length (min)	Run automatically
D5	2027 + Dev	AM	ONE HOUR	08:00	09:30	15	✓

Vehicle mix varies over turn	Vehicle mix varies over entry	Vehicle mix source	PCU Factor for a HV (PCU)
✓	✓	HV Percentages	2.00

Demand overview (Traffic)

Arm	Linked arm	Profile type	Use O-D data	Average Demand (Veh/hr)	Scaling Factor (%)
1 - Roestock Lane		ONE HOUR	✓	112	100.000
2 - Tollgate Road		ONE HOUR	✓	502	100.000
3 - Coursers Road		ONE HOUR	✓	330	100.000
4 - High Street		ONE HOUR	✓	335	100.000

Origin-Destination Data

Demand (Veh/hr)

		To			
		1 - Roestock Lane	2 - Tollgate Road	3 - Coursers Road	4 - High Street
From	1 - Roestock Lane	0	7	17	88
	2 - Tollgate Road	1	0	220	281
	3 - Coursers Road	15	132	1	182
	4 - High Street	36	169	129	1

Vehicle Mix

Heavy Vehicle Percentages

		To			
		1 - Roestock Lane	2 - Tollgate Road	3 - Coursers Road	4 - High Street
From	1 - Roestock Lane	0	15	0	2
	2 - Tollgate Road	0	0	2	2
	3 - Coursers Road	7	1	0	5
	4 - High Street	6	5	4	0

Results

Results Summary for whole modelled period

Arm	Max RFC	Max Delay (s)	Max Queue (Veh)	Max LOS	Average Demand (Veh/hr)	Total Junction Arrivals (Veh)
1 - Roestock Lane	0.17	6.14	0.2	A	103	154
2 - Tollgate Road	0.66	12.46	1.9	B	461	691
3 - Coursers Road	0.47	8.70	0.9	A	303	454
4 - High Street	0.31	4.32	0.4	A	307	461

Main Results for each time segment

08:00 - 08:15

Arm	Total Demand (Veh/hr)	Junction Arrivals (Veh)	Circulating flow (Veh/hr)	Capacity (Veh/hr)	RFC	Throughput (Veh/hr)	Throughput (exit side) (Veh/hr)	Start queue (Veh)	End queue (Veh)	Delay (s)	Unsignalised level of service
1 - Roestock Lane	84	21	324	781	0.108	84	39	0.0	0.1	5.164	A
2 - Tollgate Road	378	94	177	883	0.428	375	231	0.0	0.7	7.041	A
3 - Coursers Road	248	62	277	841	0.295	247	275	0.0	0.4	6.041	A
4 - High Street	252	63	111	1233	0.205	251	413	0.0	0.3	3.662	A

08:15 - 08:30

Arm	Total Demand (Veh/hr)	Junction Arrivals (Veh)	Circulating flow (Veh/hr)	Capacity (Veh/hr)	RFC	Throughput (Veh/hr)	Throughput (exit side) (Veh/hr)	Start queue (Veh)	End queue (Veh)	Delay (s)	Unsignalised level of service
1 - Roestock Lane	101	25	388	750	0.134	101	47	0.1	0.2	5.538	A
2 - Tollgate Road	451	113	212	865	0.521	450	276	0.7	1.1	8.635	A
3 - Coursers Road	297	74	333	814	0.365	296	329	0.4	0.6	6.943	A
4 - High Street	301	75	134	1220	0.247	301	495	0.3	0.3	3.915	A

08:30 - 08:45

Arm	Total Demand (Veh/hr)	Junction Arrivals (Veh)	Circulating flow (Veh/hr)	Capacity (Veh/hr)	RFC	Throughput (Veh/hr)	Throughput (exit side) (Veh/hr)	Start queue (Veh)	End queue (Veh)	Delay (s)	Unsignalised level of service
1 - Roestock Lane	123	31	475	710	0.174	123	57	0.2	0.2	6.136	A
2 - Tollgate Road	553	138	259	841	0.657	550	338	1.1	1.8	12.210	B
3 - Coursers Road	363	91	407	778	0.467	362	403	0.6	0.9	8.637	A
4 - High Street	369	92	164	1202	0.307	368	605	0.3	0.4	4.315	A

08:45 - 09:00

Arm	Total Demand (Veh/hr)	Junction Arrivals (Veh)	Circulating flow (Veh/hr)	Capacity (Veh/hr)	RFC	Throughput (Veh/hr)	Throughput (exit side) (Veh/hr)	Start queue (Veh)	End queue (Veh)	Delay (s)	Unsignalised level of service
1 - Roestock Lane	123	31	476	709	0.174	123	57	0.2	0.2	6.143	A
2 - Tollgate Road	553	138	260	841	0.657	553	339	1.8	1.9	12.463	B
3 - Coursers Road	363	91	408	777	0.468	363	404	0.9	0.9	8.704	A
4 - High Street	369	92	164	1202	0.307	369	608	0.4	0.4	4.320	A

09:00 - 09:15

Arm	Total Demand (Veh/hr)	Junction Arrivals (Veh)	Circulating flow (Veh/hr)	Capacity (Veh/hr)	RFC	Throughput (Veh/hr)	Throughput (exit side) (Veh/hr)	Start queue (Veh)	End queue (Veh)	Delay (s)	Unsignalised level of service
1 - Roestock Lane	101	25	389	750	0.134	101	47	0.2	0.2	5.549	A
2 - Tollgate Road	451	113	213	865	0.522	454	278	1.9	1.1	8.827	A
3 - Coursers Road	297	74	335	813	0.365	298	331	0.9	0.6	7.008	A
4 - High Street	301	75	134	1220	0.247	302	499	0.4	0.3	3.924	A

09:15 - 09:30

Arm	Total Demand (Veh/hr)	Junction Arrivals (Veh)	Circulating flow (Veh/hr)	Capacity (Veh/hr)	RFC	Throughput (Veh/hr)	Throughput (exit side) (Veh/hr)	Start queue (Veh)	End queue (Veh)	Delay (s)	Unsignalised level of service
1 - Roestock Lane	84	21	326	780	0.108	84	39	0.2	0.1	5.179	A
2 - Tollgate Road	378	94	178	883	0.428	379	232	1.1	0.8	7.170	A
3 - Coursers Road	248	62	280	840	0.296	249	277	0.6	0.4	6.102	A
4 - High Street	252	63	112	1233	0.205	252	417	0.3	0.3	3.675	A

2027 + Dev, PM

Data Errors and Warnings

No errors or warnings

Junction Network

Junctions

Junction	Name	Junction type	Use circulating lanes	Arm order	Junction Delay (s)	Junction LOS
1	untitled	Standard Roundabout		1, 2, 3, 4	7.27	A

Junction Network

Driving side	Lighting	Network delay (s)	Network LOS
Left	Normal/unknown	7.27	A

Traffic Demand

Demand Set Details

ID	Scenario name	Time Period name	Traffic profile type	Start time (HH:mm)	Finish time (HH:mm)	Time segment length (min)	Run automatically
D6	2027 + Dev	PM	ONE HOUR	17:00	18:30	15	✓

Vehicle mix varies over turn	Vehicle mix varies over entry	Vehicle mix source	PCU Factor for a HV (PCU)
✓	✓	HV Percentages	2.00

Demand overview (Traffic)

Arm	Linked arm	Profile type	Use O-D data	Average Demand (Veh/hr)	Scaling Factor (%)
1 - Roestock Lane		ONE HOUR	✓	66	100.000
2 - Tollgate Road		ONE HOUR	✓	328	100.000
3 - Coursers Road		ONE HOUR	✓	469	100.000
4 - High Street		ONE HOUR	✓	393	100.000

Origin-Destination Data

Demand (Veh/hr)

		To			
		1 - Roestock Lane	2 - Tollgate Road	3 - Coursers Road	4 - High Street
From	1 - Roestock Lane	0	7	18	41
	2 - Tollgate Road	6	1	164	157
	3 - Coursers Road	20	198	0	251
	4 - High Street	51	186	155	1

Vehicle Mix

Heavy Vehicle Percentages

		To			
		1 - Roestock Lane	2 - Tollgate Road	3 - Coursers Road	4 - High Street
From	1 - Roestock Lane	0	0	0	0
	2 - Tollgate Road	0	0	0	2
	3 - Coursers Road	0	1	0	1
	4 - High Street	2	1	0	0

Results

Results Summary for whole modelled period

Arm	Max RFC	Max Delay (s)	Max Queue (Veh)	Max LOS	Average Demand (Veh/hr)	Total Junction Arrivals (Veh)
1 - Roestock Lane	0.11	5.96	0.1	A	61	91
2 - Tollgate Road	0.42	7.14	0.7	A	301	451
3 - Coursers Road	0.58	9.69	1.4	A	430	646
4 - High Street	0.36	4.70	0.6	A	361	541

Main Results for each time segment

17:00 - 17:15

Arm	Total Demand (Veh/hr)	Junction Arrivals (Veh)	Circulating flow (Veh/hr)	Capacity (Veh/hr)	RFC	Throughput (Veh/hr)	Throughput (exit side) (Veh/hr)	Start queue (Veh)	End queue (Veh)	Delay (s)	Unsignalised level of service
1 - Roestock Lane	50	12	405	766	0.065	49	58	0.0	0.1	5.023	A
2 - Tollgate Road	247	62	161	903	0.274	245	293	0.0	0.4	5.464	A
3 - Coursers Road	353	88	154	924	0.382	351	252	0.0	0.6	6.252	A
4 - High Street	296	74	168	1248	0.237	295	337	0.0	0.3	3.772	A

17:15 - 17:30

Arm	Total Demand (Veh/hr)	Junction Arrivals (Veh)	Circulating flow (Veh/hr)	Capacity (Veh/hr)	RFC	Throughput (Veh/hr)	Throughput (exit side) (Veh/hr)	Start queue (Veh)	End queue (Veh)	Delay (s)	Unsignalised level of service
1 - Roestock Lane	59	15	486	728	0.081	59	69	0.1	0.1	5.379	A
2 - Tollgate Road	295	74	193	887	0.332	294	352	0.4	0.5	6.070	A
3 - Coursers Road	422	105	185	909	0.464	421	303	0.6	0.9	7.360	A
4 - High Street	353	88	202	1227	0.288	353	404	0.3	0.4	4.116	A

17:30 - 17:45

Arm	Total Demand (Veh/hr)	Junction Arrivals (Veh)	Circulating flow (Veh/hr)	Capacity (Veh/hr)	RFC	Throughput (Veh/hr)	Throughput (exit side) (Veh/hr)	Start queue (Veh)	End queue (Veh)	Delay (s)	Unsignalised level of service
1 - Roestock Lane	73	18	594	678	0.107	73	85	0.1	0.1	5.948	A
2 - Tollgate Road	361	90	236	865	0.417	360	430	0.5	0.7	7.118	A
3 - Coursers Road	516	129	226	888	0.581	514	370	0.9	1.4	9.581	A
4 - High Street	433	108	247	1200	0.361	432	494	0.4	0.6	4.686	A

17:45 - 18:00

Arm	Total Demand (Veh/hr)	Junction Arrivals (Veh)	Circulating flow (Veh/hr)	Capacity (Veh/hr)	RFC	Throughput (Veh/hr)	Throughput (exit side) (Veh/hr)	Start queue (Veh)	End queue (Veh)	Delay (s)	Unsignalised level of service
1 - Roestock Lane	73	18	596	677	0.107	73	85	0.1	0.1	5.956	A
2 - Tollgate Road	361	90	237	865	0.417	361	432	0.7	0.7	7.142	A
3 - Coursers Road	516	129	227	888	0.582	516	371	1.4	1.4	9.686	A
4 - High Street	433	108	248	1199	0.361	433	495	0.6	0.6	4.697	A

18:00 - 18:15

Arm	Total Demand (Veh/hr)	Junction Arrivals (Veh)	Circulating flow (Veh/hr)	Capacity (Veh/hr)	RFC	Throughput (Veh/hr)	Throughput (exit side) (Veh/hr)	Start queue (Veh)	End queue (Veh)	Delay (s)	Unsignalised level of service
1 - Roestock Lane	59	15	488	727	0.082	59	69	0.1	0.1	5.391	A
2 - Tollgate Road	295	74	194	887	0.333	296	354	0.7	0.5	6.100	A
3 - Coursers Road	422	105	186	908	0.464	424	304	1.4	0.9	7.458	A
4 - High Street	353	88	203	1226	0.288	354	406	0.6	0.4	4.131	A

18:15 - 18:30

Arm	Total Demand (Veh/hr)	Junction Arrivals (Veh)	Circulating flow (Veh/hr)	Capacity (Veh/hr)	RFC	Throughput (Veh/hr)	Throughput (exit side) (Veh/hr)	Start queue (Veh)	End queue (Veh)	Delay (s)	Unsignalised level of service
1 - Roestock Lane	50	12	408	765	0.065	50	58	0.1	0.1	5.035	A
2 - Tollgate Road	247	62	162	902	0.274	247	296	0.5	0.4	5.502	A
3 - Coursers Road	353	88	155	923	0.382	354	254	0.9	0.6	6.333	A
4 - High Street	296	74	170	1247	0.237	296	340	0.4	0.3	3.791	A

Junctions 10
ARCADY 10 - Roundabout Module
Version: 10.0.3.1598 © Copyright TRL Software Limited, 2021
For sales and distribution information, program advice and maintenance, contact TRL Software: +44 (0)1344 379777 software@trl.co.uk trlsoftware.com
The users of this computer program for the solution of an engineering problem are in no way relieved of their responsibility for the correctness of the solution

Filename: Tollgate Rd (Obstructions Model) - TRL.j10
 Path: P:\JNY11289 - Colney Heath\Transport\Picady
 Report generation date: 24/05/2022 10:22:17

- »2022 Base, AM
- »2022 Base, PM
- »2027 Base, AM
- »2027 Base, PM
- »2027 Base + Dev, AM
- »2027 Base + Dev, PM

Summary of junction performance

	AM					PM				
	Set ID	Queue (Veh)	Delay (s)	RFC	LOS	Set ID	Queue (Veh)	Delay (s)	RFC	LOS
[Lane Simulation] - 2022 Base										
1 - Tollgate Rd (S)	D1	0.4	3.66		A	D2	0.4	3.56		A
2 - Tollgate Rd (N)		0.3	3.22		A		0.0	0.19		A
[Lane Simulation] - 2027 Base										
1 - Tollgate Rd (S)	D3	0.5	3.65		A	D4	0.4	3.47		A
2 - Tollgate Rd (N)		0.6	5.02		A		0.0	0.45		A
[Lane Simulation] - 2027 Base + Dev										
1 - Tollgate Rd (S)	D5	0.5	3.69		A	D6	0.3	3.52		A
2 - Tollgate Rd (N)		1.0	8.22		A		0.0	0.41		A

Values shown are the highest values encountered over all time segments. Delay is the maximum value of average delay per arriving vehicle. Arm and junction delays are averages for all movements, including movements with zero delay.

File summary

File Description

Title	
Location	
Site number	
Date	17/05/2022
Version	
Status	(new file)
Identifier	
Client	
Jobnumber	
Enumerator	EUR\George.Magnisalis
Description	

Units

Distance units	Speed units	Traffic units input	Traffic units results	Flow units	Average delay units	Total delay units	Rate of delay units
m	kph	Veh	Veh	perHour	s	-Min	perMin

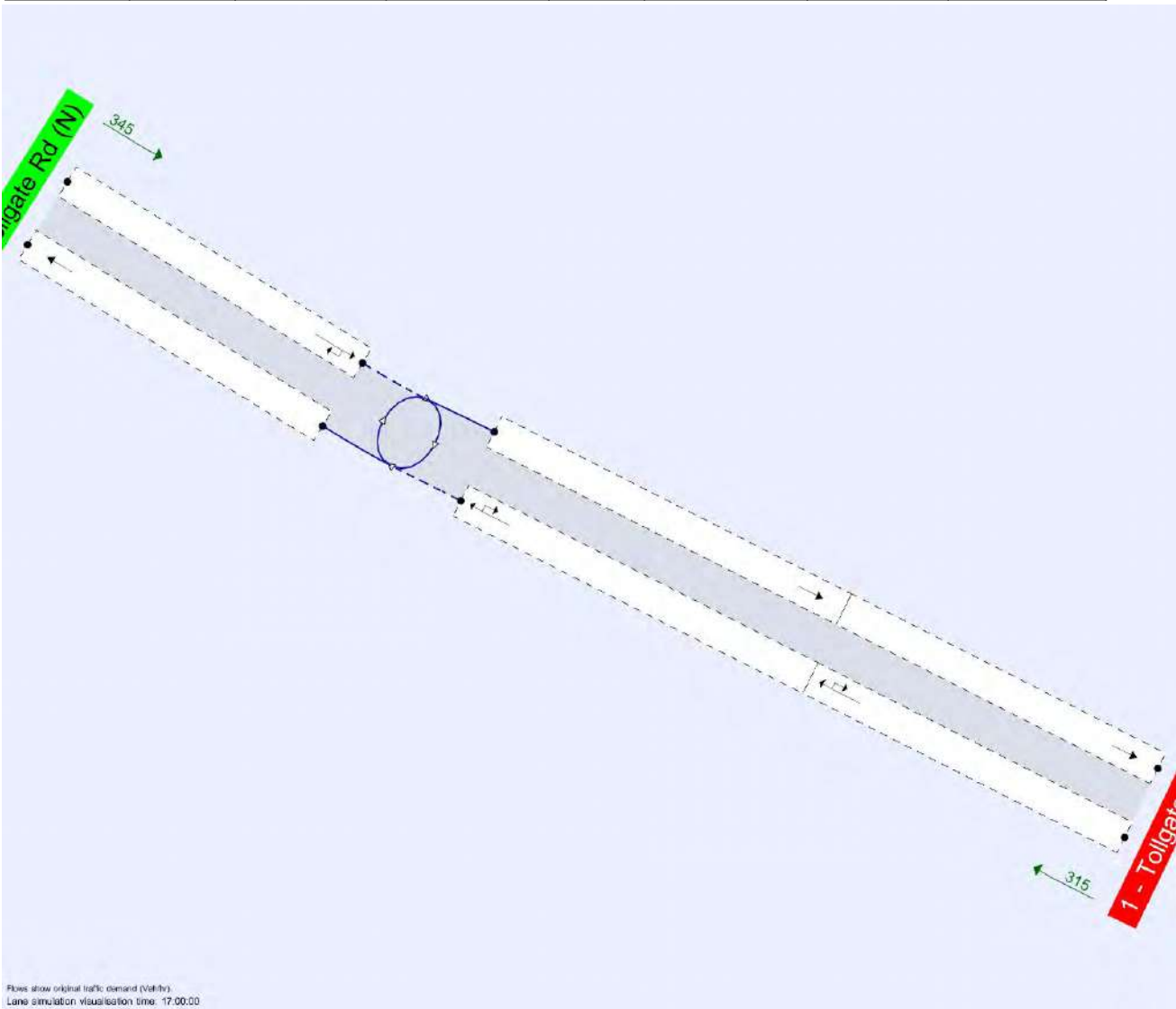

The junction diagram reflects the last run of Junctions.

Analysis Options

Vehicle length (m)	Calculate Queue Percentiles	Calculate detailed queueing delay	Show lane queues in feet / metres	Show all PICADY stream intercepts	Calculate residual capacity	RFC Threshold	Average Delay threshold (s)	Queue threshold (PCU)	Use iterations with HCM roundabouts	Max number of iterations for roundabouts
5.75						0.85	36.00	20.00		500

Lane Simulation options

Criteria type	Stop criteria (%)	Stop criteria time (s)	Stop criteria number of trials	Random seed	Results refresh speed (s)	Individual vehicle animation number of trials	Average animation capture interval (s)	Use quick response	Do flow sampling	Suppress automatic lane creation	Last run random seed	Last run number of trials	Last run time taken (s)
Delay	1.00	100000	100000	-1	3	1	60	✓		✓	175277788	101	2.17

Demand Set Summary

ID	Scenario name	Time Period name	Traffic profile type	Start time (HH:mm)	Finish time (HH:mm)	Time segment length (min)	Run automatically
D1	2022 Base	AM	ONE HOUR	08:00	09:30	15	✓
D2	2022 Base	PM	ONE HOUR	17:00	18:30	15	✓
D3	2027 Base	AM	ONE HOUR	08:00	09:30	15	✓
D4	2027 Base	PM	ONE HOUR	17:00	18:30	15	✓
D5	2027 Base + Dev	AM	ONE HOUR	08:00	09:30	15	✓
D6	2027 Base + Dev	PM	ONE HOUR	17:00	18:30	15	✓

Analysis Set Details

ID	Use Lane Simulation	Include in report	Network flow scaling factor (%)	Network capacity scaling factor (%)
A1	✓	✓	100.000	100.000

2022 Base, AM

Data Errors and Warnings

Severity	Area	Item	Description
Info	Lane Simulation	A1 - [Lane Simulation]	This analysis set uses Lane Simulation mode. For detailed information on this mode, please see the User Guide.

Junction Network

Junctions

Junction	Name	Junction type	Use circulating lanes	Arm order	Junction Delay (s)	Junction LOS
1	Tollgate Rd	Standard Roundabout		1, 2	3.49	A

Junction Network

Driving side	Lighting	Network delay (s)	Network LOS
Left	Normal/unknown	3.49	A

Arms

Arms

Arm	Name	Description	No give-way line
1	Tollgate Rd (S)		✓
2	Tollgate Rd (N)		✓

Roundabout Geometry

Arm	Entry only	Exit only
1 - Tollgate Rd (S)		
2 - Tollgate Rd (N)		

Slope / Intercept / Capacity

Roundabout Slope and Intercept used in model

Arm	Final intercept (PCU/hr)
1 - Tollgate Rd (S)	99999
2 - Tollgate Rd (N)	99999

The slope and intercept shown above include any corrections and adjustments.

Lane Simulation: Arm options

Arm	Lane capacity source	Traffic considering secondary lanes (%)
1 - Tollgate Rd (S)	Evenly split	10.00
2 - Tollgate Rd (N)	Evenly split	10.00

Lanes

Arm	Side	Lane level	Lane	Destination arms	Has limited storage	Storage (PCU)	Has bottleneck	Has obstruction	Obstruction traversal time (s)	Obstruction other lane	Obstruction has priority	Obstruction saturation flow (PCU/hr)	Minimum capacity (PCU/hr)
1 - Tollgate Rd (S)	Entry	1	1	1, 2	✓	10.00							0
		2	1	(1, 2)		Infinity		✓	5.00	1/Exit/1/1	✓	1800	0
	Exit	1	1		✓	10.00		✓	5.00	1/Entry/2/1		1800	0
		2	1			Infinity							0
2 - Tollgate Rd (N)	Entry	1	1	1, 2		Infinity							0
	Exit	1	1			Infinity							0

Entry Lane slope and intercept

Arm	Side	Lane level	Lane	Final slope	Final intercept (PCU/hr)
1 - Tollgate Rd (S)	Entry	1	1	0.000	99999
2 - Tollgate Rd (N)	Entry	1	1	0.000	99999

Summary of Entry Lane allowed movements

Arm	Lane Level	Lane	Destination arm	
			Tollgate Rd (S)	Tollgate Rd (N)
1 - Tollgate Rd (S)	1	1	✓	✓
	2	1	✓	✓
2 - Tollgate Rd (N)	1	1	✓	✓

Traffic Demand

Demand Set Details

ID	Scenario name	Time Period name	Traffic profile type	Start time (HH:mm)	Finish time (HH:mm)	Time segment length (min)	Run automatically
D1	2022 Base	AM	ONE HOUR	08:00	09:30	15	✓

Vehicle mix varies over turn	Vehicle mix varies over entry	Vehicle mix source	PCU Factor for a HV (PCU)
✓	✓	HV Percentages	2.00

Demand overview (Traffic)

Arm	Linked arm	Profile type	Use O-D data	Average Demand (Veh/hr)	Scaling Factor (%)
1 - Tollgate Rd (S)		ONE HOUR	✓	441	100.000
2 - Tollgate Rd (N)		ONE HOUR	✓	283	100.000

Origin-Destination Data

Demand (Veh/hr)

From	To	
	1 - Tollgate Rd (S)	2 - Tollgate Rd (N)
1 - Tollgate Rd (S)	0	441
2 - Tollgate Rd (N)	283	0

Vehicle Mix

Heavy Vehicle Percentages

From	To	
	1 - Tollgate Rd (S)	2 - Tollgate Rd (N)
1 - Tollgate Rd (S)	0	2
2 - Tollgate Rd (N)	3	0

Results

Results Summary for whole modelled period

Arm	Max Delay (s)	Max Queue (Veh)	Max LOS	Average Demand (Veh/hr)	Total Junction Arrivals (Veh)
1 - Tollgate Rd (S)	3.66	0.4	A	405	608
2 - Tollgate Rd (N)	3.22	0.3	A	262	392

Main Results for each time segment

08:00 - 08:15

Arm	Total Demand (Veh/hr)	Junction Arrivals (Veh)	Circulating flow (Veh/hr)	Throughput (Veh/hr)	Average throughput (PCU/hr)	Throughput (exit side) (Veh/hr)	Start queue (Veh)	End queue (Veh)	Delay (s)	Unsignalised level of service
1 - Tollgate Rd (S)	322	81	0	323	337	219	0.0	0.3	3.056	A
2 - Tollgate Rd (N)	218	55	0	218	222	323	0.0	0.0	0.036	A

08:15 - 08:30

Arm	Total Demand (Veh/hr)	Junction Arrivals (Veh)	Circulating flow (Veh/hr)	Throughput (Veh/hr)	Average throughput (PCU/hr)	Throughput (exit side) (Veh/hr)	Start queue (Veh)	End queue (Veh)	Delay (s)	Unsignalised level of service
1 - Tollgate Rd (S)	393	98	0	393	404	259	0.3	0.4	3.279	A
2 - Tollgate Rd (N)	265	66	0	265	261	393	0.0	0.0	0.045	A

08:30 - 08:45

Arm	Total Demand (Veh/hr)	Junction Arrivals (Veh)	Circulating flow (Veh/hr)	Throughput (Veh/hr)	Average throughput (PCU/hr)	Throughput (exit side) (Veh/hr)	Start queue (Veh)	End queue (Veh)	Delay (s)	Unsignalised level of service
1 - Tollgate Rd (S)	496	124	0	497	490	305	0.4	0.4	3.558	A
2 - Tollgate Rd (N)	308	77	0	304	318	497	0.0	0.4	1.371	A

08:45 - 09:00

Arm	Total Demand (Veh/hr)	Junction Arrivals (Veh)	Circulating flow (Veh/hr)	Throughput (Veh/hr)	Average throughput (PCU/hr)	Throughput (exit side) (Veh/hr)	Start queue (Veh)	End queue (Veh)	Delay (s)	Unsignalised level of service
1 - Tollgate Rd (S)	491	123	0	492	498	303	0.4	0.5	3.663	A
2 - Tollgate Rd (N)	310	77	0	309	318	492	0.4	0.2	3.222	A

09:00 - 09:15

Arm	Total Demand (Veh/hr)	Junction Arrivals (Veh)	Circulating flow (Veh/hr)	Throughput (Veh/hr)	Average throughput (PCU/hr)	Throughput (exit side) (Veh/hr)	Start queue (Veh)	End queue (Veh)	Delay (s)	Unsignalised level of service
1 - Tollgate Rd (S)	403	101	0	404	406	252	0.5	0.3	3.290	A
2 - Tollgate Rd (N)	257	64	0	257	264	404	0.2	0.0	0.326	A

09:15 - 09:30

Arm	Total Demand (Veh/hr)	Junction Arrivals (Veh)	Circulating flow (Veh/hr)	Throughput (Veh/hr)	Average throughput (PCU/hr)	Throughput (exit side) (Veh/hr)	Start queue (Veh)	End queue (Veh)	Delay (s)	Unsignalised level of service
1 - Tollgate Rd (S)	327	82	0	329	341	214	0.3	0.2	3.068	A
2 - Tollgate Rd (N)	212	53	0	212	222	329	0.0	0.0	0.063	A

Lane Results

Lane Level notation: Lane Level 1 is always closest to the junction.

Lanes: Main Results for each time segment

08:00 - 08:15

Arm	Side	Lane level	Lane	Destination arms	Total Demand (Veh/hr)	Capacity (Veh/hr)	RFC	Throughput (Veh/hr)	Average throughput (PCU/hr)	Start queue (Veh)	End queue (Veh)	Delay (s)	Unsignalised level of service
1 - Tollgate Rd (S)	Entry	1	1	1, 2	323	98085	0.003	323	337	0.0	0.0	0.037	A
		2	1	(1, 2)	322			323	337	0.0	0.3	3.020	A
	Exit	1	1		218			219	220	0.0	0.6	11.090	B
		2	1		219			219	220	0.0	0.0	0.000	A
2 - Tollgate Rd (N)	Entry	1	1	1, 2	218	97816	0.002	218	222	0.0	0.0	0.036	A
	Exit	1	1		323			323	337	0.0	0.0	0.000	A

08:15 - 08:30

Arm	Side	Lane level	Lane	Destination arms	Total Demand (Veh/hr)	Capacity (Veh/hr)	RFC	Throughput (Veh/hr)	Average throughput (PCU/hr)	Start queue (Veh)	End queue (Veh)	Delay (s)	Unsignalised level of service
1 - Tollgate Rd (S)	Entry	1	1	1, 2	393	97956	0.004	393	404	0.0	0.0	0.037	A
		2	1	(1, 2)	393			393	404	0.3	0.4	3.243	A
	Exit	1	1		265			259	257	0.6	1.6	17.274	C
		2	1		259			259	257	0.0	0.0	0.000	A
2 - Tollgate Rd (N)	Entry	1	1	1, 2	265	97766	0.003	265	261	0.0	0.0	0.045	A
	Exit	1	1		393			393	404	0.0	0.0	0.000	A

08:30 - 08:45

Arm	Side	Lane level	Lane	Destination arms	Total Demand (Veh/hr)	Capacity (Veh/hr)	RFC	Throughput (Veh/hr)	Average throughput (PCU/hr)	Start queue (Veh)	End queue (Veh)	Delay (s)	Unsignalised level of service
1 - Tollgate Rd (S)	Entry	1	1	1, 2	498	98147	0.005	497	490	0.0	0.0	0.037	A
		2	1	(1, 2)	496			498	490	0.4	0.4	3.521	A
	Exit	1	1		304			305	313	1.6	2.8	31.783	D
		2	1		305			305	313	0.0	0.0	0.000	A
2 - Tollgate Rd (N)	Entry	1	1	1, 2	308	97223	0.003	304	318	0.0	0.4	1.371	A
	Exit	1	1		497			497	490	0.0	0.0	0.000	A

08:45 - 09:00

Arm	Side	Lane level	Lane	Destination arms	Total Demand (Veh/hr)	Capacity (Veh/hr)	RFC	Throughput (Veh/hr)	Average throughput (PCU/hr)	Start queue (Veh)	End queue (Veh)	Delay (s)	Unsignalised level of service
1 - Tollgate Rd (S)	Entry	1	1	1, 2	492	98274	0.005	492	498	0.0	0.0	0.036	A
		2	1	(1, 2)	491			492	498	0.4	0.5	3.626	A
	Exit	1	1		309			303	316	2.8	3.2	36.264	E
		2	1		303			303	316	0.0	0.0	0.000	A
2 - Tollgate Rd (N)	Entry	1	1	1, 2	310	97446	0.003	309	318	0.4	0.2	3.222	A
	Exit	1	1		492			492	498	0.0	0.0	0.000	A

09:00 - 09:15

Arm	Side	Lane level	Lane	Destination arms	Total Demand (Veh/hr)	Capacity (Veh/hr)	RFC	Throughput (Veh/hr)	Average throughput (PCU/hr)	Start queue (Veh)	End queue (Veh)	Delay (s)	Unsignalised level of service
1 - Tollgate Rd (S)	Entry	1	1	1, 2	404	98032	0.004	404	406	0.0	0.0	0.036	A
		2	1	(1, 2)	403			404	406	0.5	0.3	3.253	A
	Exit	1	1		257			252	272	3.2	1.3	18.111	C
		2	1		252			252	272	0.0	0.0	0.000	A
2 - Tollgate Rd (N)	Entry	1	1	1, 2	257	96257	0.003	257	264	0.2	0.0	0.326	A
	Exit	1	1		404			404	406	0.0	0.0	0.000	A

09:15 - 09:30

Arm	Side	Lane level	Lane	Destination arms	Total Demand (Veh/hr)	Capacity (Veh/hr)	RFC	Throughput (Veh/hr)	Average throughput (PCU/hr)	Start queue (Veh)	End queue (Veh)	Delay (s)	Unsignalised level of service
1 - Tollgate Rd (S)	Entry	1	1	1, 2	329	97862	0.003	329	341	0.0	0.0	0.037	A
		2	1	(1, 2)	327			329	341	0.3	0.2	3.031	A
	Exit	1	1		212			214	225	1.3	0.6	11.703	B
		2	1		214			214	225	0.0	0.0	0.000	A
2 - Tollgate Rd (N)	Entry	1	1	1, 2	212	98130	0.002	212	222	0.0	0.0	0.063	A
	Exit	1	1		329			329	341	0.0	0.0	0.000	A

Lane movements: Main Results for each time segment
08:00 - 08:15

Arm	Side	Lane level	Lane	To Arm	Total Demand (Veh/hr)	Junction Arrivals (Veh)	Simulation max flow (PCU/hr)	Capacity (Veh/hr)	RFC	Throughput (Veh/hr)	Average throughput (PCU/hr)	Start queue (Veh)	End queue (Veh)	Delay (s)	Unsignalised level of service
1 - Tollgate Rd (S)	Entry	1	1	1	0	0	0	0	0.000	0	0	0.0	0.0	0.000	A
				2	323	81	99999	98085	0.003	323	337	0.0	0.0	0.037	A
		2	1	1	0	0	0	0	0.000	0	0	0.0	0.0	0.000	A
				2	322	81	1800	1766	0.182	323	337	0.0	0.3	3.020	A
2 - Tollgate Rd (N)	Entry	1	1	1	218	55	99999	97816	0.002	218	222	0.0	0.0	0.036	A
				2	0	0	0	0	0.000	0	0	0.0	0.0	0.000	A

08:15 - 08:30

Arm	Side	Lane level	Lane	To Arm	Total Demand (Veh/hr)	Junction Arrivals (Veh)	Simulation max flow (PCU/hr)	Capacity (Veh/hr)	RFC	Throughput (Veh/hr)	Average throughput (PCU/hr)	Start queue (Veh)	End queue (Veh)	Delay (s)	Unsignalised level of service
1 - Tollgate Rd (S)	Entry	1	1	1	0	0	0	0	0.000	0	0	0.0	0.0	0.000	A
				2	393	98	99999	97956	0.004	393	404	0.0	0.0	0.037	A
		2	1	1	0	0	0	0	0.000	0	0	0.0	0.0	0.000	A
				2	393	98	1800	1763	0.223	393	404	0.3	0.4	3.243	A
2 - Tollgate Rd (N)	Entry	1	1	1	265	66	99999	97766	0.003	265	261	0.0	0.0	0.045	A
				2	0	0	0	0	0.000	0	0	0.0	0.0	0.000	A

08:30 - 08:45

Arm	Side	Lane level	Lane	To Arm	Total Demand (Veh/hr)	Junction Arrivals (Veh)	Simulation max flow (PCU/hr)	Capacity (Veh/hr)	RFC	Throughput (Veh/hr)	Average throughput (PCU/hr)	Start queue (Veh)	End queue (Veh)	Delay (s)	Unsignalised level of service
1 - Tollgate Rd (S)	Entry	1	1	1	0	0	0	0	0.000	0	0	0.0	0.0	0.000	A
				2	498	124	99999	98147	0.005	497	490	0.0	0.0	0.037	A
		2	1	1	0	0	0	0	0.000	0	0	0.0	0.0	0.000	A
				2	496	124	1800	1767	0.281	498	490	0.4	0.4	3.521	A
2 - Tollgate Rd (N)	Entry	1	1	1	308	77	99999	97223	0.003	304	318	0.0	0.4	1.371	A
				2	0	0	0	0	0.000	0	0	0.0	0.0	0.000	A

08:45 - 09:00

Arm	Side	Lane level	Lane	To Arm	Total Demand (Veh/hr)	Junction Arrivals (Veh)	Simulation max flow (PCU/hr)	Capacity (Veh/hr)	RFC	Throughput (Veh/hr)	Average throughput (PCU/hr)	Start queue (Veh)	End queue (Veh)	Delay (s)	Unsignalised level of service
1 - Tollgate Rd (S)	Entry	1	1	1	0	0	0	0	0.000	0	0	0.0	0.0	0.000	A
				2	492	123	99999	98274	0.005	492	498	0.0	0.0	0.036	A
		2	1	1	0	0	0	0	0.000	0	0	0.0	0.0	0.000	A
				2	491	123	1800	1769	0.277	492	498	0.4	0.5	3.626	A
2 - Tollgate Rd (N)	Entry	1	1	1	310	77	99999	97446	0.003	309	318	0.4	0.2	3.222	A
				2	0	0	0	0	0.000	0	0	0.0	0.0	0.000	A

09:00 - 09:15

Arm	Side	Lane level	Lane	To Arm	Total Demand (Veh/hr)	Junction Arrivals (Veh)	Simulation max flow (PCU/hr)	Capacity (Veh/hr)	RFC	Throughput (Veh/hr)	Average throughput (PCU/hr)	Start queue (Veh)	End queue (Veh)	Delay (s)	Unsignalised level of service
1 - Tollgate Rd (S)	Entry	1	1	1	0	0	0	0	0.000	0	0	0.0	0.0	0.000	A
				2	404	101	99999	98032	0.004	404	406	0.0	0.0	0.036	A
		2	1	1	0	0	0	0	0.000	0	0	0.0	0.0	0.000	A
				2	403	101	1800	1765	0.229	404	406	0.5	0.3	3.253	A
2 - Tollgate Rd (N)	Entry	1	1	1	257	64	99999	96257	0.003	257	264	0.2	0.0	0.326	A
				2	0	0	0	0	0.000	0	0	0.0	0.0	0.000	A

09:15 - 09:30

Arm	Side	Lane level	Lane	To Arm	Total Demand (Veh/hr)	Junction Arrivals (Veh)	Simulation max flow (PCU/hr)	Capacity (Veh/hr)	RFC	Throughput (Veh/hr)	Average throughput (PCU/hr)	Start queue (Veh)	End queue (Veh)	Delay (s)	Unsignalised level of service
1 - Tollgate Rd (S)	Entry	1	1	1	0	0	0	0	0.000	0	0	0.0	0.0	0.000	A
				2	329	82	99999	97862	0.003	329	341	0.0	0.0	0.037	A
		2	1	1	0	0	0	0	0.000	0	0	0.0	0.0	0.000	A
				2	327	82	1800	1762	0.186	329	341	0.3	0.2	3.031	A
2 - Tollgate Rd (N)	Entry	1	1	1	212	53	99999	98130	0.002	212	222	0.0	0.0	0.063	A
				2	0	0	0	0	0.000	0	0	0.0	0.0	0.000	A

2022 Base, PM

Data Errors and Warnings

Severity	Area	Item	Description
Info	Lane Simulation	A1 - [Lane Simulation]	This analysis set uses Lane Simulation mode. For detailed information on this mode, please see the User Guide.

Junction Network

Junctions

Junction	Name	Junction type	Use circulating lanes	Arm order	Junction Delay (s)	Junction LOS
1	Tollgate Rd	Standard Roundabout		1, 2	1.77	A

Junction Network

Driving side	Lighting	Network delay (s)	Network LOS
Left	Normal/unknown	1.77	A

Traffic Demand

Demand Set Details

ID	Scenario name	Time Period name	Traffic profile type	Start time (HH:mm)	Finish time (HH:mm)	Time segment length (min)	Run automatically
D2	2022 Base	PM	ONE HOUR	17:00	18:30	15	✓

Vehicle mix varies over turn	Vehicle mix varies over entry	Vehicle mix source	PCU Factor for a HV (PCU)
✓	✓	HV Percentages	2.00

Demand overview (Traffic)

Arm	Linked arm	Profile type	Use O-D data	Average Demand (Veh/hr)	Scaling Factor (%)
1 - Tollgate Rd (S)		ONE HOUR	✓	297	100.000
2 - Tollgate Rd (N)		ONE HOUR	✓	331	100.000

Origin-Destination Data

Demand (Veh/hr)

From	To	
	1 - Tollgate Rd (S)	2 - Tollgate Rd (N)
1 - Tollgate Rd (S)	0	297
2 - Tollgate Rd (N)	331	0

Vehicle Mix

Heavy Vehicle Percentages

From	To	
	1 - Tollgate Rd (S)	2 - Tollgate Rd (N)
1 - Tollgate Rd (S)	0	1
2 - Tollgate Rd (N)	1	0

Results

Results Summary for whole modelled period

Arm	Max Delay (s)	Max Queue (Veh)	Max LOS	Average Demand (Veh/hr)	Total Junction Arrivals (Veh)
1 - Tollgate Rd (S)	3.56	0.4	A	270	405
2 - Tollgate Rd (N)	0.19	0.0	A	305	458

Main Results for each time segment

17:00 - 17:15

Arm	Total Demand (Veh/hr)	Junction Arrivals (Veh)	Circulating flow (Veh/hr)	Throughput (Veh/hr)	Average throughput (PCU/hr)	Throughput (exit side) (Veh/hr)	Start queue (Veh)	End queue (Veh)	Delay (s)	Unsignalised level of service
1 - Tollgate Rd (S)	218	55	0	217	227	241	0.0	0.2	2.998	A
2 - Tollgate Rd (N)	242	60	0	242	252	217	0.0	0.0	0.036	A

17:15 - 17:30

Arm	Total Demand (Veh/hr)	Junction Arrivals (Veh)	Circulating flow (Veh/hr)	Throughput (Veh/hr)	Average throughput (PCU/hr)	Throughput (exit side) (Veh/hr)	Start queue (Veh)	End queue (Veh)	Delay (s)	Unsignalised level of service
1 - Tollgate Rd (S)	276	69	0	275	272	310	0.2	0.3	3.206	A
2 - Tollgate Rd (N)	310	77	0	310	306	275	0.0	0.0	0.041	A

17:30 - 17:45

Arm	Total Demand (Veh/hr)	Junction Arrivals (Veh)	Circulating flow (Veh/hr)	Throughput (Veh/hr)	Average throughput (PCU/hr)	Throughput (exit side) (Veh/hr)	Start queue (Veh)	End queue (Veh)	Delay (s)	Unsignalised level of service
1 - Tollgate Rd (S)	317	79	0	316	327	369	0.3	0.3	3.453	A
2 - Tollgate Rd (N)	366	91	0	365	370	316	0.0	0.0	0.186	A

17:45 - 18:00

Arm	Total Demand (Veh/hr)	Junction Arrivals (Veh)	Circulating flow (Veh/hr)	Throughput (Veh/hr)	Average throughput (PCU/hr)	Throughput (exit side) (Veh/hr)	Start queue (Veh)	End queue (Veh)	Delay (s)	Unsignalised level of service
1 - Tollgate Rd (S)	324	81	0	323	327	374	0.3	0.4	3.561	A
2 - Tollgate Rd (N)	374	93	0	374	375	323	0.0	0.0	0.181	A

18:00 - 18:15

Arm	Total Demand (Veh/hr)	Junction Arrivals (Veh)	Circulating flow (Veh/hr)	Throughput (Veh/hr)	Average throughput (PCU/hr)	Throughput (exit side) (Veh/hr)	Start queue (Veh)	End queue (Veh)	Delay (s)	Unsignalised level of service
1 - Tollgate Rd (S)	264	66	0	264	271	294	0.4	0.2	3.228	A
2 - Tollgate Rd (N)	293	73	0	293	304	264	0.0	0.0	0.036	A

18:15 - 18:30

Arm	Total Demand (Veh/hr)	Junction Arrivals (Veh)	Circulating flow (Veh/hr)	Throughput (Veh/hr)	Average throughput (PCU/hr)	Throughput (exit side) (Veh/hr)	Start queue (Veh)	End queue (Veh)	Delay (s)	Unsignalised level of service
1 - Tollgate Rd (S)	221	55	0	221	222	248	0.2	0.2	3.004	A
2 - Tollgate Rd (N)	249	62	0	249	254	221	0.0	0.0	0.037	A

Lane Results

Lane Level notation: Lane Level 1 is always closest to the junction.

Lanes: Main Results for each time segment

17:00 - 17:15

Arm	Side	Lane level	Lane	Destination arms	Total Demand (Veh/hr)	Capacity (Veh/hr)	RFC	Throughput (Veh/hr)	Average throughput (PCU/hr)	Start queue (Veh)	End queue (Veh)	Delay (s)	Unsignalised level of service
1 - Tollgate Rd (S)	Entry	1	1	1, 2	217	98917	0.002	217	227	0.0	0.0	0.036	A
		2	1	(1, 2)	218			217	227	0.0	0.2	2.962	A
	Exit	1	1		242			241	250	0.0	0.5	7.212	A
		2	1		241			241	250	0.0	0.0	0.000	A
2 - Tollgate Rd (N)	Entry	1	1	1, 2	242	99317	0.002	242	252	0.0	0.0	0.036	A
	Exit	1	1		217			217	227	0.0	0.0	0.000	A

17:15 - 17:30

Arm	Side	Lane level	Lane	Destination arms	Total Demand (Veh/hr)	Capacity (Veh/hr)	RFC	Throughput (Veh/hr)	Average throughput (PCU/hr)	Start queue (Veh)	End queue (Veh)	Delay (s)	Unsignalised level of service
1 - Tollgate Rd (S)	Entry	1	1	1, 2	275	98930	0.003	275	272	0.0	0.0	0.037	A
		2	1	(1, 2)	276			275	272	0.2	0.3	3.169	A
	Exit	1	1		310			310	304	0.5	1.0	10.024	B
		2	1		310			310	304	0.0	0.0	0.000	A
2 - Tollgate Rd (N)	Entry	1	1	1, 2	310	99012	0.003	310	306	0.0	0.0	0.041	A
	Exit	1	1		275			275	272	0.0	0.0	0.000	A

17:30 - 17:45

Arm	Side	Lane level	Lane	Destination arms	Total Demand (Veh/hr)	Capacity (Veh/hr)	RFC	Throughput (Veh/hr)	Average throughput (PCU/hr)	Start queue (Veh)	End queue (Veh)	Delay (s)	Unsignalised level of service
1 - Tollgate Rd (S)	Entry	1	1	1, 2	316	98958	0.003	316	327	0.0	0.0	0.035	A
		2	1	(1, 2)	317			316	327	0.3	0.3	3.418	A
	Exit	1	1		365			369	368	1.0	1.4	15.602	C
		2	1		369			369	368	0.0	0.0	0.000	A
2 - Tollgate Rd (N)	Entry	1	1	1, 2	366	99031	0.004	365	370	0.0	0.0	0.186	A
	Exit	1	1		316			316	327	0.0	0.0	0.000	A

17:45 - 18:00

Arm	Side	Lane level	Lane	Destination arms	Total Demand (Veh/hr)	Capacity (Veh/hr)	RFC	Throughput (Veh/hr)	Average throughput (PCU/hr)	Start queue (Veh)	End queue (Veh)	Delay (s)	Unsignalised level of service
1 - Tollgate Rd (S)	Entry	1	1	1, 2	323	98863	0.003	323	327	0.0	0.0	0.036	A
		2	1	(1, 2)	324			323	327	0.3	0.4	3.525	A
	Exit	1	1		374			374	374	1.4	1.7	16.258	C
		2	1		374			374	374	0.0	0.0	0.000	A
2 - Tollgate Rd (N)	Entry	1	1	1, 2	374	99335	0.004	374	375	0.0	0.0	0.181	A
	Exit	1	1		323			323	327	0.0	0.0	0.000	A

18:00 - 18:15

Arm	Side	Lane level	Lane	Destination arms	Total Demand (Veh/hr)	Capacity (Veh/hr)	RFC	Throughput (Veh/hr)	Average throughput (PCU/hr)	Start queue (Veh)	End queue (Veh)	Delay (s)	Unsignalised level of service
1 - Tollgate Rd (S)	Entry	1	1	1, 2	264	99053	0.003	264	271	0.0	0.0	0.037	A
		2	1	(1, 2)	264			264	271	0.4	0.2	3.191	A
	Exit	1	1		293			294	307	1.7	0.8	10.106	B
		2	1		294			294	307	0.0	0.0	0.000	A
2 - Tollgate Rd (N)	Entry	1	1	1, 2	293	98837	0.003	293	304	0.0	0.0	0.036	A
	Exit	1	1		264			264	271	0.0	0.0	0.000	A

18:15 - 18:30

Arm	Side	Lane level	Lane	Destination arms	Total Demand (Veh/hr)	Capacity (Veh/hr)	RFC	Throughput (Veh/hr)	Average throughput (PCU/hr)	Start queue (Veh)	End queue (Veh)	Delay (s)	Unsignalised level of service
1 - Tollgate Rd (S)	Entry	1	1	1, 2	221	99450	0.002	221	222	0.0	0.0	0.036	A
		2	1	(1, 2)	221			221	222	0.2	0.2	2.968	A
	Exit	1	1		249			248	255	0.8	0.6	7.433	A
		2	1		248			248	255	0.0	0.0	0.000	A
2 - Tollgate Rd (N)	Entry	1	1	1, 2	249	98799	0.003	249	254	0.0	0.0	0.037	A
	Exit	1	1		221			221	222	0.0	0.0	0.000	A

Lane movements: Main Results for each time segment
17:00 - 17:15

Arm	Side	Lane level	Lane	To Arm	Total Demand (Veh/hr)	Junction Arrivals (Veh)	Simulation max flow (PCU/hr)	Capacity (Veh/hr)	RFC	Throughput (Veh/hr)	Average throughput (PCU/hr)	Start queue (Veh)	End queue (Veh)	Delay (s)	Unsignalised level of service
1 - Tollgate Rd (S)	Entry	1	1	1	0	0	0	0	0.000	0	0	0.0	0.0	0.000	A
				2	217	54	99999	98917	0.002	217	227	0.0	0.0	0.036	A
		2	1	1	0	0	0	0	0.000	0	0	0.0	0.0	0.000	A
				2	218	55	1800	1781	0.123	217	227	0.0	0.2	2.962	A
2 - Tollgate Rd (N)	Entry	1	1	1	242	60	99999	99317	0.002	242	252	0.0	0.0	0.036	A
				2	0	0	0	0	0.000	0	0	0.0	0.0	0.000	A

17:15 - 17:30

Arm	Side	Lane level	Lane	To Arm	Total Demand (Veh/hr)	Junction Arrivals (Veh)	Simulation max flow (PCU/hr)	Capacity (Veh/hr)	RFC	Throughput (Veh/hr)	Average throughput (PCU/hr)	Start queue (Veh)	End queue (Veh)	Delay (s)	Unsignalised level of service
1 - Tollgate Rd (S)	Entry	1	1	1	0	0	0	0	0.000	0	0	0.0	0.0	0.000	A
				2	275	69	99999	98930	0.003	275	272	0.0	0.0	0.037	A
		2	1	1	0	0	0	0	0.000	0	0	0.0	0.0	0.000	A
				2	276	69	1800	1781	0.155	275	272	0.2	0.3	3.169	A
2 - Tollgate Rd (N)	Entry	1	1	1	310	77	99999	99012	0.003	310	306	0.0	0.0	0.041	A
				2	0	0	0	0	0.000	0	0	0.0	0.0	0.000	A

17:30 - 17:45

Arm	Side	Lane level	Lane	To Arm	Total Demand (Veh/hr)	Junction Arrivals (Veh)	Simulation max flow (PCU/hr)	Capacity (Veh/hr)	RFC	Throughput (Veh/hr)	Average throughput (PCU/hr)	Start queue (Veh)	End queue (Veh)	Delay (s)	Unsignalised level of service
1 - Tollgate Rd (S)	Entry	1	1	1	0	0	0	0	0.000	0	0	0.0	0.0	0.000	A
				2	316	79	99999	98958	0.003	316	327	0.0	0.0	0.035	A
		2	1	1	0	0	0	0	0.000	0	0	0.0	0.0	0.000	A
				2	317	79	1800	1781	0.178	316	327	0.3	0.3	3.418	A
2 - Tollgate Rd (N)	Entry	1	1	1	366	91	99999	99031	0.004	365	370	0.0	0.0	0.186	A
				2	0	0	0	0	0.000	0	0	0.0	0.0	0.000	A

17:45 - 18:00

Arm	Side	Lane level	Lane	To Arm	Total Demand (Veh/hr)	Junction Arrivals (Veh)	Simulation max flow (PCU/hr)	Capacity (Veh/hr)	RFC	Throughput (Veh/hr)	Average throughput (PCU/hr)	Start queue (Veh)	End queue (Veh)	Delay (s)	Unsignalised level of service
1 - Tollgate Rd (S)	Entry	1	1	1	0	0	0	0	0.000	0	0	0.0	0.0	0.000	A
				2	323	81	99999	98863	0.003	323	327	0.0	0.0	0.036	A
		2	1	1	0	0	0	0	0.000	0	0	0.0	0.0	0.000	A
				2	324	81	1800	1780	0.182	323	327	0.3	0.4	3.525	A
2 - Tollgate Rd (N)	Entry	1	1	1	374	93	99999	99335	0.004	374	375	0.0	0.0	0.181	A
				2	0	0	0	0	0.000	0	0	0.0	0.0	0.000	A

18:00 - 18:15

Arm	Side	Lane level	Lane	To Arm	Total Demand (Veh/hr)	Junction Arrivals (Veh)	Simulation max flow (PCU/hr)	Capacity (Veh/hr)	RFC	Throughput (Veh/hr)	Average throughput (PCU/hr)	Start queue (Veh)	End queue (Veh)	Delay (s)	Unsignalised level of service
1 - Tollgate Rd (S)	Entry	1	1	1	0	0	0	0	0.000	0	0	0.0	0.0	0.000	A
				2	264	66	99999	99053	0.003	264	271	0.0	0.0	0.037	A
		2	1	1	0	0	0	0	0.000	0	0	0.0	0.0	0.000	A
				2	264	66	1800	1783	0.148	264	271	0.4	0.2	3.191	A
2 - Tollgate Rd (N)	Entry	1	1	1	293	73	99999	98837	0.003	293	304	0.0	0.0	0.036	A
				2	0	0	0	0	0.000	0	0	0.0	0.0	0.000	A

18:15 - 18:30

Arm	Side	Lane level	Lane	To Arm	Total Demand (Veh/hr)	Junction Arrivals (Veh)	Simulation max flow (PCU/hr)	Capacity (Veh/hr)	RFC	Throughput (Veh/hr)	Average throughput (PCU/hr)	Start queue (Veh)	End queue (Veh)	Delay (s)	Unsignalised level of service
1 - Tollgate Rd (S)	Entry	1	1	1	0	0	0	0	0.000	0	0	0.0	0.0	0.000	A
				2	221	55	99999	99450	0.002	221	222	0.0	0.0	0.036	A
		2	1	1	0	0	0	0	0.000	0	0	0.0	0.0	0.000	A
				2	221	55	1800	1790	0.124	221	222	0.2	0.2	2.968	A
2 - Tollgate Rd (N)	Entry	1	1	1	249	62	99999	98799	0.003	249	254	0.0	0.0	0.037	A
				2	0	0	0	0	0.000	0	0	0.0	0.0	0.000	A

2027 Base, AM

Data Errors and Warnings

Severity	Area	Item	Description
Info	Lane Simulation	A1 - [Lane Simulation]	This analysis set uses Lane Simulation mode. For detailed information on this mode, please see the User Guide.

Junction Network

Junctions

Junction	Name	Junction type	Use circulating lanes	Arm order	Junction Delay (s)	Junction LOS
1	Tollgate Rd	Standard Roundabout		1, 2	4.19	A

Junction Network

Driving side	Lighting	Network delay (s)	Network LOS
Left	Normal/unknown	4.19	A

Traffic Demand

Demand Set Details

ID	Scenario name	Time Period name	Traffic profile type	Start time (HH:mm)	Finish time (HH:mm)	Time segment length (min)	Run automatically
D3	2027 Base	AM	ONE HOUR	08:00	09:30	15	✓

Vehicle mix varies over turn	Vehicle mix varies over entry	Vehicle mix source	PCU Factor for a HV (PCU)
✓	✓	HV Percentages	2.00

Demand overview (Traffic)

Arm	Linked arm	Profile type	Use O-D data	Average Demand (Veh/hr)	Scaling Factor (%)
1 - Tollgate Rd (S)		ONE HOUR	✓	448	100.000
2 - Tollgate Rd (N)		ONE HOUR	✓	287	100.000

Origin-Destination Data

Demand (Veh/hr)

From	To	
	1 - Tollgate Rd (S)	2 - Tollgate Rd (N)
1 - Tollgate Rd (S)	0	448
2 - Tollgate Rd (N)	287	0

Vehicle Mix

Heavy Vehicle Percentages

From	To	
	1 - Tollgate Rd (S)	2 - Tollgate Rd (N)
1 - Tollgate Rd (S)	0	2
2 - Tollgate Rd (N)	3	0

Results

Results Summary for whole modelled period

Arm	Max Delay (s)	Max Queue (Veh)	Max LOS	Average Demand (Veh/hr)	Total Junction Arrivals (Veh)
1 - Tollgate Rd (S)	3.65	0.5	A	409	613
2 - Tollgate Rd (N)	5.02	0.6	A	262	394

Main Results for each time segment

08:00 - 08:15

Arm	Total Demand (Veh/hr)	Junction Arrivals (Veh)	Circulating flow (Veh/hr)	Throughput (Veh/hr)	Average throughput (PCU/hr)	Throughput (exit side) (Veh/hr)	Start queue (Veh)	End queue (Veh)	Delay (s)	Unsignalised level of service
1 - Tollgate Rd (S)	328	82	0	327	346	206	0.0	0.3	3.077	A
2 - Tollgate Rd (N)	207	52	0	207	222	327	0.0	0.0	0.037	A

08:15 - 08:30

Arm	Total Demand (Veh/hr)	Junction Arrivals (Veh)	Circulating flow (Veh/hr)	Throughput (Veh/hr)	Average throughput (PCU/hr)	Throughput (exit side) (Veh/hr)	Start queue (Veh)	End queue (Veh)	Delay (s)	Unsignalised level of service
1 - Tollgate Rd (S)	399	100	0	400	406	261	0.3	0.3	3.302	A
2 - Tollgate Rd (N)	261	65	0	261	267	400	0.0	0.0	0.114	A

08:30 - 08:45

Arm	Total Demand (Veh/hr)	Junction Arrivals (Veh)	Circulating flow (Veh/hr)	Throughput (Veh/hr)	Average throughput (PCU/hr)	Throughput (exit side) (Veh/hr)	Start queue (Veh)	End queue (Veh)	Delay (s)	Unsignalised level of service
1 - Tollgate Rd (S)	498	125	0	500	508	326	0.3	0.4	3.600	A
2 - Tollgate Rd (N)	325	81	0	322	326	500	0.0	0.6	3.641	A

08:45 - 09:00

Arm	Total Demand (Veh/hr)	Junction Arrivals (Veh)	Circulating flow (Veh/hr)	Throughput (Veh/hr)	Average throughput (PCU/hr)	Throughput (exit side) (Veh/hr)	Start queue (Veh)	End queue (Veh)	Delay (s)	Unsignalised level of service
1 - Tollgate Rd (S)	490	122	0	490	503	322	0.4	0.5	3.649	A
2 - Tollgate Rd (N)	313	78	0	314	324	490	0.6	0.4	5.018	A

09:00 - 09:15

Arm	Total Demand (Veh/hr)	Junction Arrivals (Veh)	Circulating flow (Veh/hr)	Throughput (Veh/hr)	Average throughput (PCU/hr)	Throughput (exit side) (Veh/hr)	Start queue (Veh)	End queue (Veh)	Delay (s)	Unsignalised level of service
1 - Tollgate Rd (S)	401	100	0	401	403	255	0.5	0.4	3.336	A
2 - Tollgate Rd (N)	255	64	0	255	271	401	0.4	0.0	0.259	A

09:15 - 09:30

Arm	Total Demand (Veh/hr)	Junction Arrivals (Veh)	Circulating flow (Veh/hr)	Throughput (Veh/hr)	Average throughput (PCU/hr)	Throughput (exit side) (Veh/hr)	Start queue (Veh)	End queue (Veh)	Delay (s)	Unsignalised level of service
1 - Tollgate Rd (S)	335	84	0	333	343	213	0.4	0.3	3.053	A
2 - Tollgate Rd (N)	213	53	0	213	223	333	0.0	0.0	0.052	A

Lane Results

Lane Level notation: Lane Level 1 is always closest to the junction.

Lanes: Main Results for each time segment

08:00 - 08:15

Arm	Side	Lane level	Lane	Destination arms	Total Demand (Veh/hr)	Capacity (Veh/hr)	RFC	Throughput (Veh/hr)	Average throughput (PCU/hr)	Start queue (Veh)	End queue (Veh)	Delay (s)	Unsignalised level of service
1 - Tollgate Rd (S)	Entry	1	1	1, 2	327	97982	0.003	327	346	0.0	0.0	0.037	A
		2	1	(1, 2)	328			327	346	0.0	0.3	3.041	A
	Exit	1	1		207			206	218	0.0	0.8	11.584	B
		2	1		206			206	218	0.0	0.0	0.000	A
2 - Tollgate Rd (N)	Entry	1	1	1, 2	207	97262	0.002	207	222	0.0	0.0	0.037	A
	Exit	1	1		327			327	346	0.0	0.0	0.000	A

08:15 - 08:30

Arm	Side	Lane level	Lane	Destination arms	Total Demand (Veh/hr)	Capacity (Veh/hr)	RFC	Throughput (Veh/hr)	Average throughput (PCU/hr)	Start queue (Veh)	End queue (Veh)	Delay (s)	Unsignalised level of service
1 - Tollgate Rd (S)	Entry	1	1	1, 2	400	97934	0.004	400	406	0.0	0.0	0.037	A
		2	1	(1, 2)	399			400	406	0.3	0.3	3.265	A
	Exit	1	1		261			261	266	0.8	1.1	17.369	C
		2	1		261			261	266	0.0	0.0	0.000	A
2 - Tollgate Rd (N)	Entry	1	1	1, 2	261	97169	0.003	261	267	0.0	0.0	0.114	A
	Exit	1	1		400			400	406	0.0	0.0	0.000	A

08:30 - 08:45

Arm	Side	Lane level	Lane	Destination arms	Total Demand (Veh/hr)	Capacity (Veh/hr)	RFC	Throughput (Veh/hr)	Average throughput (PCU/hr)	Start queue (Veh)	End queue (Veh)	Delay (s)	Unsignalised level of service
1 - Tollgate Rd (S)	Entry	1	1	1, 2	499	98241	0.005	500	508	0.0	0.0	0.037	A
		2	1	(1, 2)	498			499	508	0.3	0.4	3.563	A
	Exit	1	1		322			326	317	1.1	3.3	37.167	E
		2	1		326			326	317	0.0	0.0	0.000	A
2 - Tollgate Rd (N)	Entry	1	1	1, 2	325	97199	0.003	322	326	0.0	0.6	3.641	A
	Exit	1	1		500			500	508	0.0	0.0	0.000	A

08:45 - 09:00

Arm	Side	Lane level	Lane	Destination arms	Total Demand (Veh/hr)	Capacity (Veh/hr)	RFC	Throughput (Veh/hr)	Average throughput (PCU/hr)	Start queue (Veh)	End queue (Veh)	Delay (s)	Unsignalised level of service
1 - Tollgate Rd (S)	Entry	1	1	1, 2	490	97982	0.005	490	503	0.0	0.0	0.037	A
		2	1	(1, 2)	490			490	503	0.4	0.5	3.613	A
	Exit	1	1		314			322	327	3.3	2.8	38.595	E
		2	1		322			322	327	0.0	0.0	0.000	A
2 - Tollgate Rd (N)	Entry	1	1	1, 2	313	97201	0.003	314	324	0.6	0.4	5.018	A
	Exit	1	1		490			490	503	0.0	0.0	0.000	A

09:00 - 09:15

Arm	Side	Lane level	Lane	Destination arms	Total Demand (Veh/hr)	Capacity (Veh/hr)	RFC	Throughput (Veh/hr)	Average throughput (PCU/hr)	Start queue (Veh)	End queue (Veh)	Delay (s)	Unsignalised level of service
1 - Tollgate Rd (S)	Entry	1	1	1, 2	401	97906	0.004	401	403	0.0	0.0	0.037	A
		2	1	(1, 2)	401			401	403	0.5	0.4	3.299	A
	Exit	1	1		255			255	278	2.8	1.0	17.710	C
		2	1		255			255	278	0.0	0.0	0.000	A
2 - Tollgate Rd (N)	Entry	1	1	1, 2	255	97644	0.003	255	271	0.4	0.0	0.259	A
	Exit	1	1		401			401	403	0.0	0.0	0.000	A

09:15 - 09:30

Arm	Side	Lane level	Lane	Destination arms	Total Demand (Veh/hr)	Capacity (Veh/hr)	RFC	Throughput (Veh/hr)	Average throughput (PCU/hr)	Start queue (Veh)	End queue (Veh)	Delay (s)	Unsignalised level of service
1 - Tollgate Rd (S)	Entry	1	1	1, 2	333	97870	0.003	333	343	0.0	0.0	0.037	A
		2	1	(1, 2)	335			333	343	0.4	0.3	3.016	A
	Exit	1	1		213			213	224	1.0	0.6	11.833	B
		2	1		213			213	224	0.0	0.0	0.000	A
2 - Tollgate Rd (N)	Entry	1	1	1, 2	213	96553	0.002	213	223	0.0	0.0	0.052	A
	Exit	1	1		333			333	343	0.0	0.0	0.000	A

Lane movements: Main Results for each time segment
08:00 - 08:15

Arm	Side	Lane level	Lane	To Arm	Total Demand (Veh/hr)	Junction Arrivals (Veh)	Simulation max flow (PCU/hr)	Capacity (Veh/hr)	RFC	Throughput (Veh/hr)	Average throughput (PCU/hr)	Start queue (Veh)	End queue (Veh)	Delay (s)	Unsignalised level of service
1 - Tollgate Rd (S)	Entry	1	1	1	0	0	0	0	0.000	0	0	0.0	0.0	0.000	A
				2	327	82	99999	97982	0.003	327	346	0.0	0.0	0.037	A
		2	1	1	0	0	0	0	0.000	0	0	0.0	0.0	0.000	A
				2	328	82	1800	1764	0.186	327	346	0.0	0.3	3.041	A
2 - Tollgate Rd (N)	Entry	1	1	1	207	52	99999	97262	0.002	207	222	0.0	0.0	0.037	A
				2	0	0	0	0	0.000	0	0	0.0	0.0	0.000	A

08:15 - 08:30

Arm	Side	Lane level	Lane	To Arm	Total Demand (Veh/hr)	Junction Arrivals (Veh)	Simulation max flow (PCU/hr)	Capacity (Veh/hr)	RFC	Throughput (Veh/hr)	Average throughput (PCU/hr)	Start queue (Veh)	End queue (Veh)	Delay (s)	Unsignalised level of service
1 - Tollgate Rd (S)	Entry	1	1	1	0	0	0	0	0.000	0	0	0.0	0.0	0.000	A
				2	400	100	99999	97934	0.004	400	406	0.0	0.0	0.037	A
		2	1	1	0	0	0	0	0.000	0	0	0.0	0.0	0.000	A
				2	399	100	1800	1763	0.227	400	406	0.3	0.3	3.265	A
2 - Tollgate Rd (N)	Entry	1	1	1	261	65	99999	97169	0.003	261	267	0.0	0.0	0.114	A
				2	0	0	0	0	0.000	0	0	0.0	0.0	0.000	A

08:30 - 08:45

Arm	Side	Lane level	Lane	To Arm	Total Demand (Veh/hr)	Junction Arrivals (Veh)	Simulation max flow (PCU/hr)	Capacity (Veh/hr)	RFC	Throughput (Veh/hr)	Average throughput (PCU/hr)	Start queue (Veh)	End queue (Veh)	Delay (s)	Unsignalised level of service
1 - Tollgate Rd (S)	Entry	1	1	1	0	0	0	0	0.000	0	0	0.0	0.0	0.000	A
				2	499	125	99999	98241	0.005	500	508	0.0	0.0	0.037	A
		2	1	1	0	0	0	0	0.000	0	0	0.0	0.0	0.000	A
				2	498	125	1800	1768	0.282	499	508	0.3	0.4	3.563	A
2 - Tollgate Rd (N)	Entry	1	1	1	325	81	99999	97199	0.003	322	326	0.0	0.6	3.641	A
				2	0	0	0	0	0.000	0	0	0.0	0.0	0.000	A

08:45 - 09:00

Arm	Side	Lane level	Lane	To Arm	Total Demand (Veh/hr)	Junction Arrivals (Veh)	Simulation max flow (PCU/hr)	Capacity (Veh/hr)	RFC	Throughput (Veh/hr)	Average throughput (PCU/hr)	Start queue (Veh)	End queue (Veh)	Delay (s)	Unsignalised level of service
1 - Tollgate Rd (S)	Entry	1	1	1	0	0	0	0	0.000	0	0	0.0	0.0	0.000	A
				2	490	123	99999	97982	0.005	490	503	0.0	0.0	0.037	A
		2	1	1	0	0	0	0	0.000	0	0	0.0	0.0	0.000	A
				2	490	122	1800	1764	0.278	490	503	0.4	0.5	3.613	A
2 - Tollgate Rd (N)	Entry	1	1	1	313	78	99999	97201	0.003	314	324	0.6	0.4	5.018	A
				2	0	0	0	0	0.000	0	0	0.0	0.0	0.000	A

09:00 - 09:15

Arm	Side	Lane level	Lane	To Arm	Total Demand (Veh/hr)	Junction Arrivals (Veh)	Simulation max flow (PCU/hr)	Capacity (Veh/hr)	RFC	Throughput (Veh/hr)	Average throughput (PCU/hr)	Start queue (Veh)	End queue (Veh)	Delay (s)	Unsignalised level of service
1 - Tollgate Rd (S)	Entry	1	1	1	0	0	0	0	0.000	0	0	0.0	0.0	0.000	A
				2	401	100	99999	97906	0.004	401	403	0.0	0.0	0.037	A
		2	1	1	0	0	0	0	0.000	0	0	0.0	0.0	0.000	A
				2	401	100	1800	1762	0.228	401	403	0.5	0.4	3.299	A
2 - Tollgate Rd (N)	Entry	1	1	1	255	64	99999	97644	0.003	255	271	0.4	0.0	0.259	A
				2	0	0	0	0	0.000	0	0	0.0	0.0	0.000	A

09:15 - 09:30

Arm	Side	Lane level	Lane	To Arm	Total Demand (Veh/hr)	Junction Arrivals (Veh)	Simulation max flow (PCU/hr)	Capacity (Veh/hr)	RFC	Throughput (Veh/hr)	Average throughput (PCU/hr)	Start queue (Veh)	End queue (Veh)	Delay (s)	Unsignalised level of service
1 - Tollgate Rd (S)	Entry	1	1	1	0	0	0	0	0.000	0	0	0.0	0.0	0.000	A
				2	333	83	99999	97870	0.003	333	343	0.0	0.0	0.037	A
		2	1	1	0	0	0	0	0.000	0	0	0.0	0.0	0.000	A
				2	335	84	1800	1762	0.190	333	343	0.4	0.3	3.016	A
2 - Tollgate Rd (N)	Entry	1	1	1	213	53	99999	96553	0.002	213	223	0.0	0.0	0.052	A
				2	0	0	0	0	0.000	0	0	0.0	0.0	0.000	A

2027 Base, PM

Data Errors and Warnings

Severity	Area	Item	Description
Info	Lane Simulation	A1 - [Lane Simulation]	This analysis set uses Lane Simulation mode. For detailed information on this mode, please see the User Guide.

Junction Network

Junctions

Junction	Name	Junction type	Use circulating lanes	Arm order	Junction Delay (s)	Junction LOS
1	Tollgate Rd	Standard Roundabout		1, 2	1.88	A

Junction Network

Driving side	Lighting	Network delay (s)	Network LOS
Left	Normal/unknown	1.88	A

Traffic Demand

Demand Set Details

ID	Scenario name	Time Period name	Traffic profile type	Start time (HH:mm)	Finish time (HH:mm)	Time segment length (min)	Run automatically
D4	2027 Base	PM	ONE HOUR	17:00	18:30	15	✓

Vehicle mix varies over turn	Vehicle mix varies over entry	Vehicle mix source	PCU Factor for a HV (PCU)
✓	✓	HV Percentages	2.00

Demand overview (Traffic)

Arm	Linked arm	Profile type	Use O-D data	Average Demand (Veh/hr)	Scaling Factor (%)
1 - Tollgate Rd (S)		ONE HOUR	✓	302	100.000
2 - Tollgate Rd (N)		ONE HOUR	✓	336	100.000

Origin-Destination Data

Demand (Veh/hr)

From	To	
	1 - Tollgate Rd (S)	2 - Tollgate Rd (N)
1 - Tollgate Rd (S)	0	302
2 - Tollgate Rd (N)	336	0

Vehicle Mix

Heavy Vehicle Percentages

From	To	
	1 - Tollgate Rd (S)	2 - Tollgate Rd (N)
1 - Tollgate Rd (S)	0	1
2 - Tollgate Rd (N)	1	0

Results

Results Summary for whole modelled period

Arm	Max Delay (s)	Max Queue (Veh)	Max LOS	Average Demand (Veh/hr)	Total Junction Arrivals (Veh)
1 - Tollgate Rd (S)	3.47	0.4	A	278	417
2 - Tollgate Rd (N)	0.45	0.0	A	311	466

Main Results for each time segment

17:00 - 17:15

Arm	Total Demand (Veh/hr)	Junction Arrivals (Veh)	Circulating flow (Veh/hr)	Throughput (Veh/hr)	Average throughput (PCU/hr)	Throughput (exit side) (Veh/hr)	Start queue (Veh)	End queue (Veh)	Delay (s)	Unsignalised level of service
1 - Tollgate Rd (S)	221	55	0	222	228	251	0.0	0.1	2.983	A
2 - Tollgate Rd (N)	250	62	0	250	258	222	0.0	0.0	0.036	A

17:15 - 17:30

Arm	Total Demand (Veh/hr)	Junction Arrivals (Veh)	Circulating flow (Veh/hr)	Throughput (Veh/hr)	Average throughput (PCU/hr)	Throughput (exit side) (Veh/hr)	Start queue (Veh)	End queue (Veh)	Delay (s)	Unsignalised level of service
1 - Tollgate Rd (S)	277	69	0	278	275	314	0.1	0.2	3.239	A
2 - Tollgate Rd (N)	313	78	0	313	310	278	0.0	0.0	0.039	A

17:30 - 17:45

Arm	Total Demand (Veh/hr)	Junction Arrivals (Veh)	Circulating flow (Veh/hr)	Throughput (Veh/hr)	Average throughput (PCU/hr)	Throughput (exit side) (Veh/hr)	Start queue (Veh)	End queue (Veh)	Delay (s)	Unsignalised level of service
1 - Tollgate Rd (S)	337	84	0	336	334	372	0.2	0.3	3.431	A
2 - Tollgate Rd (N)	376	94	0	376	375	336	0.0	0.0	0.451	A

17:45 - 18:00

Arm	Total Demand (Veh/hr)	Junction Arrivals (Veh)	Circulating flow (Veh/hr)	Throughput (Veh/hr)	Average throughput (PCU/hr)	Throughput (exit side) (Veh/hr)	Start queue (Veh)	End queue (Veh)	Delay (s)	Unsignalised level of service
1 - Tollgate Rd (S)	320	80	0	319	336	373	0.3	0.3	3.469	A
2 - Tollgate Rd (N)	374	93	0	373	373	319	0.0	0.0	0.169	A

18:00 - 18:15

Arm	Total Demand (Veh/hr)	Junction Arrivals (Veh)	Circulating flow (Veh/hr)	Throughput (Veh/hr)	Average throughput (PCU/hr)	Throughput (exit side) (Veh/hr)	Start queue (Veh)	End queue (Veh)	Delay (s)	Unsignalised level of service
1 - Tollgate Rd (S)	282	71	0	282	279	296	0.3	0.2	3.243	A
2 - Tollgate Rd (N)	297	74	0	297	304	282	0.0	0.0	0.037	A

18:15 - 18:30

Arm	Total Demand (Veh/hr)	Junction Arrivals (Veh)	Circulating flow (Veh/hr)	Throughput (Veh/hr)	Average throughput (PCU/hr)	Throughput (exit side) (Veh/hr)	Start queue (Veh)	End queue (Veh)	Delay (s)	Unsignalised level of service
1 - Tollgate Rd (S)	229	57	0	230	234	254	0.2	0.2	2.967	A
2 - Tollgate Rd (N)	254	64	0	254	258	230	0.0	0.0	0.036	A

Lane Results

Lane Level notation: Lane Level 1 is always closest to the junction.

Lanes: Main Results for each time segment

17:00 - 17:15

Arm	Side	Lane level	Lane	Destination arms	Total Demand (Veh/hr)	Capacity (Veh/hr)	RFC	Throughput (Veh/hr)	Average throughput (PCU/hr)	Start queue (Veh)	End queue (Veh)	Delay (s)	Unsignalised level of service
1 - Tollgate Rd (S)	Entry	1	1	1, 2	222	98928	0.002	222	228	0.0	0.0	0.037	A
		2	1	(1, 2)	221			222	228	0.0	0.1	2.946	A
	Exit	1	1		250			251	257	0.0	0.4	7.651	A
		2	1		251			251	257	0.0	0.0	0.000	A
2 - Tollgate Rd (N)	Entry	1	1	1, 2	250	98953	0.003	250	258	0.0	0.0	0.036	A
	Exit	1	1		222			222	228	0.0	0.0	0.000	A

17:15 - 17:30

Arm	Side	Lane level	Lane	Destination arms	Total Demand (Veh/hr)	Capacity (Veh/hr)	RFC	Throughput (Veh/hr)	Average throughput (PCU/hr)	Start queue (Veh)	End queue (Veh)	Delay (s)	Unsignalised level of service
1 - Tollgate Rd (S)	Entry	1	1	1, 2	278	98940	0.003	278	275	0.0	0.0	0.036	A
		2	1	(1, 2)	277			278	275	0.1	0.2	3.203	A
	Exit	1	1		313			314	309	0.4	0.8	10.499	B
		2	1		314			314	309	0.0	0.0	0.000	A
2 - Tollgate Rd (N)	Entry	1	1	1, 2	313	99088	0.003	313	310	0.0	0.0	0.039	A
	Exit	1	1		278			278	275	0.0	0.0	0.000	A

17:30 - 17:45

Arm	Side	Lane level	Lane	Destination arms	Total Demand (Veh/hr)	Capacity (Veh/hr)	RFC	Throughput (Veh/hr)	Average throughput (PCU/hr)	Start queue (Veh)	End queue (Veh)	Delay (s)	Unsignalised level of service
1 - Tollgate Rd (S)	Entry	1	1	1, 2	336	99262	0.003	336	334	0.0	0.0	0.036	A
		2	1	(1, 2)	337			336	334	0.2	0.3	3.395	A
	Exit	1	1		376			372	370	0.8	1.9	16.861	C
		2	1		372			372	370	0.0	0.0	0.000	A
2 - Tollgate Rd (N)	Entry	1	1	1, 2	376	98875	0.004	376	375	0.0	0.0	0.451	A
	Exit	1	1		336			336	334	0.0	0.0	0.000	A

17:45 - 18:00

Arm	Side	Lane level	Lane	Destination arms	Total Demand (Veh/hr)	Capacity (Veh/hr)	RFC	Throughput (Veh/hr)	Average throughput (PCU/hr)	Start queue (Veh)	End queue (Veh)	Delay (s)	Unsignalised level of service
1 - Tollgate Rd (S)	Entry	1	1	1, 2	319	98956	0.003	319	336	0.0	0.0	0.037	A
		2	1	(1, 2)	320			319	336	0.3	0.3	3.432	A
	Exit	1	1		373			373	375	1.9	1.5	16.091	C
		2	1		373			373	375	0.0	0.0	0.000	A
2 - Tollgate Rd (N)	Entry	1	1	1, 2	374	98825	0.004	373	373	0.0	0.0	0.169	A
	Exit	1	1		319			319	336	0.0	0.0	0.000	A

18:00 - 18:15

Arm	Side	Lane level	Lane	Destination arms	Total Demand (Veh/hr)	Capacity (Veh/hr)	RFC	Throughput (Veh/hr)	Average throughput (PCU/hr)	Start queue (Veh)	End queue (Veh)	Delay (s)	Unsignalised level of service
1 - Tollgate Rd (S)	Entry	1	1	1, 2	282	98987	0.003	282	279	0.0	0.0	0.036	A
		2	1	(1, 2)	282			282	279	0.3	0.2	3.207	A
	Exit	1	1		297			296	306	1.5	1.0	9.867	A
		2	1		296			296	306	0.0	0.0	0.000	A
2 - Tollgate Rd (N)	Entry	1	1	1, 2	297	98697	0.003	297	304	0.0	0.0	0.037	A
	Exit	1	1		282			282	279	0.0	0.0	0.000	A

18:15 - 18:30

Arm	Side	Lane level	Lane	Destination arms	Total Demand (Veh/hr)	Capacity (Veh/hr)	RFC	Throughput (Veh/hr)	Average throughput (PCU/hr)	Start queue (Veh)	End queue (Veh)	Delay (s)	Unsignalised level of service
1 - Tollgate Rd (S)	Entry	1	1	1, 2	230	98673	0.002	230	234	0.0	0.0	0.037	A
		2	1	(1, 2)	229			230	234	0.2	0.2	2.930	A
	Exit	1	1		254			254	260	1.0	0.7	7.755	A
		2	1		254			254	260	0.0	0.0	0.000	A
2 - Tollgate Rd (N)	Entry	1	1	1, 2	254	98981	0.003	254	258	0.0	0.0	0.036	A
	Exit	1	1		230			230	234	0.0	0.0	0.000	A

Lane movements: Main Results for each time segment
17:00 - 17:15

Arm	Side	Lane level	Lane	To Arm	Total Demand (Veh/hr)	Junction Arrivals (Veh)	Simulation max flow (PCU/hr)	Capacity (Veh/hr)	RFC	Throughput (Veh/hr)	Average throughput (PCU/hr)	Start queue (Veh)	End queue (Veh)	Delay (s)	Unsignalised level of service
1 - Tollgate Rd (S)	Entry	1	1	1	0	0	0	0	0.000	0	0	0.0	0.0	0.000	A
				2	222	55	99999	98928	0.002	222	228	0.0	0.0	0.037	A
		2	1	1	0	0	0	0	0.000	0	0	0.0	0.0	0.000	A
				2	221	55	1800	1781	0.124	222	228	0.0	0.1	2.946	A
2 - Tollgate Rd (N)	Entry	1	1	1	250	62	99999	98953	0.003	250	258	0.0	0.0	0.036	A
				2	0	0	0	0	0.000	0	0	0.0	0.0	0.000	A

17:15 - 17:30

Arm	Side	Lane level	Lane	To Arm	Total Demand (Veh/hr)	Junction Arrivals (Veh)	Simulation max flow (PCU/hr)	Capacity (Veh/hr)	RFC	Throughput (Veh/hr)	Average throughput (PCU/hr)	Start queue (Veh)	End queue (Veh)	Delay (s)	Unsignalised level of service
1 - Tollgate Rd (S)	Entry	1	1	1	0	0	0	0	0.000	0	0	0.0	0.0	0.000	A
				2	278	69	99999	98940	0.003	278	275	0.0	0.0	0.036	A
		2	1	1	0	0	0	0	0.000	0	0	0.0	0.0	0.000	A
				2	277	69	1800	1781	0.156	278	275	0.1	0.2	3.203	A
2 - Tollgate Rd (N)	Entry	1	1	1	313	78	99999	99088	0.003	313	310	0.0	0.0	0.039	A
				2	0	0	0	0	0.000	0	0	0.0	0.0	0.000	A

17:30 - 17:45

Arm	Side	Lane level	Lane	To Arm	Total Demand (Veh/hr)	Junction Arrivals (Veh)	Simulation max flow (PCU/hr)	Capacity (Veh/hr)	RFC	Throughput (Veh/hr)	Average throughput (PCU/hr)	Start queue (Veh)	End queue (Veh)	Delay (s)	Unsignalised level of service
1 - Tollgate Rd (S)	Entry	1	1	1	0	0	0	0	0.000	0	0	0.0	0.0	0.000	A
				2	336	84	99999	99262	0.003	336	334	0.0	0.0	0.036	A
		2	1	1	0	0	0	0	0.000	0	0	0.0	0.0	0.000	A
				2	337	84	1800	1787	0.189	336	334	0.2	0.3	3.395	A
2 - Tollgate Rd (N)	Entry	1	1	1	376	94	99999	98875	0.004	376	375	0.0	0.0	0.451	A
				2	0	0	0	0	0.000	0	0	0.0	0.0	0.000	A

17:45 - 18:00

Arm	Side	Lane level	Lane	To Arm	Total Demand (Veh/hr)	Junction Arrivals (Veh)	Simulation max flow (PCU/hr)	Capacity (Veh/hr)	RFC	Throughput (Veh/hr)	Average throughput (PCU/hr)	Start queue (Veh)	End queue (Veh)	Delay (s)	Unsignalised level of service
1 - Tollgate Rd (S)	Entry	1	1	1	0	0	0	0	0.000	0	0	0.0	0.0	0.000	A
				2	319	80	99999	98956	0.003	319	336	0.0	0.0	0.037	A
		2	1	1	0	0	0	0	0.000	0	0	0.0	0.0	0.000	A
				2	320	80	1800	1781	0.180	319	336	0.3	0.3	3.432	A
2 - Tollgate Rd (N)	Entry	1	1	1	374	93	99999	98825	0.004	373	373	0.0	0.0	0.169	A
				2	0	0	0	0	0.000	0	0	0.0	0.0	0.000	A

18:00 - 18:15

Arm	Side	Lane level	Lane	To Arm	Total Demand (Veh/hr)	Junction Arrivals (Veh)	Simulation max flow (PCU/hr)	Capacity (Veh/hr)	RFC	Throughput (Veh/hr)	Average throughput (PCU/hr)	Start queue (Veh)	End queue (Veh)	Delay (s)	Unsignalised level of service
1 - Tollgate Rd (S)	Entry	1	1	1	0	0	0	0	0.000	0	0	0.0	0.0	0.000	A
				2	282	70	99999	98987	0.003	282	279	0.0	0.0	0.036	A
		2	1	1	0	0	0	0	0.000	0	0	0.0	0.0	0.000	A
				2	282	71	1800	1782	0.158	282	279	0.3	0.2	3.207	A
2 - Tollgate Rd (N)	Entry	1	1	1	297	74	99999	98697	0.003	297	304	0.0	0.0	0.037	A
				2	0	0	0	0	0.000	0	0	0.0	0.0	0.000	A

18:15 - 18:30

Arm	Side	Lane level	Lane	To Arm	Total Demand (Veh/hr)	Junction Arrivals (Veh)	Simulation max flow (PCU/hr)	Capacity (Veh/hr)	RFC	Throughput (Veh/hr)	Average throughput (PCU/hr)	Start queue (Veh)	End queue (Veh)	Delay (s)	Unsignalised level of service
1 - Tollgate Rd (S)	Entry	1	1	1	0	0	0	0	0.000	0	0	0.0	0.0	0.000	A
				2	230	58	99999	98673	0.002	230	234	0.0	0.0	0.037	A
		2	1	1	0	0	0	0	0.000	0	0	0.0	0.0	0.000	A
				2	229	57	1800	1776	0.129	230	234	0.2	0.2	2.930	A
2 - Tollgate Rd (N)	Entry	1	1	1	254	64	99999	98981	0.003	254	258	0.0	0.0	0.036	A
				2	0	0	0	0	0.000	0	0	0.0	0.0	0.000	A

2027 Base + Dev, AM

Data Errors and Warnings

Severity	Area	Item	Description
Info	Lane Simulation	A1 - [Lane Simulation]	This analysis set uses Lane Simulation mode. For detailed information on this mode, please see the User Guide.

Junction Network

Junctions

Junction	Name	Junction type	Use circulating lanes	Arm order	Junction Delay (s)	Junction LOS
1	Tollgate Rd	Standard Roundabout		1, 2	5.50	A

Junction Network

Driving side	Lighting	Network delay (s)	Network LOS
Left	Normal/unknown	5.50	A

Traffic Demand

Demand Set Details

ID	Scenario name	Time Period name	Traffic profile type	Start time (HH:mm)	Finish time (HH:mm)	Time segment length (min)	Run automatically
D5	2027 Base + Dev	AM	ONE HOUR	08:00	09:30	15	✓

Vehicle mix varies over turn	Vehicle mix varies over entry	Vehicle mix source	PCU Factor for a HV (PCU)
✓	✓	HV Percentages	2.00

Demand overview (Traffic)

Arm	Linked arm	Profile type	Use O-D data	Average Demand (Veh/hr)	Scaling Factor (%)
1 - Tollgate Rd (S)		ONE HOUR	✓	454	100.000
2 - Tollgate Rd (N)		ONE HOUR	✓	302	100.000

Origin-Destination Data

Demand (Veh/hr)

From	To	
	1 - Tollgate Rd (S)	2 - Tollgate Rd (N)
1 - Tollgate Rd (S)	0	454
2 - Tollgate Rd (N)	302	0

Vehicle Mix

Heavy Vehicle Percentages

From	To	
	1 - Tollgate Rd (S)	2 - Tollgate Rd (N)
1 - Tollgate Rd (S)	0	2
2 - Tollgate Rd (N)	3	0

Results

Results Summary for whole modelled period

Arm	Max Delay (s)	Max Queue (Veh)	Max LOS	Average Demand (Veh/hr)	Total Junction Arrivals (Veh)
1 - Tollgate Rd (S)	3.69	0.5	A	420	630
2 - Tollgate Rd (N)	8.22	1.0	A	275	413

Main Results for each time segment

08:00 - 08:15

Arm	Total Demand (Veh/hr)	Junction Arrivals (Veh)	Circulating flow (Veh/hr)	Throughput (Veh/hr)	Average throughput (PCU/hr)	Throughput (exit side) (Veh/hr)	Start queue (Veh)	End queue (Veh)	Delay (s)	Unsignalised level of service
1 - Tollgate Rd (S)	348	87	0	348	357	227	0.0	0.3	3.076	A
2 - Tollgate Rd (N)	228	57	0	228	235	348	0.0	0.0	0.039	A

08:15 - 08:30

Arm	Total Demand (Veh/hr)	Junction Arrivals (Veh)	Circulating flow (Veh/hr)	Throughput (Veh/hr)	Average throughput (PCU/hr)	Throughput (exit side) (Veh/hr)	Start queue (Veh)	End queue (Veh)	Delay (s)	Unsignalised level of service
1 - Tollgate Rd (S)	411	103	0	412	420	270	0.3	0.4	3.311	A
2 - Tollgate Rd (N)	275	69	0	275	283	412	0.0	0.0	0.220	A

08:30 - 08:45

Arm	Total Demand (Veh/hr)	Junction Arrivals (Veh)	Circulating flow (Veh/hr)	Throughput (Veh/hr)	Average throughput (PCU/hr)	Throughput (exit side) (Veh/hr)	Start queue (Veh)	End queue (Veh)	Delay (s)	Unsignalised level of service
1 - Tollgate Rd (S)	509	127	0	511	512	326	0.4	0.5	3.670	A
2 - Tollgate Rd (N)	338	85	0	333	338	511	0.0	1.0	5.267	A

08:45 - 09:00

Arm	Total Demand (Veh/hr)	Junction Arrivals (Veh)	Circulating flow (Veh/hr)	Throughput (Veh/hr)	Average throughput (PCU/hr)	Throughput (exit side) (Veh/hr)	Start queue (Veh)	End queue (Veh)	Delay (s)	Unsignalised level of service
1 - Tollgate Rd (S)	501	125	0	500	507	318	0.5	0.5	3.692	A
2 - Tollgate Rd (N)	324	81	0	323	340	500	1.0	0.6	8.223	A

09:00 - 09:15

Arm	Total Demand (Veh/hr)	Junction Arrivals (Veh)	Circulating flow (Veh/hr)	Throughput (Veh/hr)	Average throughput (PCU/hr)	Throughput (exit side) (Veh/hr)	Start queue (Veh)	End queue (Veh)	Delay (s)	Unsignalised level of service
1 - Tollgate Rd (S)	409	102	0	410	416	271	0.5	0.4	3.374	A
2 - Tollgate Rd (N)	264	66	0	264	273	410	0.6	0.0	0.666	A

09:15 - 09:30

Arm	Total Demand (Veh/hr)	Junction Arrivals (Veh)	Circulating flow (Veh/hr)	Throughput (Veh/hr)	Average throughput (PCU/hr)	Throughput (exit side) (Veh/hr)	Start queue (Veh)	End queue (Veh)	Delay (s)	Unsignalised level of service
1 - Tollgate Rd (S)	340	85	0	340	347	223	0.4	0.3	3.105	A
2 - Tollgate Rd (N)	222	55	0	222	231	340	0.0	0.0	0.065	A

Lane Results

Lane Level notation: Lane Level 1 is always closest to the junction.

Lanes: Main Results for each time segment

08:00 - 08:15

Arm	Side	Lane level	Lane	Destination arms	Total Demand (Veh/hr)	Capacity (Veh/hr)	RFC	Throughput (Veh/hr)	Average throughput (PCU/hr)	Start queue (Veh)	End queue (Veh)	Delay (s)	Unsignalised level of service
1 - Tollgate Rd (S)	Entry	1	1	1, 2	347	97825	0.004	348	357	0.0	0.0	0.037	A
		2	1	(1, 2)	348			347	357	0.0	0.3	3.039	A
	Exit	1	1		228			227	232	0.0	0.8	11.798	B
		2	1		227			227	232	0.0	0.0	0.000	A
2 - Tollgate Rd (N)	Entry	1	1	1, 2	228	96787	0.002	228	235	0.0	0.0	0.039	A
	Exit	1	1		348			348	357	0.0	0.0	0.000	A

08:15 - 08:30

Arm	Side	Lane level	Lane	Destination arms	Total Demand (Veh/hr)	Capacity (Veh/hr)	RFC	Throughput (Veh/hr)	Average throughput (PCU/hr)	Start queue (Veh)	End queue (Veh)	Delay (s)	Unsignalised level of service
1 - Tollgate Rd (S)	Entry	1	1	1, 2	411	98213	0.004	412	420	0.0	0.0	0.037	A
		2	1	(1, 2)	411			411	420	0.3	0.4	3.275	A
	Exit	1	1		275			270	279	0.8	1.9	20.034	C
		2	1		270			270	279	0.0	0.0	0.000	A
2 - Tollgate Rd (N)	Entry	1	1	1, 2	275	96701	0.003	275	283	0.0	0.0	0.220	A
	Exit	1	1		412			412	420	0.0	0.0	0.000	A

08:30 - 08:45

Arm	Side	Lane level	Lane	Destination arms	Total Demand (Veh/hr)	Capacity (Veh/hr)	RFC	Throughput (Veh/hr)	Average throughput (PCU/hr)	Start queue (Veh)	End queue (Veh)	Delay (s)	Unsignalised level of service
1 - Tollgate Rd (S)	Entry	1	1	1, 2	511	98354	0.005	511	512	0.0	0.0	0.037	A
		2	1	(1, 2)	509			511	512	0.4	0.5	3.634	A
	Exit	1	1		333			326	329	1.9	4.1	39.888	E
		2	1		326			326	329	0.0	0.0	0.000	A
2 - Tollgate Rd (N)	Entry	1	1	1, 2	338	97461	0.003	333	338	0.0	1.0	5.267	A
	Exit	1	1		511			511	512	0.0	0.0	0.000	A

08:45 - 09:00

Arm	Side	Lane level	Lane	Destination arms	Total Demand (Veh/hr)	Capacity (Veh/hr)	RFC	Throughput (Veh/hr)	Average throughput (PCU/hr)	Start queue (Veh)	End queue (Veh)	Delay (s)	Unsignalised level of service
1 - Tollgate Rd (S)	Entry	1	1	1, 2	500	98019	0.005	500	507	0.0	0.0	0.037	A
		2	1	(1, 2)	501			500	507	0.5	0.5	3.655	A
	Exit	1	1		323			318	340	4.1	4.0	41.384	E
		2	1		318			318	340	0.0	0.0	0.000	A
2 - Tollgate Rd (N)	Entry	1	1	1, 2	324	96864	0.003	323	340	1.0	0.6	8.223	A
	Exit	1	1		500			500	507	0.0	0.0	0.000	A

09:00 - 09:15

Arm	Side	Lane level	Lane	Destination arms	Total Demand (Veh/hr)	Capacity (Veh/hr)	RFC	Throughput (Veh/hr)	Average throughput (PCU/hr)	Start queue (Veh)	End queue (Veh)	Delay (s)	Unsignalised level of service
1 - Tollgate Rd (S)	Entry	1	1	1, 2	410	98236	0.004	410	416	0.0	0.0	0.036	A
		2	1	(1, 2)	409			410	416	0.5	0.4	3.337	A
	Exit	1	1		264			271	285	4.0	1.0	20.125	C
		2	1		271			271	285	0.0	0.0	0.000	A
2 - Tollgate Rd (N)	Entry	1	1	1, 2	264	97159	0.003	264	273	0.6	0.0	0.666	A
	Exit	1	1		410			410	416	0.0	0.0	0.000	A

09:15 - 09:30

Arm	Side	Lane level	Lane	Destination arms	Total Demand (Veh/hr)	Capacity (Veh/hr)	RFC	Throughput (Veh/hr)	Average throughput (PCU/hr)	Start queue (Veh)	End queue (Veh)	Delay (s)	Unsignalised level of service
1 - Tollgate Rd (S)	Entry	1	1	1, 2	340	98317	0.003	340	347	0.0	0.0	0.036	A
		2	1	(1, 2)	340			340	347	0.4	0.3	3.069	A
	Exit	1	1		222			223	232	1.0	0.8	12.487	B
		2	1		223			223	232	0.0	0.0	0.000	A
2 - Tollgate Rd (N)	Entry	1	1	1, 2	222	97111	0.002	222	231	0.0	0.0	0.065	A
	Exit	1	1		340			340	347	0.0	0.0	0.000	A

Lane movements: Main Results for each time segment
08:00 - 08:15

Arm	Side	Lane level	Lane	To Arm	Total Demand (Veh/hr)	Junction Arrivals (Veh)	Simulation max flow (PCU/hr)	Capacity (Veh/hr)	RFC	Throughput (Veh/hr)	Average throughput (PCU/hr)	Start queue (Veh)	End queue (Veh)	Delay (s)	Unsignalised level of service
1 - Tollgate Rd (S)	Entry	1	1	1	0	0	0	0	0.000	0	0	0.0	0.0	0.000	A
				2	347	87	99999	97825	0.004	348	357	0.0	0.0	0.037	A
		2	1	1	0	0	0	0	0.000	0	0	0.0	0.0	0.000	A
				2	348	87	1800	1761	0.197	347	357	0.0	0.3	3.039	A
2 - Tollgate Rd (N)	Entry	1	1	1	228	57	99999	96787	0.002	228	235	0.0	0.0	0.039	A
				2	0	0	0	0	0.000	0	0	0.0	0.0	0.000	A

08:15 - 08:30

Arm	Side	Lane level	Lane	To Arm	Total Demand (Veh/hr)	Junction Arrivals (Veh)	Simulation max flow (PCU/hr)	Capacity (Veh/hr)	RFC	Throughput (Veh/hr)	Average throughput (PCU/hr)	Start queue (Veh)	End queue (Veh)	Delay (s)	Unsignalised level of service
1 - Tollgate Rd (S)	Entry	1	1	1	0	0	0	0	0.000	0	0	0.0	0.0	0.000	A
				2	411	103	99999	98213	0.004	412	420	0.0	0.0	0.037	A
		2	1	1	0	0	0	0	0.000	0	0	0.0	0.0	0.000	A
				2	411	103	1800	1768	0.232	411	420	0.3	0.4	3.275	A
2 - Tollgate Rd (N)	Entry	1	1	1	275	69	99999	96701	0.003	275	283	0.0	0.0	0.220	A
				2	0	0	0	0	0.000	0	0	0.0	0.0	0.000	A

08:30 - 08:45

Arm	Side	Lane level	Lane	To Arm	Total Demand (Veh/hr)	Junction Arrivals (Veh)	Simulation max flow (PCU/hr)	Capacity (Veh/hr)	RFC	Throughput (Veh/hr)	Average throughput (PCU/hr)	Start queue (Veh)	End queue (Veh)	Delay (s)	Unsignalised level of service
1 - Tollgate Rd (S)	Entry	1	1	1	0	0	0	0	0.000	0	0	0.0	0.0	0.000	A
				2	511	128	99999	98354	0.005	511	512	0.0	0.0	0.037	A
		2	1	1	0	0	0	0	0.000	0	0	0.0	0.0	0.000	A
				2	509	127	1800	1770	0.288	511	512	0.4	0.5	3.634	A
2 - Tollgate Rd (N)	Entry	1	1	1	338	85	99999	97461	0.003	333	338	0.0	1.0	5.267	A
				2	0	0	0	0	0.000	0	0	0.0	0.0	0.000	A

08:45 - 09:00

Arm	Side	Lane level	Lane	To Arm	Total Demand (Veh/hr)	Junction Arrivals (Veh)	Simulation max flow (PCU/hr)	Capacity (Veh/hr)	RFC	Throughput (Veh/hr)	Average throughput (PCU/hr)	Start queue (Veh)	End queue (Veh)	Delay (s)	Unsignalised level of service
1 - Tollgate Rd (S)	Entry	1	1	1	0	0	0	0	0.000	0	0	0.0	0.0	0.000	A
				2	500	125	99999	98019	0.005	500	507	0.0	0.0	0.037	A
		2	1	1	0	0	0	0	0.000	0	0	0.0	0.0	0.000	A
				2	501	125	1800	1764	0.284	500	507	0.5	0.5	3.655	A
2 - Tollgate Rd (N)	Entry	1	1	1	324	81	99999	96864	0.003	323	340	1.0	0.6	8.223	A
				2	0	0	0	0	0.000	0	0	0.0	0.0	0.000	A

09:00 - 09:15

Arm	Side	Lane level	Lane	To Arm	Total Demand (Veh/hr)	Junction Arrivals (Veh)	Simulation max flow (PCU/hr)	Capacity (Veh/hr)	RFC	Throughput (Veh/hr)	Average throughput (PCU/hr)	Start queue (Veh)	End queue (Veh)	Delay (s)	Unsignalised level of service
1 - Tollgate Rd (S)	Entry	1	1	1	0	0	0	0	0.000	0	0	0.0	0.0	0.000	A
				2	410	103	99999	98236	0.004	410	416	0.0	0.0	0.036	A
		2	1	1	0	0	0	0	0.000	0	0	0.0	0.0	0.000	A
				2	409	102	1800	1768	0.231	410	416	0.5	0.4	3.337	A
2 - Tollgate Rd (N)	Entry	1	1	1	264	66	99999	97159	0.003	264	273	0.6	0.0	0.666	A
				2	0	0	0	0	0.000	0	0	0.0	0.0	0.000	A

09:15 - 09:30

Arm	Side	Lane level	Lane	To Arm	Total Demand (Veh/hr)	Junction Arrivals (Veh)	Simulation max flow (PCU/hr)	Capacity (Veh/hr)	RFC	Throughput (Veh/hr)	Average throughput (PCU/hr)	Start queue (Veh)	End queue (Veh)	Delay (s)	Unsignalised level of service
1 - Tollgate Rd (S)	Entry	1	1	1	0	0	0	0	0.000	0	0	0.0	0.0	0.000	A
				2	340	85	99999	98317	0.003	340	347	0.0	0.0	0.036	A
		2	1	1	0	0	0	0	0.000	0	0	0.0	0.0	0.000	A
				2	340	85	1800	1770	0.192	340	347	0.4	0.3	3.069	A
2 - Tollgate Rd (N)	Entry	1	1	1	222	55	99999	97111	0.002	222	231	0.0	0.0	0.065	A
				2	0	0	0	0	0.000	0	0	0.0	0.0	0.000	A

2027 Base + Dev, PM

Data Errors and Warnings

Severity	Area	Item	Description
Info	Lane Simulation	A1 - [Lane Simulation]	This analysis set uses Lane Simulation mode. For detailed information on this mode, please see the User Guide.

Junction Network

Junctions

Junction	Name	Junction type	Use circulating lanes	Arm order	Junction Delay (s)	Junction LOS
1	Tollgate Rd	Standard Roundabout		1, 2	1.88	A

Junction Network

Driving side	Lighting	Network delay (s)	Network LOS
Left	Normal/unknown	1.88	A

Traffic Demand

Demand Set Details

ID	Scenario name	Time Period name	Traffic profile type	Start time (HH:mm)	Finish time (HH:mm)	Time segment length (min)	Run automatically
D6	2027 Base + Dev	PM	ONE HOUR	17:00	18:30	15	✓

Vehicle mix varies over turn	Vehicle mix varies over entry	Vehicle mix source	PCU Factor for a HV (PCU)
✓	✓	HV Percentages	2.00

Demand overview (Traffic)

Arm	Linked arm	Profile type	Use O-D data	Average Demand (Veh/hr)	Scaling Factor (%)
1 - Tollgate Rd (S)		ONE HOUR	✓	315	100.000
2 - Tollgate Rd (N)		ONE HOUR	✓	345	100.000

Origin-Destination Data

Demand (Veh/hr)

From	To	
	1 - Tollgate Rd (S)	2 - Tollgate Rd (N)
1 - Tollgate Rd (S)	0	315
2 - Tollgate Rd (N)	345	0

Vehicle Mix

Heavy Vehicle Percentages

From	To	
	1 - Tollgate Rd (S)	2 - Tollgate Rd (N)
1 - Tollgate Rd (S)	0	1
2 - Tollgate Rd (N)	1	0

Results

Results Summary for whole modelled period

Arm	Max Delay (s)	Max Queue (Veh)	Max LOS	Average Demand (Veh/hr)	Total Junction Arrivals (Veh)
1 - Tollgate Rd (S)	3.52	0.3	A	289	433
2 - Tollgate Rd (N)	0.41	0.0	A	321	481

Main Results for each time segment

17:00 - 17:15

Arm	Total Demand (Veh/hr)	Junction Arrivals (Veh)	Circulating flow (Veh/hr)	Throughput (Veh/hr)	Average throughput (PCU/hr)	Throughput (exit side) (Veh/hr)	Start queue (Veh)	End queue (Veh)	Delay (s)	Unsignalised level of service
1 - Tollgate Rd (S)	238	60	0	239	243	262	0.0	0.2	2.994	A
2 - Tollgate Rd (N)	262	65	0	262	266	239	0.0	0.0	0.040	A

17:15 - 17:30

Arm	Total Demand (Veh/hr)	Junction Arrivals (Veh)	Circulating flow (Veh/hr)	Throughput (Veh/hr)	Average throughput (PCU/hr)	Throughput (exit side) (Veh/hr)	Start queue (Veh)	End queue (Veh)	Delay (s)	Unsignalised level of service
1 - Tollgate Rd (S)	282	71	0	284	283	297	0.2	0.2	3.193	A
2 - Tollgate Rd (N)	296	74	0	296	308	284	0.0	0.0	0.037	A

17:30 - 17:45

Arm	Total Demand (Veh/hr)	Junction Arrivals (Veh)	Circulating flow (Veh/hr)	Throughput (Veh/hr)	Average throughput (PCU/hr)	Throughput (exit side) (Veh/hr)	Start queue (Veh)	End queue (Veh)	Delay (s)	Unsignalised level of service
1 - Tollgate Rd (S)	350	87	0	351	349	384	0.2	0.2	3.516	A
2 - Tollgate Rd (N)	386	97	0	387	383	351	0.0	0.0	0.409	A

17:45 - 18:00

Arm	Total Demand (Veh/hr)	Junction Arrivals (Veh)	Circulating flow (Veh/hr)	Throughput (Veh/hr)	Average throughput (PCU/hr)	Throughput (exit side) (Veh/hr)	Start queue (Veh)	End queue (Veh)	Delay (s)	Unsignalised level of service
1 - Tollgate Rd (S)	345	86	0	346	347	388	0.2	0.3	3.507	A
2 - Tollgate Rd (N)	387	97	0	388	388	346	0.0	0.0	0.289	A

18:00 - 18:15

Arm	Total Demand (Veh/hr)	Junction Arrivals (Veh)	Circulating flow (Veh/hr)	Throughput (Veh/hr)	Average throughput (PCU/hr)	Throughput (exit side) (Veh/hr)	Start queue (Veh)	End queue (Veh)	Delay (s)	Unsignalised level of service
1 - Tollgate Rd (S)	285	71	0	285	288	312	0.3	0.3	3.279	A
2 - Tollgate Rd (N)	313	78	0	313	314	285	0.0	0.0	0.050	A

18:15 - 18:30

Arm	Total Demand (Veh/hr)	Junction Arrivals (Veh)	Circulating flow (Veh/hr)	Throughput (Veh/hr)	Average throughput (PCU/hr)	Throughput (exit side) (Veh/hr)	Start queue (Veh)	End queue (Veh)	Delay (s)	Unsignalised level of service
1 - Tollgate Rd (S)	232	58	0	233	241	279	0.3	0.2	3.084	A
2 - Tollgate Rd (N)	280	70	0	280	271	233	0.0	0.0	0.037	A

Lane Results

Lane Level notation: Lane Level 1 is always closest to the junction.

Lanes: Main Results for each time segment

17:00 - 17:15

Arm	Side	Lane level	Lane	Destination arms	Total Demand (Veh/hr)	Capacity (Veh/hr)	RFC	Throughput (Veh/hr)	Average throughput (PCU/hr)	Start queue (Veh)	End queue (Veh)	Delay (s)	Unsignalised level of service
1 - Tollgate Rd (S)	Entry	1	1	1, 2	239	99407	0.002	239	243	0.0	0.0	0.036	A
		2	1	(1, 2)	238			239	243	0.0	0.2	2.957	A
	Exit	1	1		262			262	264	0.0	0.5	7.892	A
		2	1		262			262	264	0.0	0.0	0.000	A
2 - Tollgate Rd (N)	Entry	1	1	1, 2	262	98878	0.003	262	266	0.0	0.0	0.040	A
	Exit	1	1		239			239	243	0.0	0.0	0.000	A

17:15 - 17:30

Arm	Side	Lane level	Lane	Destination arms	Total Demand (Veh/hr)	Capacity (Veh/hr)	RFC	Throughput (Veh/hr)	Average throughput (PCU/hr)	Start queue (Veh)	End queue (Veh)	Delay (s)	Unsignalised level of service
1 - Tollgate Rd (S)	Entry	1	1	1, 2	284	99569	0.003	284	283	0.0	0.0	0.036	A
		2	1	(1, 2)	282			284	283	0.2	0.2	3.157	A
	Exit	1	1		296			297	306	0.5	0.8	10.647	B
		2	1		297			297	306	0.0	0.0	0.000	A
2 - Tollgate Rd (N)	Entry	1	1	1, 2	296	98914	0.003	296	308	0.0	0.0	0.037	A
	Exit	1	1		284			284	283	0.0	0.0	0.000	A

17:30 - 17:45

Arm	Side	Lane level	Lane	Destination arms	Total Demand (Veh/hr)	Capacity (Veh/hr)	RFC	Throughput (Veh/hr)	Average throughput (PCU/hr)	Start queue (Veh)	End queue (Veh)	Delay (s)	Unsignalised level of service
1 - Tollgate Rd (S)	Entry	1	1	1, 2	351	99394	0.004	351	349	0.0	0.0	0.037	A
		2	1	(1, 2)	350			351	349	0.2	0.2	3.480	A
	Exit	1	1		387			384	378	0.8	2.1	17.984	C
		2	1		384			384	378	0.0	0.0	0.000	A
2 - Tollgate Rd (N)	Entry	1	1	1, 2	386	98900	0.004	387	383	0.0	0.0	0.409	A
	Exit	1	1		351			351	349	0.0	0.0	0.000	A

17:45 - 18:00

Arm	Side	Lane level	Lane	Destination arms	Total Demand (Veh/hr)	Capacity (Veh/hr)	RFC	Throughput (Veh/hr)	Average throughput (PCU/hr)	Start queue (Veh)	End queue (Veh)	Delay (s)	Unsignalised level of service
1 - Tollgate Rd (S)	Entry	1	1	1, 2	346	99182	0.003	346	347	0.0	0.0	0.037	A
		2	1	(1, 2)	345			346	347	0.2	0.3	3.470	A
	Exit	1	1		388			388	389	2.1	2.0	17.749	C
		2	1		388			388	389	0.0	0.0	0.000	A
2 - Tollgate Rd (N)	Entry	1	1	1, 2	387	98878	0.004	388	388	0.0	0.0	0.289	A
	Exit	1	1		346			346	347	0.0	0.0	0.000	A

18:00 - 18:15

Arm	Side	Lane level	Lane	Destination arms	Total Demand (Veh/hr)	Capacity (Veh/hr)	RFC	Throughput (Veh/hr)	Average throughput (PCU/hr)	Start queue (Veh)	End queue (Veh)	Delay (s)	Unsignalised level of service
1 - Tollgate Rd (S)	Entry	1	1	1, 2	285	99132	0.003	285	288	0.0	0.0	0.036	A
		2	1	(1, 2)	285			285	288	0.3	0.3	3.243	A
	Exit	1	1		313			312	318	2.0	1.1	11.325	B
		2	1		312			312	318	0.0	0.0	0.000	A
2 - Tollgate Rd (N)	Entry	1	1	1, 2	313	99219	0.003	313	314	0.0	0.0	0.050	A
	Exit	1	1		285			285	288	0.0	0.0	0.000	A

18:15 - 18:30

Arm	Side	Lane level	Lane	Destination arms	Total Demand (Veh/hr)	Capacity (Veh/hr)	RFC	Throughput (Veh/hr)	Average throughput (PCU/hr)	Start queue (Veh)	End queue (Veh)	Delay (s)	Unsignalised level of service
1 - Tollgate Rd (S)	Entry	1	1	1, 2	233	99079	0.002	233	241	0.0	0.0	0.036	A
		2	1	(1, 2)	232			233	241	0.3	0.2	3.047	A
	Exit	1	1		280			279	273	1.1	0.7	8.419	A
		2	1		279			279	273	0.0	0.0	0.000	A
2 - Tollgate Rd (N)	Entry	1	1	1, 2	280	99282	0.003	280	271	0.0	0.0	0.037	A
	Exit	1	1		233			233	241	0.0	0.0	0.000	A

Lane movements: Main Results for each time segment
17:00 - 17:15

Arm	Side	Lane level	Lane	To Arm	Total Demand (Veh/hr)	Junction Arrivals (Veh)	Simulation max flow (PCU/hr)	Capacity (Veh/hr)	RFC	Throughput (Veh/hr)	Average throughput (PCU/hr)	Start queue (Veh)	End queue (Veh)	Delay (s)	Unsignalised level of service
1 - Tollgate Rd (S)	Entry	1	1	1	0	0	0	0	0.000	0	0	0.0	0.0	0.000	A
				2	239	60	99999	99407	0.002	239	243	0.0	0.0	0.036	A
		2	1	1	0	0	0	0	0.000	0	0	0.0	0.0	0.000	A
				2	238	60	1800	1789	0.133	239	243	0.0	0.2	2.957	A
2 - Tollgate Rd (N)	Entry	1	1	1	262	65	99999	98878	0.003	262	266	0.0	0.0	0.040	A
				2	0	0	0	0	0.000	0	0	0.0	0.0	0.000	A

17:15 - 17:30

Arm	Side	Lane level	Lane	To Arm	Total Demand (Veh/hr)	Junction Arrivals (Veh)	Simulation max flow (PCU/hr)	Capacity (Veh/hr)	RFC	Throughput (Veh/hr)	Average throughput (PCU/hr)	Start queue (Veh)	End queue (Veh)	Delay (s)	Unsignalised level of service
1 - Tollgate Rd (S)	Entry	1	1	1	0	0	0	0	0.000	0	0	0.0	0.0	0.000	A
				2	284	71	99999	99569	0.003	284	283	0.0	0.0	0.036	A
		2	1	1	0	0	0	0	0.000	0	0	0.0	0.0	0.000	A
				2	282	71	1800	1792	0.158	284	283	0.2	0.2	3.157	A
2 - Tollgate Rd (N)	Entry	1	1	1	296	74	99999	98914	0.003	296	308	0.0	0.0	0.037	A
				2	0	0	0	0	0.000	0	0	0.0	0.0	0.000	A

17:30 - 17:45

Arm	Side	Lane level	Lane	To Arm	Total Demand (Veh/hr)	Junction Arrivals (Veh)	Simulation max flow (PCU/hr)	Capacity (Veh/hr)	RFC	Throughput (Veh/hr)	Average throughput (PCU/hr)	Start queue (Veh)	End queue (Veh)	Delay (s)	Unsignalised level of service
1 - Tollgate Rd (S)	Entry	1	1	1	0	0	0	0	0.000	0	0	0.0	0.0	0.000	A
				2	351	88	99999	99394	0.004	351	349	0.0	0.0	0.037	A
		2	1	1	0	0	0	0	0.000	0	0	0.0	0.0	0.000	A
				2	350	87	1800	1789	0.195	351	349	0.2	0.2	3.480	A
2 - Tollgate Rd (N)	Entry	1	1	1	386	97	99999	98900	0.004	387	383	0.0	0.0	0.409	A
				2	0	0	0	0	0.000	0	0	0.0	0.0	0.000	A

17:45 - 18:00

Arm	Side	Lane level	Lane	To Arm	Total Demand (Veh/hr)	Junction Arrivals (Veh)	Simulation max flow (PCU/hr)	Capacity (Veh/hr)	RFC	Throughput (Veh/hr)	Average throughput (PCU/hr)	Start queue (Veh)	End queue (Veh)	Delay (s)	Unsignalised level of service
1 - Tollgate Rd (S)	Entry	1	1	1	0	0	0	0	0.000	0	0	0.0	0.0	0.000	A
				2	346	86	99999	99182	0.003	346	347	0.0	0.0	0.037	A
		2	1	1	0	0	0	0	0.000	0	0	0.0	0.0	0.000	A
				2	345	86	1800	1785	0.193	346	347	0.2	0.3	3.470	A
2 - Tollgate Rd (N)	Entry	1	1	1	387	97	99999	98878	0.004	388	388	0.0	0.0	0.289	A
				2	0	0	0	0	0.000	0	0	0.0	0.0	0.000	A

18:00 - 18:15

Arm	Side	Lane level	Lane	To Arm	Total Demand (Veh/hr)	Junction Arrivals (Veh)	Simulation max flow (PCU/hr)	Capacity (Veh/hr)	RFC	Throughput (Veh/hr)	Average throughput (PCU/hr)	Start queue (Veh)	End queue (Veh)	Delay (s)	Unsignalised level of service
1 - Tollgate Rd (S)	Entry	1	1	1	0	0	0	0	0.000	0	0	0.0	0.0	0.000	A
				2	285	71	99999	99132	0.003	285	288	0.0	0.0	0.036	A
		2	1	1	0	0	0	0	0.000	0	0	0.0	0.0	0.000	A
				2	285	71	1800	1784	0.160	285	288	0.3	0.3	3.243	A
2 - Tollgate Rd (N)	Entry	1	1	1	313	78	99999	99219	0.003	313	314	0.0	0.0	0.050	A
				2	0	0	0	0	0.000	0	0	0.0	0.0	0.000	A

18:15 - 18:30

Arm	Side	Lane level	Lane	To Arm	Total Demand (Veh/hr)	Junction Arrivals (Veh)	Simulation max flow (PCU/hr)	Capacity (Veh/hr)	RFC	Throughput (Veh/hr)	Average throughput (PCU/hr)	Start queue (Veh)	End queue (Veh)	Delay (s)	Unsignalised level of service
1 - Tollgate Rd (S)	Entry	1	1	1	0	0	0	0	0.000	0	0	0.0	0.0	0.000	A
				2	233	58	99999	99079	0.002	233	241	0.0	0.0	0.036	A
		2	1	1	0	0	0	0	0.000	0	0	0.0	0.0	0.000	A
				2	232	58	1800	1783	0.130	233	241	0.3	0.2	3.047	A
2 - Tollgate Rd (N)	Entry	1	1	1	280	70	99999	99282	0.003	280	271	0.0	0.0	0.037	A
				2	0	0	0	0	0.000	0	0	0.0	0.0	0.000	A

Junctions 10
PICADY 10 - Priority Intersection Module
Version: 10.0.3.1598 © Copyright TRL Software Limited, 2021
For sales and distribution information, program advice and maintenance, contact TRL Software: +44 (0)1344 379777 software@trl.co.uk trlsoftware.com
The users of this computer program for the solution of an engineering problem are in no way relieved of their responsibility for the correctness of the solution

Filename: Tollgate Road.Fellowes Lane Priority Junction.j10
 Path: P:\JNY11289 - Colney Heath\Transport\Picady
 Report generation date: 27/04/2022 14:20:02

- »2022, AM
- »2022, PM
- »2027, AM
- »2027, PM
- »2027 + Dev, AM
- »2027 + Dev, PM

Summary of junction performance

	AM					PM				
	Set ID	Queue (Veh)	Delay (s)	RFC	LOS	Set ID	Queue (Veh)	Delay (s)	RFC	LOS
2022										
Stream B-C	D1	0.0	0.00	0.00	A	D2	0.0	5.69	0.00	A
Stream B-A		0.1	9.49	0.05	A		0.0	8.41	0.03	A
Stream C-AB		0.0	4.53	0.01	A		0.0	5.03	0.00	A
2027										
Stream B-C	D3	0.0	0.00	0.00	A	D4	0.0	5.71	0.00	A
Stream B-A		0.1	9.56	0.05	A		0.0	8.47	0.03	A
Stream C-AB		0.0	4.52	0.01	A		0.0	5.02	0.00	A
2027 + Dev										
Stream B-C	D5	0.0	0.00	0.00	A	D6	0.0	5.74	0.00	A
Stream B-A		0.1	9.70	0.05	A		0.0	8.58	0.03	A
Stream C-AB		0.0	4.51	0.01	A		0.0	4.98	0.00	A

There are warnings associated with one or more model runs - see the 'Data Errors and Warnings' tables for each Analysis or Demand Set.

Values shown are the highest values encountered over all time segments. Delay is the maximum value of average delay per arriving vehicle.

File summary

File Description

Title	
Location	
Site number	
Date	17/02/2022
Version	
Status	(new file)
Identifier	
Client	
Jobnumber	
Enumerator	EUR\Danesh.Aryan
Description	

Units

Distance units	Speed units	Traffic units input	Traffic units results	Flow units	Average delay units	Total delay units	Rate of delay units
m	kph	Veh	Veh	perHour	s	-Min	perMin

A - Tollgate Road (N)

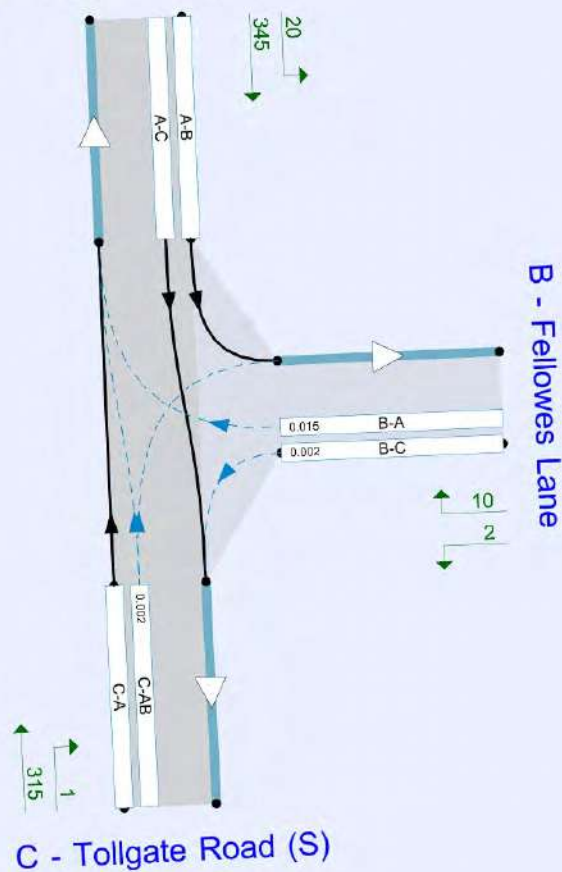

Flows show original traffic demand (Veh/hr).
Streams (downstream end) show RFC (l)

The junction diagram reflects the last run of Junctions.

Analysis Options

Vehicle length (m)	Calculate Queue Percentiles	Calculate detailed queueing delay	Show lane queues in feet / metres	Show all PICADY stream intercepts	Calculate residual capacity	RFC Threshold	Average Delay threshold (s)	Queue threshold (PCU)	Use iterations with HCM roundabouts	Max number of iterations for roundabouts
5.75						0.85	36.00	20.00		500

Demand Set Summary

ID	Scenario name	Time Period name	Traffic profile type	Start time (HH:mm)	Finish time (HH:mm)	Time segment length (min)	Run automatically
D1	2022	AM	ONE HOUR	08:00	09:30	15	✓
D2	2022	PM	ONE HOUR	17:00	18:30	15	✓
D3	2027	AM	ONE HOUR	08:00	09:30	15	✓
D4	2027	PM	ONE HOUR	17:00	18:30	15	✓
D5	2027 + Dev	AM	ONE HOUR	08:00	09:30	15	✓
D6	2027 + Dev	PM	ONE HOUR	17:00	18:30	15	✓

Analysis Set Details

ID	Include in report	Network flow scaling factor (%)	Network capacity scaling factor (%)
A1	✓	100.000	100.000

2022, AM

Data Errors and Warnings

Severity	Area	Item	Description
Warning	Minor arm flare	B - Fellowes Lane - Minor arm geometry	Is flare very short? Estimated flare length is zero but has been increased to 1 because a zero flare length is not allowed.
Warning	Minor arm visibility to right	B - Fellowes Lane - Minor arm geometry	Visibility to right expected to have two components if the arm has two lanes, or two lanes in a flared section.
Warning	Major arm width	C - Tollgate Road (S) - Major arm geometry	For two-way major roads, please interpret results with caution if the total major carriageway width is less than 6m.

Junction Network

Junctions

Junction	Name	Junction type	Arm A Direction	Arm B Direction	Arm C Direction	Use circulating lanes	Junction Delay (s)	Junction LOS
1	untitled	T-Junction	Two-way	Two-way	Two-way		0.26	A

Junction Network

Driving side	Lighting	Network delay (s)	Network LOS
Left	Normal/unknown	0.26	A

Arms

Arms

Arm	Name	Description	Arm type
A	Tollgate Road (N)		Major
B	Fellowes Lane		Minor
C	Tollgate Road (S)		Major

Major Arm Geometry

Arm	Width of carriageway (m)	Has kerbed central reserve	Has right-turn storage	Visibility for right turn (m)	Blocks?	Blocking queue (PCU)
C - Tollgate Road (S)	5.35			100.7	✓	0.00

Geometries for Arm C are measured opposite Arm B. Geometries for Arm A (if relevant) are measured opposite Arm D.

Minor Arm Geometry

Arm	Minor arm type	Width at give-way (m)	Width at 5m (m)	Width at 10m (m)	Width at 15m (m)	Width at 20m (m)	Estimate flare length	Flare length (PCU)	Visibility to left (m)	Visibility to right (m)
B - Fellowes Lane	One lane plus flare	9.10	3.80	3.80	3.40	3.30	✓	1.00	119	84

Slope / Intercept / Capacity

Priority Intersection Slopes and Intercepts

Stream	Intercept (Veh/hr)	Slope for A-B	Slope for A-C	Slope for C-A	Slope for C-B
B-A	607	0.114	0.287	0.181	0.411
B-C	751	0.118	0.299	-	-
C-B	632	0.252	0.252	-	-

The slopes and intercepts shown above include custom intercept adjustments only.

Streams may be combined, in which case capacity will be adjusted.

Values are shown for the first time segment only; they may differ for subsequent time segments.

Traffic Demand

Demand Set Details

ID	Scenario name	Time Period name	Traffic profile type	Start time (HH:mm)	Finish time (HH:mm)	Time segment length (min)	Run automatically
D1	2022	AM	ONE HOUR	08:00	09:30	15	✓

Vehicle mix varies over turn	Vehicle mix varies over entry	Vehicle mix source	PCU Factor for a HV (PCU)
✓	✓	HV Percentages	2.00

Demand overview (Traffic)

Arm	Linked arm	Profile type	Use O-D data	Average Demand (Veh/hr)	Scaling Factor (%)
A - Tollgate Road (N)		ONE HOUR	✓	296	100.000
B - Fellowes Lane		ONE HOUR	✓	18	100.000
C - Tollgate Road (S)		ONE HOUR	✓	441	100.000

Origin-Destination Data

Demand (Veh/hr)

	To		
	A - Tollgate Road (N)	B - Fellowes Lane	C - Tollgate Road (S)
From			
A - Tollgate Road (N)	0	13	283
B - Fellowes Lane	18	0	0
C - Tollgate Road (S)	439	2	0

Vehicle Mix

Heavy Vehicle Percentages

	To		
	A - Tollgate Road (N)	B - Fellowes Lane	C - Tollgate Road (S)
From			
A - Tollgate Road (N)	0	8	3
B - Fellowes Lane	6	0	0
C - Tollgate Road (S)	2	0	0

Results

Results Summary for whole modelled period

Stream	Max RFC	Max Delay (s)	Max Queue (Veh)	Max LOS	Average Demand (Veh/hr)	Total Junction Arrivals (Veh)
B-C	0.00	0.00	0.0	A	0	0
B-A	0.05	9.49	0.1	A	17	25
C-AB	0.01	4.53	0.0	A	4	5
C-A					401	602
A-B					12	18
A-C					260	390

Main Results for each time segment

08:00 - 08:15

Stream	Total Demand (Veh/hr)	Junction Arrivals (Veh)	Capacity (Veh/hr)	RFC	Throughput (Veh/hr)	Start queue (Veh)	End queue (Veh)	Delay (s)	Unsignalised level of service
B-C	0	0	679	0.000	0	0.0	0.0	0.000	A
B-A	14	3	454	0.030	13	0.0	0.0	8.170	A
C-AB	3	0.64	797	0.003	3	0.0	0.0	4.529	A
C-A	329	82			329				
A-B	10	2			10				
A-C	213	53			213				

08:15 - 08:30

Stream	Total Demand (Veh/hr)	Junction Arrivals (Veh)	Capacity (Veh/hr)	RFC	Throughput (Veh/hr)	Start queue (Veh)	End queue (Veh)	Delay (s)	Unsignalised level of service
B-C	0	0	665	0.000	0	0.0	0.0	0.000	A
B-A	16	4	431	0.038	16	0.0	0.0	8.679	A
C-AB	3	0.86	832	0.004	3	0.0	0.0	4.343	A
C-A	393	98			393				
A-B	12	3			12				
A-C	254	64			254				

08:30 - 08:45

Stream	Total Demand (Veh/hr)	Junction Arrivals (Veh)	Capacity (Veh/hr)	RFC	Throughput (Veh/hr)	Start queue (Veh)	End queue (Veh)	Delay (s)	Unsignalised level of service
B-C	0	0	645	0.000	0	0.0	0.0	0.000	A
B-A	20	5	399	0.050	20	0.0	0.1	9.490	A
C-AB	5	1	881	0.006	5	0.0	0.0	4.106	A
C-A	481	120			481				
A-B	14	4			14				
A-C	312	78			312				

08:45 - 09:00

Stream	Total Demand (Veh/hr)	Junction Arrivals (Veh)	Capacity (Veh/hr)	RFC	Throughput (Veh/hr)	Start queue (Veh)	End queue (Veh)	Delay (s)	Unsignalised level of service
B-C	0	0	645	0.000	0	0.0	0.0	0.000	A
B-A	20	5	399	0.050	20	0.1	0.1	9.492	A
C-AB	5	1	881	0.006	5	0.0	0.0	4.110	A
C-A	481	120			481				
A-B	14	4			14				
A-C	312	78			312				

09:00 - 09:15

Stream	Total Demand (Veh/hr)	Junction Arrivals (Veh)	Capacity (Veh/hr)	RFC	Throughput (Veh/hr)	Start queue (Veh)	End queue (Veh)	Delay (s)	Unsignalised level of service
B-C	0	0	665	0.000	0	0.0	0.0	0.000	A
B-A	16	4	431	0.038	16	0.1	0.0	8.683	A
C-AB	3	0.86	832	0.004	3	0.0	0.0	4.349	A
C-A	393	98			393				
A-B	12	3			12				
A-C	254	64			254				

09:15 - 09:30

Stream	Total Demand (Veh/hr)	Junction Arrivals (Veh)	Capacity (Veh/hr)	RFC	Throughput (Veh/hr)	Start queue (Veh)	End queue (Veh)	Delay (s)	Unsignalised level of service
B-C	0	0	679	0.000	0	0.0	0.0	0.000	A
B-A	14	3	454	0.030	14	0.0	0.0	8.175	A
C-AB	3	0.64	797	0.003	3	0.0	0.0	4.532	A
C-A	329	82			329				
A-B	10	2			10				
A-C	213	53			213				

2022, PM

Data Errors and Warnings

Severity	Area	Item	Description
Warning	Minor arm flare	B - Fellowes Lane - Minor arm geometry	Is flare very short? Estimated flare length is zero but has been increased to 1 because a zero flare length is not allowed.
Warning	Minor arm visibility to right	B - Fellowes Lane - Minor arm geometry	Visibility to right expected to have two components if the arm has two lanes, or two lanes in a flared section.
Warning	Major arm width	C - Tollgate Road (S) - Major arm geometry	For two-way major roads, please interpret results with caution if the total major carriageway width is less than 6m.

Junction Network

Junctions

Junction	Name	Junction type	Arm A Direction	Arm B Direction	Arm C Direction	Use circulating lanes	Junction Delay (s)	Junction LOS
1	untitled	T-Junction	Two-way	Two-way	Two-way		0.16	A

Junction Network

Driving side	Lighting	Network delay (s)	Network LOS
Left	Normal/unknown	0.16	A

Traffic Demand

Demand Set Details

ID	Scenario name	Time Period name	Traffic profile type	Start time (HH:mm)	Finish time (HH:mm)	Time segment length (min)	Run automatically
D2	2022	PM	ONE HOUR	17:00	18:30	15	✓

Vehicle mix varies over turn	Vehicle mix varies over entry	Vehicle mix source	PCU Factor for a HV (PCU)
✓	✓	HV Percentages	2.00

Demand overview (Traffic)

Arm	Linked arm	Profile type	Use O-D data	Average Demand (Veh/hr)	Scaling Factor (%)
A - Tollgate Road (N)		ONE HOUR	✓	351	100.000
B - Fellowes Lane		ONE HOUR	✓	12	100.000
C - Tollgate Road (S)		ONE HOUR	✓	297	100.000

Origin-Destination Data

Demand (Veh/hr)

		To		
		A - Tollgate Road (N)	B - Fellowes Lane	C - Tollgate Road (S)
From	A - Tollgate Road (N)	0	20	331
	B - Fellowes Lane	10	0	2
	C - Tollgate Road (S)	296	1	0

Vehicle Mix

Heavy Vehicle Percentages

From	To		
	A - Tollgate Road (N)	B - Fellowes Lane	C - Tollgate Road (S)
A - Tollgate Road (N)	0	0	1
B - Fellowes Lane	0	0	0
C - Tollgate Road (S)	1	0	0

Results

Results Summary for whole modelled period

Stream	Max RFC	Max Delay (s)	Max Queue (Veh)	Max LOS	Average Demand (Veh/hr)	Total Junction Arrivals (Veh)
B-C	0.00	5.69	0.0	A	2	3
B-A	0.03	8.41	0.0	A	9	14
C-AB	0.00	5.03	0.0	A	1	2
C-A					271	407
A-B					18	28
A-C					304	456

Main Results for each time segment

17:00 - 17:15

Stream	Total Demand (Veh/hr)	Junction Arrivals (Veh)	Capacity (Veh/hr)	RFC	Throughput (Veh/hr)	Start queue (Veh)	End queue (Veh)	Delay (s)	Unsignalised level of service
B-C	2	0.38	671	0.002	1	0.0	0.0	5.372	A
B-A	8	2	492	0.015	7	0.0	0.0	7.430	A
C-AB	1	0.27	717	0.002	1	0.0	0.0	5.026	A
C-A	223	56			223				
A-B	15	4			15				
A-C	249	62			249				

17:15 - 17:30

Stream	Total Demand (Veh/hr)	Junction Arrivals (Veh)	Capacity (Veh/hr)	RFC	Throughput (Veh/hr)	Start queue (Veh)	End queue (Veh)	Delay (s)	Unsignalised level of service
B-C	2	0.45	656	0.003	2	0.0	0.0	5.503	A
B-A	9	2	470	0.019	9	0.0	0.0	7.814	A
C-AB	1	0.35	736	0.002	1	0.0	0.0	4.901	A
C-A	266	66			266				
A-B	18	4			18				
A-C	298	74			298				

17:30 - 17:45

Stream	Total Demand (Veh/hr)	Junction Arrivals (Veh)	Capacity (Veh/hr)	RFC	Throughput (Veh/hr)	Start queue (Veh)	End queue (Veh)	Delay (s)	Unsignalised level of service
B-C	2	0.55	634	0.003	2	0.0	0.0	5.694	A
B-A	11	3	439	0.025	11	0.0	0.0	8.415	A
C-AB	2	0.48	762	0.003	2	0.0	0.0	4.733	A
C-A	325	81			325				
A-B	22	6			22				
A-C	364	91			364				

17:45 - 18:00

Stream	Total Demand (Veh/hr)	Junction Arrivals (Veh)	Capacity (Veh/hr)	RFC	Throughput (Veh/hr)	Start queue (Veh)	End queue (Veh)	Delay (s)	Unsignalised level of service
B-C	2	0.55	634	0.003	2	0.0	0.0	5.694	A
B-A	11	3	439	0.025	11	0.0	0.0	8.415	A
C-AB	2	0.48	762	0.003	2	0.0	0.0	4.736	A
C-A	325	81			325				
A-B	22	6			22				
A-C	364	91			364				

18:00 - 18:15

Stream	Total Demand (Veh/hr)	Junction Arrivals (Veh)	Capacity (Veh/hr)	RFC	Throughput (Veh/hr)	Start queue (Veh)	End queue (Veh)	Delay (s)	Unsignalised level of service
B-C	2	0.45	656	0.003	2	0.0	0.0	5.503	A
B-A	9	2	470	0.019	9	0.0	0.0	7.815	A
C-AB	1	0.35	736	0.002	1	0.0	0.0	4.906	A
C-A	266	66			266				
A-B	18	4			18				
A-C	298	74			298				

18:15 - 18:30

Stream	Total Demand (Veh/hr)	Junction Arrivals (Veh)	Capacity (Veh/hr)	RFC	Throughput (Veh/hr)	Start queue (Veh)	End queue (Veh)	Delay (s)	Unsignalised level of service
B-C	2	0.38	671	0.002	2	0.0	0.0	5.373	A
B-A	8	2	492	0.015	8	0.0	0.0	7.430	A
C-AB	1	0.27	717	0.002	1	0.0	0.0	5.027	A
C-A	223	56			223				
A-B	15	4			15				
A-C	249	62			249				

2027, AM

Data Errors and Warnings

Severity	Area	Item	Description
Warning	Minor arm flare	B - Fellowes Lane - Minor arm geometry	Is flare very short? Estimated flare length is zero but has been increased to 1 because a zero flare length is not allowed.
Warning	Minor arm visibility to right	B - Fellowes Lane - Minor arm geometry	Visibility to right expected to have two components if the arm has two lanes, or two lanes in a flared section.
Warning	Major arm width	C - Tollgate Road (S) - Major arm geometry	For two-way major roads, please interpret results with caution if the total major carriageway width is less than 6m.

Junction Network

Junctions

Junction	Name	Junction type	Arm A Direction	Arm B Direction	Arm C Direction	Use circulating lanes	Junction Delay (s)	Junction LOS
1	untitled	T-Junction	Two-way	Two-way	Two-way		0.26	A

Junction Network

Driving side	Lighting	Network delay (s)	Network LOS
Left	Normal/unknown	0.26	A

Traffic Demand

Demand Set Details

ID	Scenario name	Time Period name	Traffic profile type	Start time (HH:mm)	Finish time (HH:mm)	Time segment length (min)	Run automatically
D3	2027	AM	ONE HOUR	08:00	09:30	15	✓

Vehicle mix varies over turn	Vehicle mix varies over entry	Vehicle mix source	PCU Factor for a HV (PCU)
✓	✓	HV Percentages	2.00

Demand overview (Traffic)

Arm	Linked arm	Profile type	Use O-D data	Average Demand (Veh/hr)	Scaling Factor (%)
A - Tollgate Road (N)		ONE HOUR	✓	300	100.000
B - Fellowes Lane		ONE HOUR	✓	18	100.000
C - Tollgate Road (S)		ONE HOUR	✓	448	100.000

Origin-Destination Data

Demand (Veh/hr)

		To		
		A - Tollgate Road (N)	B - Fellowes Lane	C - Tollgate Road (S)
From	A - Tollgate Road (N)	0	13	287
	B - Fellowes Lane	18	0	0
	C - Tollgate Road (S)	446	2	0

Vehicle Mix

Heavy Vehicle Percentages

From	To		
	A - Tollgate Road (N)	B - Fellowes Lane	C - Tollgate Road (S)
A - Tollgate Road (N)	0	8	3
B - Fellowes Lane	6	0	0
C - Tollgate Road (S)	2	0	0

Results

Results Summary for whole modelled period

Stream	Max RFC	Max Delay (s)	Max Queue (Veh)	Max LOS	Average Demand (Veh/hr)	Total Junction Arrivals (Veh)
B-C	0.00	0.00	0.0	A	0	0
B-A	0.05	9.56	0.1	A	17	25
C-AB	0.01	4.52	0.0	A	4	6
C-A					407	611
A-B					12	18
A-C					263	395

Main Results for each time segment

08:00 - 08:15

Stream	Total Demand (Veh/hr)	Junction Arrivals (Veh)	Capacity (Veh/hr)	RFC	Throughput (Veh/hr)	Start queue (Veh)	End queue (Veh)	Delay (s)	Unsignalised level of service
B-C	0	0	678	0.000	0	0.0	0.0	0.000	A
B-A	14	3	452	0.030	13	0.0	0.0	8.203	A
C-AB	3	0.65	800	0.003	3	0.0	0.0	4.513	A
C-A	335	84			335				
A-B	10	2			10				
A-C	216	54			216				

08:15 - 08:30

Stream	Total Demand (Veh/hr)	Junction Arrivals (Veh)	Capacity (Veh/hr)	RFC	Throughput (Veh/hr)	Start queue (Veh)	End queue (Veh)	Delay (s)	Unsignalised level of service
B-C	0	0	664	0.000	0	0.0	0.0	0.000	A
B-A	16	4	429	0.038	16	0.0	0.0	8.724	A
C-AB	3	0.87	835	0.004	3	0.0	0.0	4.324	A
C-A	399	100			399				
A-B	12	3			12				
A-C	258	65			258				

08:30 - 08:45

Stream	Total Demand (Veh/hr)	Junction Arrivals (Veh)	Capacity (Veh/hr)	RFC	Throughput (Veh/hr)	Start queue (Veh)	End queue (Veh)	Delay (s)	Unsignalised level of service
B-C	0	0	644	0.000	0	0.0	0.0	0.000	A
B-A	20	5	396	0.050	20	0.0	0.1	9.555	A
C-AB	5	1	885	0.006	5	0.0	0.0	4.086	A
C-A	488	122			488				
A-B	14	4			14				
A-C	316	79			316				

08:45 - 09:00

Stream	Total Demand (Veh/hr)	Junction Arrivals (Veh)	Capacity (Veh/hr)	RFC	Throughput (Veh/hr)	Start queue (Veh)	End queue (Veh)	Delay (s)	Unsignalised level of service
B-C	0	0	644	0.000	0	0.0	0.0	0.000	A
B-A	20	5	396	0.050	20	0.1	0.1	9.557	A
C-AB	5	1	885	0.006	5	0.0	0.0	4.088	A
C-A	488	122			488				
A-B	14	4			14				
A-C	316	79			316				

09:00 - 09:15

Stream	Total Demand (Veh/hr)	Junction Arrivals (Veh)	Capacity (Veh/hr)	RFC	Throughput (Veh/hr)	Start queue (Veh)	End queue (Veh)	Delay (s)	Unsignalised level of service
B-C	0	0	664	0.000	0	0.0	0.0	0.000	A
B-A	16	4	429	0.038	16	0.1	0.0	8.726	A
C-AB	3	0.87	835	0.004	3	0.0	0.0	4.332	A
C-A	399	100			399				
A-B	12	3			12				
A-C	258	65			258				

09:15 - 09:30

Stream	Total Demand (Veh/hr)	Junction Arrivals (Veh)	Capacity (Veh/hr)	RFC	Throughput (Veh/hr)	Start queue (Veh)	End queue (Veh)	Delay (s)	Unsignalised level of service
B-C	0	0	678	0.000	0	0.0	0.0	0.000	A
B-A	14	3	452	0.030	14	0.0	0.0	8.208	A
C-AB	3	0.65	800	0.003	3	0.0	0.0	4.516	A
C-A	335	84			335				
A-B	10	2			10				
A-C	216	54			216				

2027, PM

Data Errors and Warnings

Severity	Area	Item	Description
Warning	Minor arm flare	B - Fellowes Lane - Minor arm geometry	Is flare very short? Estimated flare length is zero but has been increased to 1 because a zero flare length is not allowed.
Warning	Minor arm visibility to right	B - Fellowes Lane - Minor arm geometry	Visibility to right expected to have two components if the arm has two lanes, or two lanes in a flared section.
Warning	Major arm width	C - Tollgate Road (S) - Major arm geometry	For two-way major roads, please interpret results with caution if the total major carriageway width is less than 6m.

Junction Network

Junctions

Junction	Name	Junction type	Arm A Direction	Arm B Direction	Arm C Direction	Use circulating lanes	Junction Delay (s)	Junction LOS
1	untitled	T-Junction	Two-way	Two-way	Two-way		0.15	A

Junction Network

Driving side	Lighting	Network delay (s)	Network LOS
Left	Normal/unknown	0.15	A

Traffic Demand

Demand Set Details

ID	Scenario name	Time Period name	Traffic profile type	Start time (HH:mm)	Finish time (HH:mm)	Time segment length (min)	Run automatically
D4	2027	PM	ONE HOUR	17:00	18:30	15	✓

Vehicle mix varies over turn	Vehicle mix varies over entry	Vehicle mix source	PCU Factor for a HV (PCU)
✓	✓	HV Percentages	2.00

Demand overview (Traffic)

Arm	Linked arm	Profile type	Use O-D data	Average Demand (Veh/hr)	Scaling Factor (%)
A - Tollgate Road (N)		ONE HOUR	✓	356	100.000
B - Fellowes Lane		ONE HOUR	✓	12	100.000
C - Tollgate Road (S)		ONE HOUR	✓	302	100.000

Origin-Destination Data

Demand (Veh/hr)

		To		
		A - Tollgate Road (N)	B - Fellowes Lane	C - Tollgate Road (S)
From	A - Tollgate Road (N)	0	20	336
	B - Fellowes Lane	10	0	2
	C - Tollgate Road (S)	301	1	0

Vehicle Mix

Heavy Vehicle Percentages

From	To		
	A - Tollgate Road (N)	B - Fellowes Lane	C - Tollgate Road (S)
A - Tollgate Road (N)	0	0	1
B - Fellowes Lane	0	0	0
C - Tollgate Road (S)	1	0	0

Results

Results Summary for whole modelled period

Stream	Max RFC	Max Delay (s)	Max Queue (Veh)	Max LOS	Average Demand (Veh/hr)	Total Junction Arrivals (Veh)
B-C	0.00	5.71	0.0	A	2	3
B-A	0.03	8.47	0.0	A	9	14
C-AB	0.00	5.02	0.0	A	1	2
C-A					276	413
A-B					18	28
A-C					308	462

Main Results for each time segment

17:00 - 17:15

Stream	Total Demand (Veh/hr)	Junction Arrivals (Veh)	Capacity (Veh/hr)	RFC	Throughput (Veh/hr)	Start queue (Veh)	End queue (Veh)	Delay (s)	Unsignalised level of service
B-C	2	0.38	670	0.002	1	0.0	0.0	5.382	A
B-A	8	2	490	0.015	7	0.0	0.0	7.457	A
C-AB	1	0.27	719	0.002	1	0.0	0.0	5.014	A
C-A	226	57			226				
A-B	15	4			15				
A-C	253	63			253				

17:15 - 17:30

Stream	Total Demand (Veh/hr)	Junction Arrivals (Veh)	Capacity (Veh/hr)	RFC	Throughput (Veh/hr)	Start queue (Veh)	End queue (Veh)	Delay (s)	Unsignalised level of service
B-C	2	0.45	655	0.003	2	0.0	0.0	5.514	A
B-A	9	2	468	0.019	9	0.0	0.0	7.850	A
C-AB	1	0.36	738	0.002	1	0.0	0.0	4.886	A
C-A	270	68			270				
A-B	18	4			18				
A-C	302	76			302				

17:30 - 17:45

Stream	Total Demand (Veh/hr)	Junction Arrivals (Veh)	Capacity (Veh/hr)	RFC	Throughput (Veh/hr)	Start queue (Veh)	End queue (Veh)	Delay (s)	Unsignalised level of service
B-C	2	0.55	633	0.003	2	0.0	0.0	5.709	A
B-A	11	3	436	0.025	11	0.0	0.0	8.466	A
C-AB	2	0.49	765	0.003	2	0.0	0.0	4.716	A
C-A	331	83			331				
A-B	22	6			22				
A-C	370	92			370				

17:45 - 18:00

Stream	Total Demand (Veh/hr)	Junction Arrivals (Veh)	Capacity (Veh/hr)	RFC	Throughput (Veh/hr)	Start queue (Veh)	End queue (Veh)	Delay (s)	Unsignalised level of service
B-C	2	0.55	633	0.003	2	0.0	0.0	5.709	A
B-A	11	3	436	0.025	11	0.0	0.0	8.466	A
C-AB	2	0.49	765	0.003	2	0.0	0.0	4.717	A
C-A	331	83			331				
A-B	22	6			22				
A-C	370	92			370				

18:00 - 18:15

Stream	Total Demand (Veh/hr)	Junction Arrivals (Veh)	Capacity (Veh/hr)	RFC	Throughput (Veh/hr)	Start queue (Veh)	End queue (Veh)	Delay (s)	Unsignalised level of service
B-C	2	0.45	655	0.003	2	0.0	0.0	5.514	A
B-A	9	2	468	0.019	9	0.0	0.0	7.853	A
C-AB	1	0.36	738	0.002	1	0.0	0.0	4.891	A
C-A	270	68			270				
A-B	18	4			18				
A-C	302	76			302				

18:15 - 18:30

Stream	Total Demand (Veh/hr)	Junction Arrivals (Veh)	Capacity (Veh/hr)	RFC	Throughput (Veh/hr)	Start queue (Veh)	End queue (Veh)	Delay (s)	Unsignalised level of service
B-C	2	0.38	670	0.002	2	0.0	0.0	5.382	A
B-A	8	2	490	0.015	8	0.0	0.0	7.460	A
C-AB	1	0.28	719	0.002	1	0.0	0.0	5.017	A
C-A	226	57			226				
A-B	15	4			15				
A-C	253	63			253				

2027 + Dev, AM

Data Errors and Warnings

Severity	Area	Item	Description
Warning	Minor arm flare	B - Fellowes Lane - Minor arm geometry	Is flare very short? Estimated flare length is zero but has been increased to 1 because a zero flare length is not allowed.
Warning	Minor arm visibility to right	B - Fellowes Lane - Minor arm geometry	Visibility to right expected to have two components if the arm has two lanes, or two lanes in a flared section.
Warning	Major arm width	C - Tollgate Road (S) - Major arm geometry	For two-way major roads, please interpret results with caution if the total major carriageway width is less than 6m.

Junction Network

Junctions

Junction	Name	Junction type	Arm A Direction	Arm B Direction	Arm C Direction	Use circulating lanes	Junction Delay (s)	Junction LOS
1	untitled	T-Junction	Two-way	Two-way	Two-way		0.25	A

Junction Network

Driving side	Lighting	Network delay (s)	Network LOS
Left	Normal/unknown	0.25	A

Traffic Demand

Demand Set Details

ID	Scenario name	Time Period name	Traffic profile type	Start time (HH:mm)	Finish time (HH:mm)	Time segment length (min)	Run automatically
D5	2027 + Dev	AM	ONE HOUR	08:00	09:30	15	✓

Vehicle mix varies over turn	Vehicle mix varies over entry	Vehicle mix source	PCU Factor for a HV (PCU)
✓	✓	HV Percentages	2.00

Demand overview (Traffic)

Arm	Linked arm	Profile type	Use O-D data	Average Demand (Veh/hr)	Scaling Factor (%)
A - Tollgate Road (N)		ONE HOUR	✓	315	100.000
B - Fellowes Lane		ONE HOUR	✓	18	100.000
C - Tollgate Road (S)		ONE HOUR	✓	454	100.000

Origin-Destination Data

Demand (Veh/hr)

		To		
		A - Tollgate Road (N)	B - Fellowes Lane	C - Tollgate Road (S)
From	A - Tollgate Road (N)	0	13	302
	B - Fellowes Lane	18	0	0
	C - Tollgate Road (S)	452	2	0

Vehicle Mix

Heavy Vehicle Percentages

From	To		
	A - Tollgate Road (N)	B - Fellowes Lane	C - Tollgate Road (S)
A - Tollgate Road (N)	0	8	3
B - Fellowes Lane	6	0	0
C - Tollgate Road (S)	2	0	0

Results

Results Summary for whole modelled period

Stream	Max RFC	Max Delay (s)	Max Queue (Veh)	Max LOS	Average Demand (Veh/hr)	Total Junction Arrivals (Veh)
B-C	0.00	0.00	0.0	A	0	0
B-A	0.05	9.70	0.1	A	17	25
C-AB	0.01	4.51	0.0	A	4	6
C-A					413	619
A-B					12	18
A-C					277	416

Main Results for each time segment

08:00 - 08:15

Stream	Total Demand (Veh/hr)	Junction Arrivals (Veh)	Capacity (Veh/hr)	RFC	Throughput (Veh/hr)	Start queue (Veh)	End queue (Veh)	Delay (s)	Unsignalised level of service
B-C	0	0	675	0.000	0	0.0	0.0	0.000	A
B-A	14	3	448	0.030	13	0.0	0.0	8.277	A
C-AB	3	0.65	801	0.003	3	0.0	0.0	4.509	A
C-A	339	85			339				
A-B	10	2			10				
A-C	227	57			227				

08:15 - 08:30

Stream	Total Demand (Veh/hr)	Junction Arrivals (Veh)	Capacity (Veh/hr)	RFC	Throughput (Veh/hr)	Start queue (Veh)	End queue (Veh)	Delay (s)	Unsignalised level of service
B-C	0	0	660	0.000	0	0.0	0.0	0.000	A
B-A	16	4	424	0.038	16	0.0	0.0	8.824	A
C-AB	4	0.88	836	0.004	4	0.0	0.0	4.319	A
C-A	405	101			405				
A-B	12	3			12				
A-C	271	68			271				

08:30 - 08:45

Stream	Total Demand (Veh/hr)	Junction Arrivals (Veh)	Capacity (Veh/hr)	RFC	Throughput (Veh/hr)	Start queue (Veh)	End queue (Veh)	Delay (s)	Unsignalised level of service
B-C	0	0	639	0.000	0	0.0	0.0	0.000	A
B-A	20	5	391	0.051	20	0.0	0.1	9.703	A
C-AB	5	1	887	0.006	5	0.0	0.0	4.079	A
C-A	495	124			495				
A-B	14	4			14				
A-C	333	83			333				

08:45 - 09:00

Stream	Total Demand (Veh/hr)	Junction Arrivals (Veh)	Capacity (Veh/hr)	RFC	Throughput (Veh/hr)	Start queue (Veh)	End queue (Veh)	Delay (s)	Unsignalised level of service
B-C	0	0	639	0.000	0	0.0	0.0	0.000	A
B-A	20	5	391	0.051	20	0.1	0.1	9.705	A
C-AB	5	1	887	0.006	5	0.0	0.0	4.083	A
C-A	495	124			495				
A-B	14	4			14				
A-C	333	83			333				

09:00 - 09:15

Stream	Total Demand (Veh/hr)	Junction Arrivals (Veh)	Capacity (Veh/hr)	RFC	Throughput (Veh/hr)	Start queue (Veh)	End queue (Veh)	Delay (s)	Unsignalised level of service
B-C	0	0	660	0.000	0	0.0	0.0	0.000	A
B-A	16	4	424	0.038	16	0.1	0.0	8.828	A
C-AB	4	0.88	836	0.004	4	0.0	0.0	4.326	A
C-A	405	101			405				
A-B	12	3			12				
A-C	271	68			271				

09:15 - 09:30

Stream	Total Demand (Veh/hr)	Junction Arrivals (Veh)	Capacity (Veh/hr)	RFC	Throughput (Veh/hr)	Start queue (Veh)	End queue (Veh)	Delay (s)	Unsignalised level of service
B-C	0	0	675	0.000	0	0.0	0.0	0.000	A
B-A	14	3	448	0.030	14	0.0	0.0	8.282	A
C-AB	3	0.66	801	0.003	3	0.0	0.0	4.512	A
C-A	339	85			339				
A-B	10	2			10				
A-C	227	57			227				

2027 + Dev, PM

Data Errors and Warnings

Severity	Area	Item	Description
Warning	Minor arm flare	B - Fellowes Lane - Minor arm geometry	Is flare very short? Estimated flare length is zero but has been increased to 1 because a zero flare length is not allowed.
Warning	Minor arm visibility to right	B - Fellowes Lane - Minor arm geometry	Visibility to right expected to have two components if the arm has two lanes, or two lanes in a flared section.
Warning	Major arm width	C - Tollgate Road (S) - Major arm geometry	For two-way major roads, please interpret results with caution if the total major carriageway width is less than 6m.

Junction Network

Junctions

Junction	Name	Junction type	Arm A Direction	Arm B Direction	Arm C Direction	Use circulating lanes	Junction Delay (s)	Junction LOS
1	untitled	T-Junction	Two-way	Two-way	Two-way		0.15	A

Junction Network

Driving side	Lighting	Network delay (s)	Network LOS
Left	Normal/unknown	0.15	A

Traffic Demand

Demand Set Details

ID	Scenario name	Time Period name	Traffic profile type	Start time (HH:mm)	Finish time (HH:mm)	Time segment length (min)	Run automatically
D6	2027 + Dev	PM	ONE HOUR	17:00	18:30	15	✓

Vehicle mix varies over turn	Vehicle mix varies over entry	Vehicle mix source	PCU Factor for a HV (PCU)
✓	✓	HV Percentages	2.00

Demand overview (Traffic)

Arm	Linked arm	Profile type	Use O-D data	Average Demand (Veh/hr)	Scaling Factor (%)
A - Tollgate Road (N)		ONE HOUR	✓	365	100.000
B - Fellowes Lane		ONE HOUR	✓	12	100.000
C - Tollgate Road (S)		ONE HOUR	✓	316	100.000

Origin-Destination Data

Demand (Veh/hr)

		To		
		A - Tollgate Road (N)	B - Fellowes Lane	C - Tollgate Road (S)
From	A - Tollgate Road (N)	0	20	345
	B - Fellowes Lane	10	0	2
	C - Tollgate Road (S)	315	1	0

Vehicle Mix

Heavy Vehicle Percentages

From	To		
	A - Tollgate Road (N)	B - Fellowes Lane	C - Tollgate Road (S)
A - Tollgate Road (N)	0	0	1
B - Fellowes Lane	0	0	0
C - Tollgate Road (S)	1	0	0

Results

Results Summary for whole modelled period

Stream	Max RFC	Max Delay (s)	Max Queue (Veh)	Max LOS	Average Demand (Veh/hr)	Total Junction Arrivals (Veh)
B-C	0.00	5.74	0.0	A	2	3
B-A	0.03	8.58	0.0	A	9	14
C-AB	0.00	4.98	0.0	A	2	2
C-A					288	433
A-B					18	28
A-C					317	475

Main Results for each time segment

17:00 - 17:15

Stream	Total Demand (Veh/hr)	Junction Arrivals (Veh)	Capacity (Veh/hr)	RFC	Throughput (Veh/hr)	Start queue (Veh)	End queue (Veh)	Delay (s)	Unsignalised level of service
B-C	2	0.38	668	0.002	1	0.0	0.0	5.398	A
B-A	8	2	486	0.015	7	0.0	0.0	7.518	A
C-AB	1	0.28	725	0.002	1	0.0	0.0	4.974	A
C-A	237	59			237				
A-B	15	4			15				
A-C	260	65			260				

17:15 - 17:30

Stream	Total Demand (Veh/hr)	Junction Arrivals (Veh)	Capacity (Veh/hr)	RFC	Throughput (Veh/hr)	Start queue (Veh)	End queue (Veh)	Delay (s)	Unsignalised level of service
B-C	2	0.45	652	0.003	2	0.0	0.0	5.535	A
B-A	9	2	463	0.019	9	0.0	0.0	7.931	A
C-AB	1	0.36	745	0.002	1	0.0	0.0	4.841	A
C-A	283	71			283				
A-B	18	4			18				
A-C	310	78			310				

17:30 - 17:45

Stream	Total Demand (Veh/hr)	Junction Arrivals (Veh)	Capacity (Veh/hr)	RFC	Throughput (Veh/hr)	Start queue (Veh)	End queue (Veh)	Delay (s)	Unsignalised level of service
B-C	2	0.55	630	0.004	2	0.0	0.0	5.737	A
B-A	11	3	430	0.026	11	0.0	0.0	8.581	A
C-AB	2	0.50	774	0.003	2	0.0	0.0	4.663	A
C-A	346	86			346				
A-B	22	6			22				
A-C	380	95			380				

17:45 - 18:00

Stream	Total Demand (Veh/hr)	Junction Arrivals (Veh)	Capacity (Veh/hr)	RFC	Throughput (Veh/hr)	Start queue (Veh)	End queue (Veh)	Delay (s)	Unsignalised level of service
B-C	2	0.55	630	0.004	2	0.0	0.0	5.737	A
B-A	11	3	430	0.026	11	0.0	0.0	8.581	A
C-AB	2	0.50	774	0.003	2	0.0	0.0	4.664	A
C-A	346	86			346				
A-B	22	6			22				
A-C	380	95			380				

18:00 - 18:15

Stream	Total Demand (Veh/hr)	Junction Arrivals (Veh)	Capacity (Veh/hr)	RFC	Throughput (Veh/hr)	Start queue (Veh)	End queue (Veh)	Delay (s)	Unsignalised level of service
B-C	2	0.45	652	0.003	2	0.0	0.0	5.535	A
B-A	9	2	463	0.019	9	0.0	0.0	7.933	A
C-AB	1	0.36	745	0.002	1	0.0	0.0	4.846	A
C-A	283	71			283				
A-B	18	4			18				
A-C	310	78			310				

18:15 - 18:30

Stream	Total Demand (Veh/hr)	Junction Arrivals (Veh)	Capacity (Veh/hr)	RFC	Throughput (Veh/hr)	Start queue (Veh)	End queue (Veh)	Delay (s)	Unsignalised level of service
B-C	2	0.38	668	0.002	2	0.0	0.0	5.401	A
B-A	8	2	486	0.015	8	0.0	0.0	7.521	A
C-AB	1	0.28	725	0.002	1	0.0	0.0	4.978	A
C-A	237	59			237				
A-B	15	4			15				
A-C	260	65			260				

Junctions 10
PICADY 10 - Priority Intersection Module
Version: 10.0.3.1598 © Copyright TRL Software Limited, 2021
For sales and distribution information, program advice and maintenance, contact TRL Software: +44 (0)1344 379777 software@trl.co.uk trlsoftware.com
The users of this computer program for the solution of an engineering problem are in no way relieved of their responsibility for the correctness of the solution

Filename: Tollgate Road.Site Access.Fellowes Lane Junction.j10
Path: P:\JNY11289 - Colney Heath\Transport\Picady
Report generation date: 17/05/2022 15:19:44

»2027 + Dev, AM
 »2027 + Dev, PM

Summary of junction performance

	AM					PM				
	Set ID	Queue (Veh)	Delay (s)	RFC	LOS	Set ID	Queue (Veh)	Delay (s)	RFC	LOS
2027 + Dev										
Stream B-CD	D1	0.1	7.15	0.06	A	D2	0.0	6.40	0.03	A
Stream B-AD		0.0	9.67	0.04	A		0.0	8.79	0.02	A
Stream A-BCD		0.0	4.64	0.01	A		0.0	5.13	0.00	A
Stream D-ABC		0.1	14.05	0.07	B		0.0	11.56	0.04	B
Stream C-ABD		0.1	5.39	0.04	A		0.2	5.17	0.08	A

There are warnings associated with one or more model runs - see the 'Data Errors and Warnings' tables for each Analysis or Demand Set.

Values shown are the highest values encountered over all time segments. Delay is the maximum value of average delay per arriving vehicle.

File summary

File Description

Title	
Location	
Site number	
Date	17/05/2022
Version	
Status	(new file)
Identifier	
Client	
Jobnumber	
Enumerator	EUR\George.Magnisalis
Description	

Units

Distance units	Speed units	Traffic units input	Traffic units results	Flow units	Average delay units	Total delay units	Rate of delay units
m	kph	Veh	Veh	perHour	s	-Min	perMin

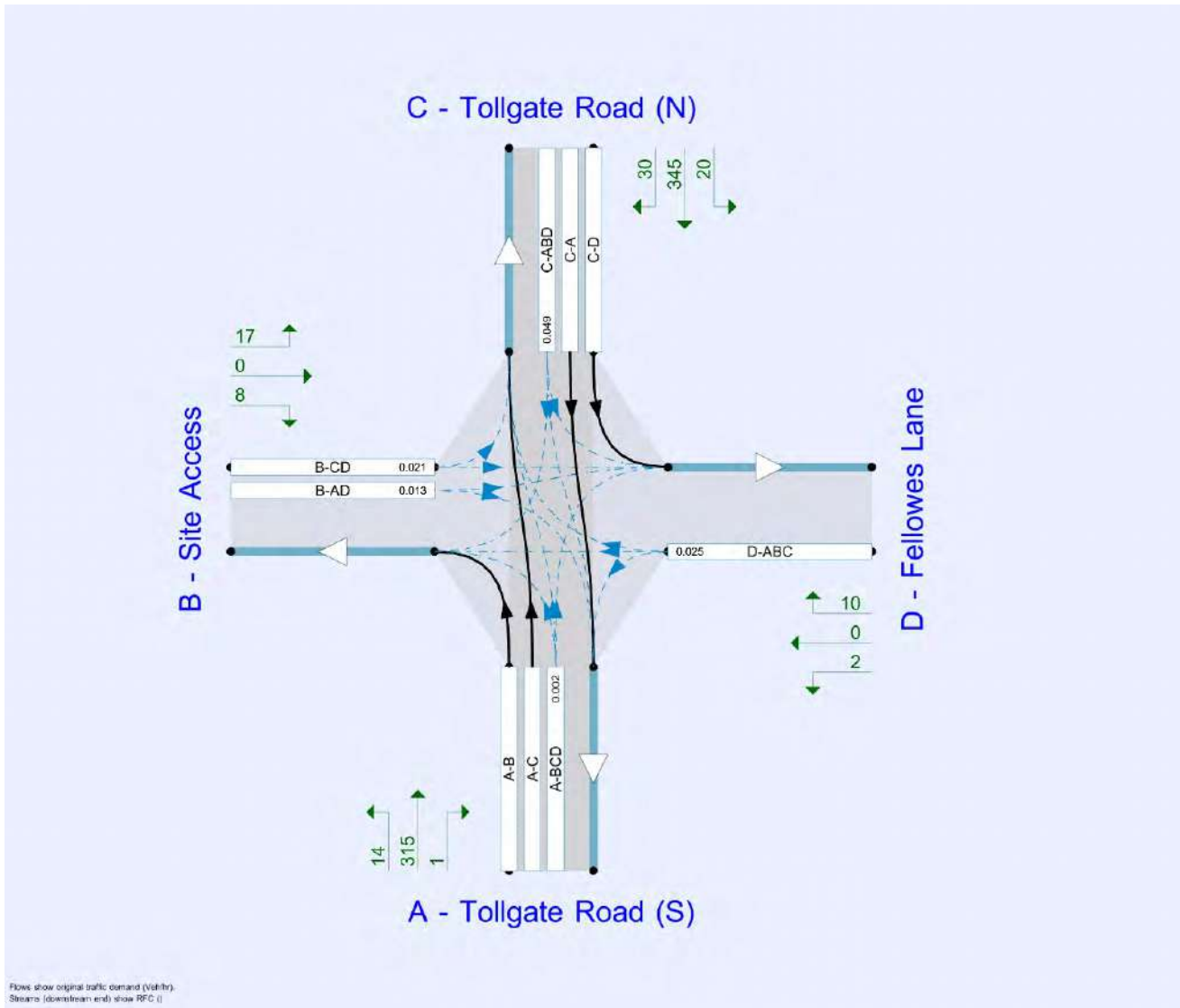

The junction diagram reflects the last run of Junctions.

Analysis Options

Calculate Queue Percentiles	Calculate residual capacity	RFC Threshold	Average Delay threshold (s)	Queue threshold (PCU)
		0.85	36.00	20.00

Demand Set Summary

ID	Scenario name	Time Period name	Traffic profile type	Start time (HH:mm)	Finish time (HH:mm)	Time segment length (min)
D1	2027 + Dev	AM	ONE HOUR	08:00	09:30	15
D2	2027 + Dev	PM	ONE HOUR	17:00	18:30	15

Analysis Set Details

ID	Network flow scaling factor (%)
A1	100.000

2027 + Dev, AM

Data Errors and Warnings

Severity	Area	Item	Description
Warning	Minor arm visibility to right	B - Site Access - Minor arm geometry	Visibility to right expected to have two components if the arm has two lanes, or two lanes in a flared section.

Junction Network

Junctions

Junction	Name	Junction type	Arm A Direction	Arm B Direction	Arm C Direction	Arm D Direction	Use circulating lanes	Junction Delay (s)	Junction LOS
1	Tollgate Rd_Site Access_Fellowes Lane Junction	Crossroads	Two-way	Two-way	Two-way	Two-way		0.90	A

Junction Network

Driving side	Lighting	Network delay (s)	Network LOS
Left	Normal/unknown	0.90	A

Arms

Arms

Arm	Name	Description	Arm type
A	Tollgate Road (S)		Major
B	Site Access		Minor
C	Tollgate Road (N)		Major
D	Fellowes Lane		Minor

Major Arm Geometry

Arm	Width of carriageway (m)	Has kerbed central reserve	Has right-turn storage	Visibility for right turn (m)	Blocks?	Blocking queue (PCU)
A - Tollgate Road (S)	6.10			44.9	✓	0.00
C - Tollgate Road (N)	6.10			44.9	✓	0.00

Geometries for Arm C are measured opposite Arm B. Geometries for Arm A (if relevant) are measured opposite Arm D.

Minor Arm Geometry

Arm	Minor arm type	Lane width (m)	Width at give-way (m)	Width at 5m (m)	Width at 10m (m)	Width at 15m (m)	Width at 20m (m)	Estimate flare length	Flare length (PCU)	Visibility to left (m)	Visibility to right (m)
B - Site Access	One lane plus flare		9.80	3.30	3.00	3.00	3.00		1.00	32	37
D - Fellowes Lane	One lane	2.20								0	0

Slope / Intercept / Capacity

Priority Intersection Slopes and Intercepts

Stream	Intercept (Veh/hr)	Slope for A-B	Slope for A-C	Slope for A-D	Slope for B-A	Slope for B-C	Slope for B-D	Slope for C-A	Slope for C-B	Slope for C-D	Slope for D-A	Slope for D-B	Slope for D-C
A-D	600	-	-	-	-	-	-	0.231	0.331	0.231	-	-	-
B-A	597	0.108	0.274	0.274	-	-	-	0.172	0.391	-	0.274	0.274	0.137
B-C	677	0.103	0.261	-	-	-	-	-	-	-	-	-	-
B-D, nearside lane	529	0.096	0.243	0.243	-	-	-	0.153	0.347	0.153	-	-	-
B-D, offside lane	597	0.108	0.274	0.274	-	-	-	0.172	0.391	0.172	-	-	-
C-B	600	0.231	0.231	0.331	-	-	-	-	-	-	-	-	-
D-A	574	-	-	-	-	-	-	0.221	-	0.088	-	-	-
D-B, nearside lane	440	0.127	0.127	0.288	-	-	-	0.201	0.201	0.080	-	-	-
D-B, offside lane	440	0.127	0.127	0.288	-	-	-	0.201	0.201	0.080	-	-	-
D-C	440	-	0.127	0.288	0.101	0.201	0.201	0.201	0.201	0.080	-	-	-

The slopes and intercepts shown above include custom intercept adjustments only.

Streams may be combined, in which case capacity will be adjusted.

Values are shown for the first time segment only; they may differ for subsequent time segments.

Traffic Demand

Demand Set Details

ID	Scenario name	Time Period name	Traffic profile type	Start time (HH:mm)	Finish time (HH:mm)	Time segment length (min)
D1	2027 + Dev	AM	ONE HOUR	08:00	09:30	15

Vehicle mix source	PCU Factor for a HV (PCU)
HV Percentages	2.00

Demand overview (Traffic)

Arm	Linked arm	Use O-D data	Average Demand (Veh/hr)	Scaling Factor (%)
A - Tollgate Road (S)		✓	460	100.000
B - Site Access		✓	46	100.000
C - Tollgate Road (N)		✓	329	100.000
D - Fellowes Lane		✓	18	100.000

Origin-Destination Data

Demand (Veh/hr)

	To				
	A - Tollgate Road (S)	B - Site Access	C - Tollgate Road (N)	D - Fellowes Lane	
From	A - Tollgate Road (S)	0	6	452	2
	B - Site Access	15	0	31	0
	C - Tollgate Road (N)	302	14	0	13
	D - Fellowes Lane	0	0	18	0

Vehicle Mix

Heavy Vehicle Percentages

	To				
	A - Tollgate Road (S)	B - Site Access	C - Tollgate Road (N)	D - Fellowes Lane	
From	A - Tollgate Road (S)	0	0	2	0
	B - Site Access	0	0	0	0
	C - Tollgate Road (N)	3	0	0	8
	D - Fellowes Lane	0	0	6	0

Results

Results Summary for whole modelled period

Stream	Max RFC	Max Delay (s)	Max Queue (Veh)	Max LOS
B-CD	0.06	7.15	0.1	A
B-AD	0.04	9.67	0.0	A
A-BCD	0.01	4.64	0.0	A
A-B				
A-C				
D-ABC	0.07	14.05	0.1	B
C-ABD	0.04	5.39	0.1	A
C-D				
C-A				

Main Results for each time segment

08:00 - 08:15

Stream	Total Demand (Veh/hr)	Capacity (Veh/hr)	RFC	Throughput (Veh/hr)	End queue (Veh)	Delay (s)	Unsignalised level of service
B-CD	23	582	0.040	23	0.0	6.437	A
B-AD	11	455	0.025	11	0.0	8.110	A
A-BCD	3	779	0.003	3	0.0	4.635	A
A-B	5			5			
A-C	339			339			
D-ABC	14	320	0.042	13	0.0	11.736	B
C-ABD	16	685	0.024	16	0.0	5.383	A
C-D	10			10			
C-A	222			222			

08:15 - 08:30

Stream	Total Demand (Veh/hr)	Capacity (Veh/hr)	RFC	Throughput (Veh/hr)	End queue (Veh)	Delay (s)	Unsignalised level of service
B-CD	28	564	0.049	28	0.1	6.717	A
B-AD	13	427	0.032	13	0.0	8.700	A
A-BCD	4	817	0.004	4	0.0	4.425	A
A-B	5			5			
A-C	405			405			
D-ABC	16	302	0.054	16	0.1	12.614	B
C-ABD	21	704	0.030	21	0.0	5.268	A
C-D	11			11			
C-A	263			263			

08:30 - 08:45

Stream	Total Demand (Veh/hr)	Capacity (Veh/hr)	RFC	Throughput (Veh/hr)	End queue (Veh)	Delay (s)	Unsignalised level of service
B-CD	34	538	0.063	34	0.1	7.145	A
B-AD	17	389	0.042	16	0.0	9.663	A
A-BCD	5	870	0.006	5	0.0	4.160	A
A-B	7			7			
A-C	495			495			
D-ABC	20	276	0.072	20	0.1	14.040	B
C-ABD	29	732	0.040	29	0.1	5.121	A
C-D	14			14			
C-A	319			319			

08:45 - 09:00

Stream	Total Demand (Veh/hr)	Capacity (Veh/hr)	RFC	Throughput (Veh/hr)	End queue (Veh)	Delay (s)	Unsignalised level of service
B-CD	34	538	0.063	34	0.1	7.145	A
B-AD	17	389	0.042	17	0.0	9.665	A
A-BCD	5	870	0.006	5	0.0	4.162	A
A-B	7			7			
A-C	495			495			
D-ABC	20	276	0.072	20	0.1	14.050	B
C-ABD	29	732	0.040	29	0.1	5.129	A
C-D	14			14			
C-A	319			319			

09:00 - 09:15

Stream	Total Demand (Veh/hr)	Capacity (Veh/hr)	RFC	Throughput (Veh/hr)	End queue (Veh)	Delay (s)	Unsignalised level of service
B-CD	28	564	0.049	28	0.1	6.722	A
B-AD	13	427	0.032	14	0.0	8.705	A
A-BCD	4	817	0.004	4	0.0	4.433	A
A-B	5			5			
A-C	405			405			
D-ABC	16	301	0.054	16	0.1	12.628	B
C-ABD	21	704	0.030	21	0.0	5.281	A
C-D	11			11			
C-A	263			263			

09:15 - 09:30

Stream	Total Demand (Veh/hr)	Capacity (Veh/hr)	RFC	Throughput (Veh/hr)	End queue (Veh)	Delay (s)	Unsignalised level of service
B-CD	23	582	0.040	23	0.0	6.444	A
B-AD	11	455	0.025	11	0.0	8.118	A
A-BCD	3	779	0.003	3	0.0	4.641	A
A-B	5			5			
A-C	339			339			
D-ABC	14	320	0.042	14	0.0	11.757	B
C-ABD	16	685	0.024	16	0.0	5.390	A
C-D	10			10			
C-A	222			222			

2027 + Dev, PM

Data Errors and Warnings

Severity	Area	Item	Description
Warning	Minor arm visibility to right	B - Site Access - Minor arm geometry	Visibility to right expected to have two components if the arm has two lanes, or two lanes in a flared section.

Junction Network

Junctions

Junction	Name	Junction type	Arm A Direction	Arm B Direction	Arm C Direction	Arm D Direction	Use circulating lanes	Junction Delay (s)	Junction LOS
1	Tollgate Rd_Site Access_Fellowes Lane Junction	Crossroads	Two-way	Two-way	Two-way	Two-way		0.79	A

Junction Network

Driving side	Lighting	Network delay (s)	Network LOS
Left	Normal/unknown	0.79	A

Traffic Demand

Demand Set Details

ID	Scenario name	Time Period name	Traffic profile type	Start time (HH:mm)	Finish time (HH:mm)	Time segment length (min)
D2	2027 + Dev	PM	ONE HOUR	17:00	18:30	15

Vehicle mix source	PCU Factor for a HV (PCU)
HV Percentages	2.00

Demand overview (Traffic)

Arm	Linked arm	Use O-D data	Average Demand (Veh/hr)	Scaling Factor (%)
A - Tollgate Road (S)		✓	330	100.000
B - Site Access		✓	25	100.000
C - Tollgate Road (N)		✓	395	100.000
D - Fellowes Lane		✓	12	100.000

Origin-Destination Data

Demand (Veh/hr)

		To			
		A - Tollgate Road (S)	B - Site Access	C - Tollgate Road (N)	D - Fellowes Lane
From	A - Tollgate Road (S)	0	14	315	1
	B - Site Access	8	0	17	0
	C - Tollgate Road (N)	345	30	0	20
	D - Fellowes Lane	2	0	10	0

Vehicle Mix

Heavy Vehicle Percentages

	To			
	A - Tollgate Road (S)	B - Site Access	C - Tollgate Road (N)	D - Fellowes Lane
From				
A - Tollgate Road (S)	0	0	1	0
B - Site Access	0	0	0	0
C - Tollgate Road (N)	1	0	0	0
D - Fellowes Lane	0	0	0	0

Results

Results Summary for whole modelled period

Stream	Max RFC	Max Delay (s)	Max Queue (Veh)	Max LOS
B-CD	0.03	6.40	0.0	A
B-AD	0.02	8.79	0.0	A
A-BCD	0.00	5.13	0.0	A
A-B				
A-C				
D-ABC	0.04	11.56	0.0	B
C-ABD	0.08	5.17	0.2	A
C-D				
C-A				

Main Results for each time segment

17:00 - 17:15

Stream	Total Demand (Veh/hr)	Capacity (Veh/hr)	RFC	Throughput (Veh/hr)	End queue (Veh)	Delay (s)	Unsignalised level of service
B-CD	13	611	0.021	13	0.0	6.012	A
B-AD	6	475	0.013	6	0.0	7.675	A
A-BCD	1	703	0.002	1	0.0	5.131	A
A-B	11			11			
A-C	237			237			
D-ABC	9	367	0.025	9	0.0	10.049	B
C-ABD	36	733	0.049	36	0.1	5.162	A
C-D	14			14			
C-A	247			247			

17:15 - 17:30

Stream	Total Demand (Veh/hr)	Capacity (Veh/hr)	RFC	Throughput (Veh/hr)	End queue (Veh)	Delay (s)	Unsignalised level of service
B-CD	15	599	0.026	15	0.0	6.170	A
B-AD	7	451	0.016	7	0.0	8.109	A
A-BCD	2	725	0.002	2	0.0	4.976	A
A-B	13			13			
A-C	283			283			
D-ABC	11	349	0.031	11	0.0	10.633	B
C-ABD	48	761	0.062	47	0.1	5.045	A
C-D	17			17			
C-A	291			291			

17:30 - 17:45

Stream	Total Demand (Veh/hr)	Capacity (Veh/hr)	RFC	Throughput (Veh/hr)	End queue (Veh)	Delay (s)	Unsignalised level of service
B-CD	19	581	0.032	19	0.0	6.403	A
B-AD	9	418	0.021	9	0.0	8.793	A
A-BCD	2	757	0.003	2	0.0	4.769	A
A-B	15			15			
A-C	346			346			
D-ABC	13	325	0.041	13	0.0	11.555	B
C-ABD	67	801	0.083	66	0.2	4.902	A
C-D	20			20			
C-A	348			348			

17:45 - 18:00

Stream	Total Demand (Veh/hr)	Capacity (Veh/hr)	RFC	Throughput (Veh/hr)	End queue (Veh)	Delay (s)	Unsignalised level of service
B-CD	19	581	0.032	19	0.0	6.403	A
B-AD	9	418	0.021	9	0.0	8.794	A
A-BCD	2	757	0.003	2	0.0	4.772	A
A-B	15			15			
A-C	346			346			
D-ABC	13	325	0.041	13	0.0	11.559	B
C-ABD	67	801	0.083	67	0.2	4.905	A
C-D	20			20			
C-A	348			348			

18:00 - 18:15

Stream	Total Demand (Veh/hr)	Capacity (Veh/hr)	RFC	Throughput (Veh/hr)	End queue (Veh)	Delay (s)	Unsignalised level of service
B-CD	15	599	0.026	15	0.0	6.171	A
B-AD	7	451	0.016	7	0.0	8.112	A
A-BCD	2	725	0.002	2	0.0	4.981	A
A-B	13			13			
A-C	283			283			
D-ABC	11	349	0.031	11	0.0	10.640	B
C-ABD	48	761	0.063	48	0.1	5.053	A
C-D	17			17			
C-A	291			291			

18:15 - 18:30

Stream	Total Demand (Veh/hr)	Capacity (Veh/hr)	RFC	Throughput (Veh/hr)	End queue (Veh)	Delay (s)	Unsignalised level of service
B-CD	13	611	0.021	13	0.0	6.015	A
B-AD	6	475	0.013	6	0.0	7.678	A
A-BCD	1	702	0.002	1	0.0	5.134	A
A-B	11			11			
A-C	237			237			
D-ABC	9	367	0.025	9	0.0	10.057	B
C-ABD	36	733	0.049	36	0.1	5.171	A
C-D	14			14			
C-A	247			247			

Contact

RPS Consulting Services Ltd
20 Farringdon Street
London EC4A 4AB
T: +44(0) 20 3691 0500
transport@rpsgroup.com